



NOT LEGAL FOR SALE OR USE ON ANY POLLUTION CONTROLLED MOTOR VEHICLE IN CALIFORNIA OR STATES ADOPTING CALIFORNIA EMISSION PROCEDURES.  
See knfilters.com for CARB status on each part for a specific vehicle

# INSTALLATION INSTRUCTIONS

## 77-3076KTK CHEVROLET / GMC 2011-13 2500HD / 3500HD V8-6.0L

NOTE: This kit was not designed to fit vehicles with a body lift.

### TOOLS NEEDED:

- Ratchet
- Extension
- 10mm socket
- Flat blade screw driver
- Phillips screw driver
- t15 torx
- 9/16" wrench
- 4mm Allen
- 3mm allen

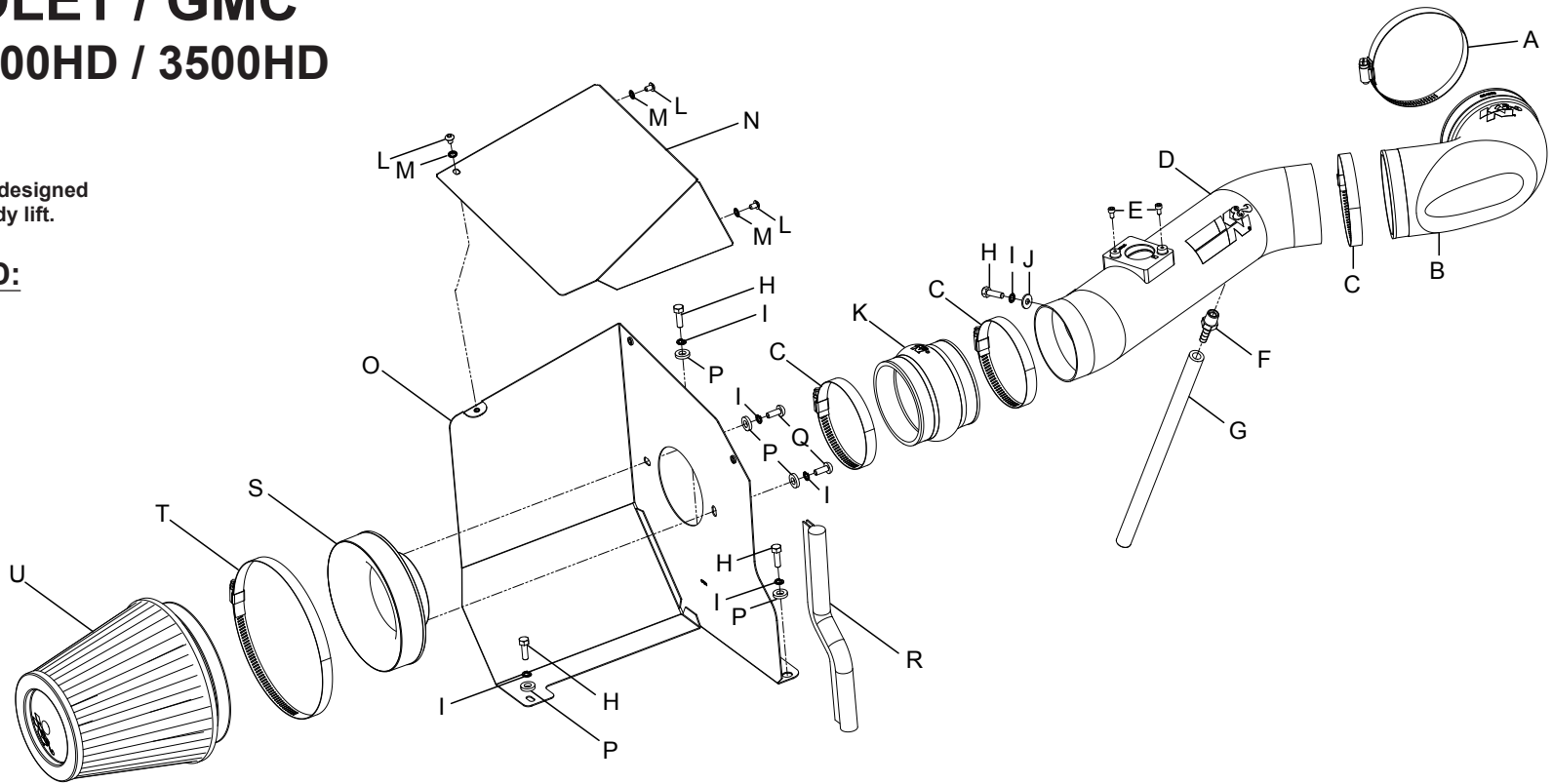

### PARTS LIST:

Description	Qty.	Part #	Description	Qty.	Part #
A Hose Clamp #64 Stainless	1	08645	L Bolt; M5 X .8 X 8MM, Buttonhead, SS	3	07740
B Hose; 4" To 3-1/2"ID 106DEG Angled Molded	1	084053	M Washer;5MM Internal Star Cut Lock	3	07724
C Hose Clamp #56	3	08620	N Heat Shield Lid	1	074093
D Intake Tube	1	27572TK	O Heat Shield	1	07384
E Bolt; M4-0.07 8MM, A/H Cap, SS	2	07733	P Washer; 1/4"ID X 5/8" OD- SAE	5	08275
F Vent; STRT, 3/8" Hose, 1/4" NPT, PLAS	1	08047	Q Bolt; M6 X 1.00 X 16MM, Buttonhead, SS	2	07730
G Hose 3/8" ID X 12"L	1	08412	R Edge Trim (11")	1	102468
H Bolt; M6 X 1.00" X 20MM Hex, SS	4	07795	S Adapter; Universal, 6" Filter 3.5" Coupler	1	21512-1
I Washer; M6 Split Lock Zinc	6	1-3025	T Hose Clamp # 104	1	08697
J Washer; 6MM Flat, SS	1	08269	U Air filter	1	RF-1042XD
K Hose; 3-1/2"ID X 3" L Hump Molded	1	084057			

**NOTE: FAILURE TO FOLLOW INSTALLATION INSTRUCTIONS AND NOT USING THE PROVIDED HARDWARE MAY DAMAGE THE INTAKE TUBE, THROTTLE BODY AND ENGINE.**

### TO START:

1. Turn off the ignition and disconnect the negative battery cable.  
**NOTE: Disconnecting the negative battery cable erases pre-programmed electronic memories. Write down all memory settings before disconnecting the negative battery cable. Some radios will require an anti-theft code to be entered after the battery is reconnected. The anti-theft code is typically supplied with your owner's manual. In the event your vehicles' anti-theft code cannot be recovered, contact an authorized dealership to obtain your vehicles anti-theft code.**

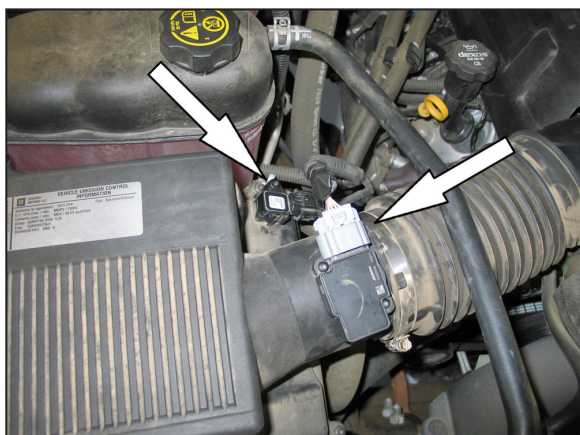

2. Disconnect the mass air sensor and pressure sensor electrical connections shown.



3. Lift up and remove the engine cover as shown.



4. Disconnect the crank case vent hose from the intake tube plenum.

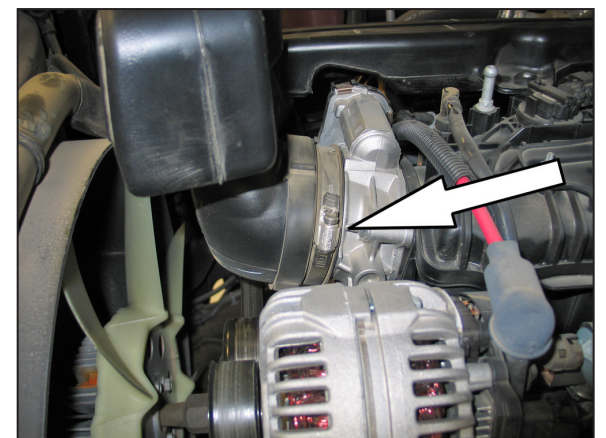

5. Loosen the hose clamp securing the intake tube to the throttle body.

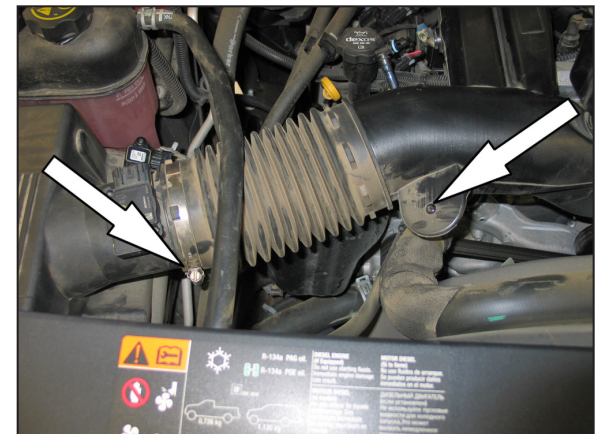

6. Loosen the hose clamp securing the intake tube to the air box housing and disconnect the radiator hose retaining clip from the intake tube. Then remove the intake tube from the vehicle.

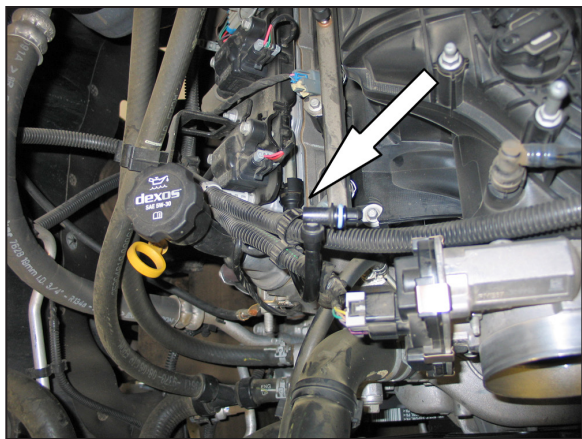

7. Rotate the crank case vent hose counter clockwise to access the retaining clip on the valve cover, release the clip and then remove the hose from the valve cover port.

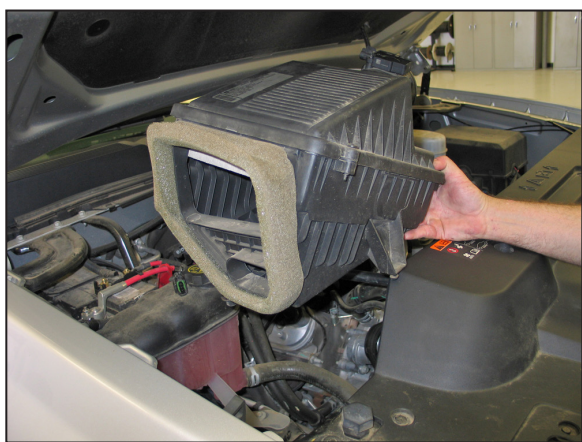

8. Lift up and remove the factory air box from the vehicle.

**NOTE: K&N Engineering, Inc., recommends that customers do not discard factory air intake**

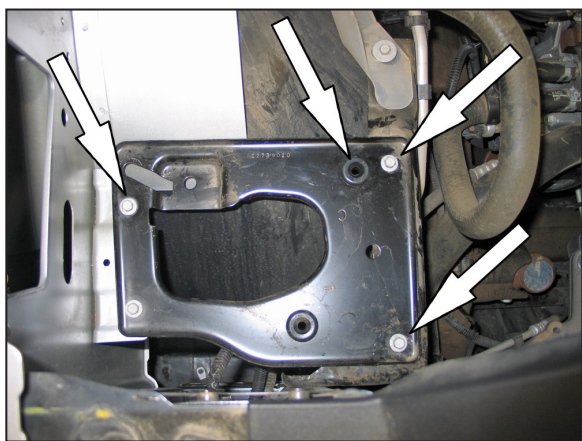

9. Remove the three bolts shown and the rubber grommet shown from the air box mounting plate.

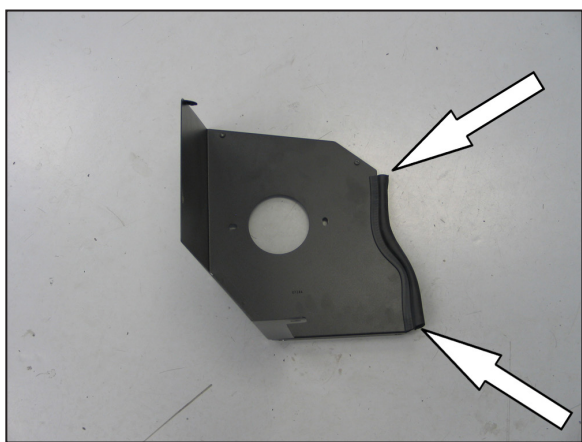

10. Install the provided edge trim onto the heat shield as shown.

**NOTE: Some trimming of the edge trim will be necessary.**

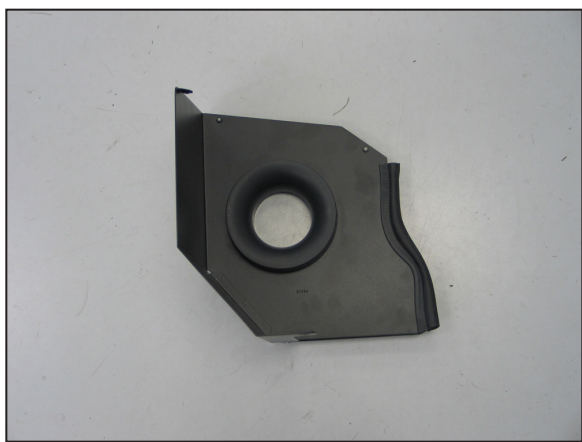

11. Install the provided filter adapter into the heat shield and secure with the provided hardware.

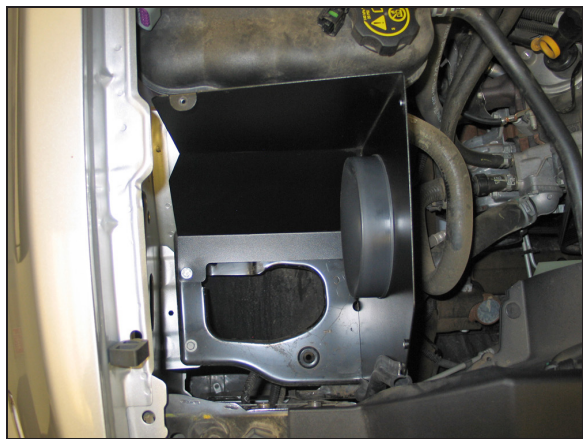

12. Install the heat shield onto the air box mounting plate and secure with the provided hardware to the factory mounting locations.

**NOTE: It may be necessary to loosen the bolt securing the coolant reservoir and adjust the mounting bracket.**

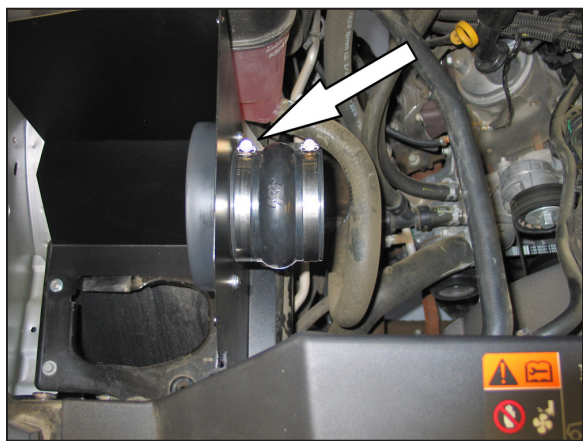

13. Install the provided hump hose (084057) onto the radius adapter and secure with the provided hose clamp.

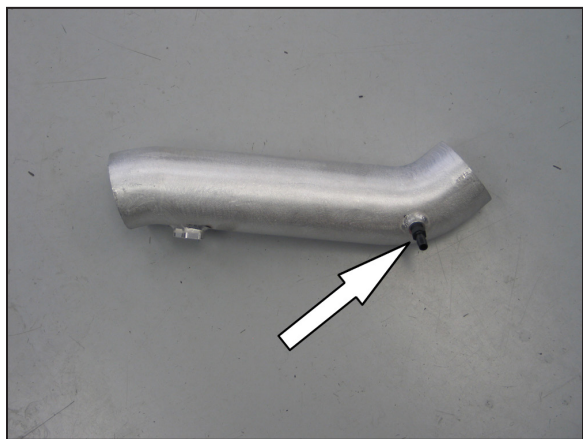

14. Install the provided NPT vent fitting into the K&N intake tube as shown.



15. Remove the screws securing the mass air sensor and pressure sensor into the factory air box lid and then remove the sensors.



16. Install the sensors into the K&N intake tube and secure with the provided hardware.



17. Install the provided angle hose onto the K&N intake tube as shown.

**NOTE: Do not tighten the hose clamp at this time.**



18. Install the K&N intake tube assembly onto the filter adapter and then the throttle body. Adjust the tube and hose for proper fit and then tighten the hose clamps.

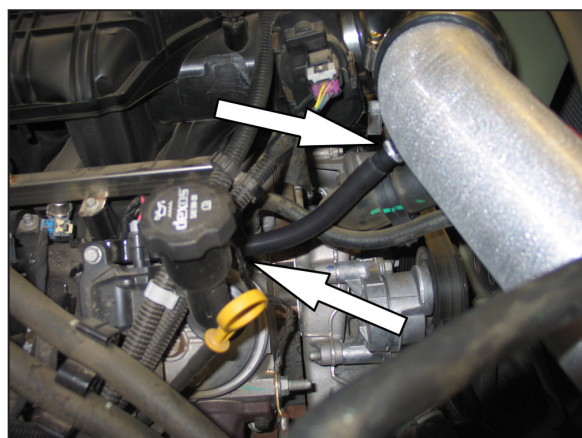

19. Connect the provided crank case vent hose the fitting installed into the K&N intake tube and then connect the open end to the valve cover port.

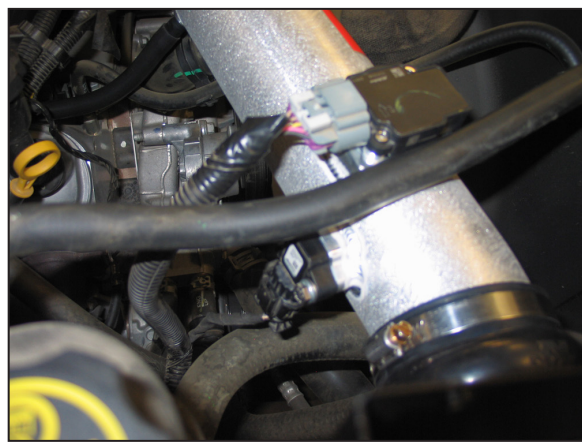

20. Connect the mass air sensor and pressure sensor electrical connections.



21. Install the K&N air filter and secure with the provided hose clamp.

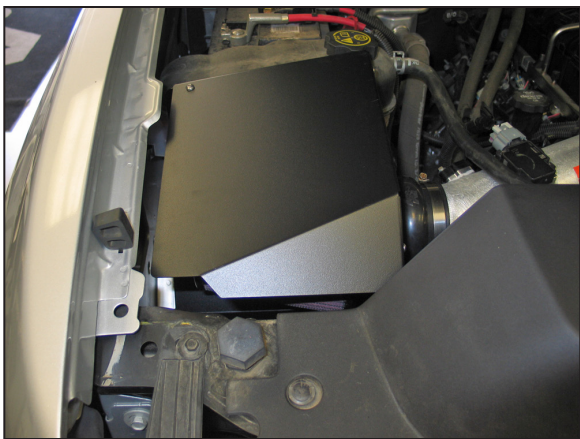

22. Install the air box lid and secure with the provided hardware.



23. Reinstall the engine cover.



24. Reconnect the vehicle's negative battery cable. Double check to make sure everything is tight and properly positioned before starting the vehicle.

25. It will be necessary for all K&N® high flow intake systems to be checked periodically for realignment, clearance and tightening of all connections. Failure to follow the above instructions or proper maintenance may void warranty.

#### ROAD TESTING:

1. Start the engine with the transmission in neutral or park, and the parking brake engaged. Listen for air leaks or odd noises. For air leaks secure hoses and connections. For odd noises, find cause and repair before proceeding. This kit will function identically to the factory system except for being louder and much more responsive.

2. Test drive the vehicle. Listen for odd noises or rattles and fix as necessary.

3. If road test is fine, you can now enjoy the added power and performance from your kit.

4. K&N Engineering, Inc., requires cleaning the intake system's air filter element every 100,000 miles. When used in dusty or off-road environments, our filters will require cleaning more often. We recommend that you visually inspect your filter once every 25,000 miles to determine if the screen is still visible. When the screen is no longer visible some place on the filter element, it is time to clean it. To clean and re-oil, purchase our filter Recharger® service kit, part number 99-5050 or 99-5000 and follow the easy instructions.

**NOT LEGAL FOR SALE OR USE ON ANY POLLUTION CONTROLLED MOTOR VEHICLE IN CALIFORNIA OR STATES ADOPTING CALIFORNIA EMISSION PROCEDURES.**

See [knfilters.com](http://knfilters.com) for CARB status on each part for a specific vehicle