



LEGAL IN CALIFORNIA ONLY FOR RACING VEHICLES WHICH MAY NEVER BE USED, REGISTERED OR LICENSED FOR USE UPON A HIGHWAY.
See knfilters.com for CARB status on each part for a specific vehicle

INSTALLATION INSTRUCTIONS

77-3071KS CHEVROLET / GMC 2010-15 Equinox 2010-14 Terrain L4-2.4L

NOTE: This kit was not designed to fit vehicles with a body lift.

TOOLS NEEDED:

Ratchet
Extension
T25 torx
5.5mm Socket
Flat Blade Screwdriver
3mm Allen Wrench
5mm Allen Wrench

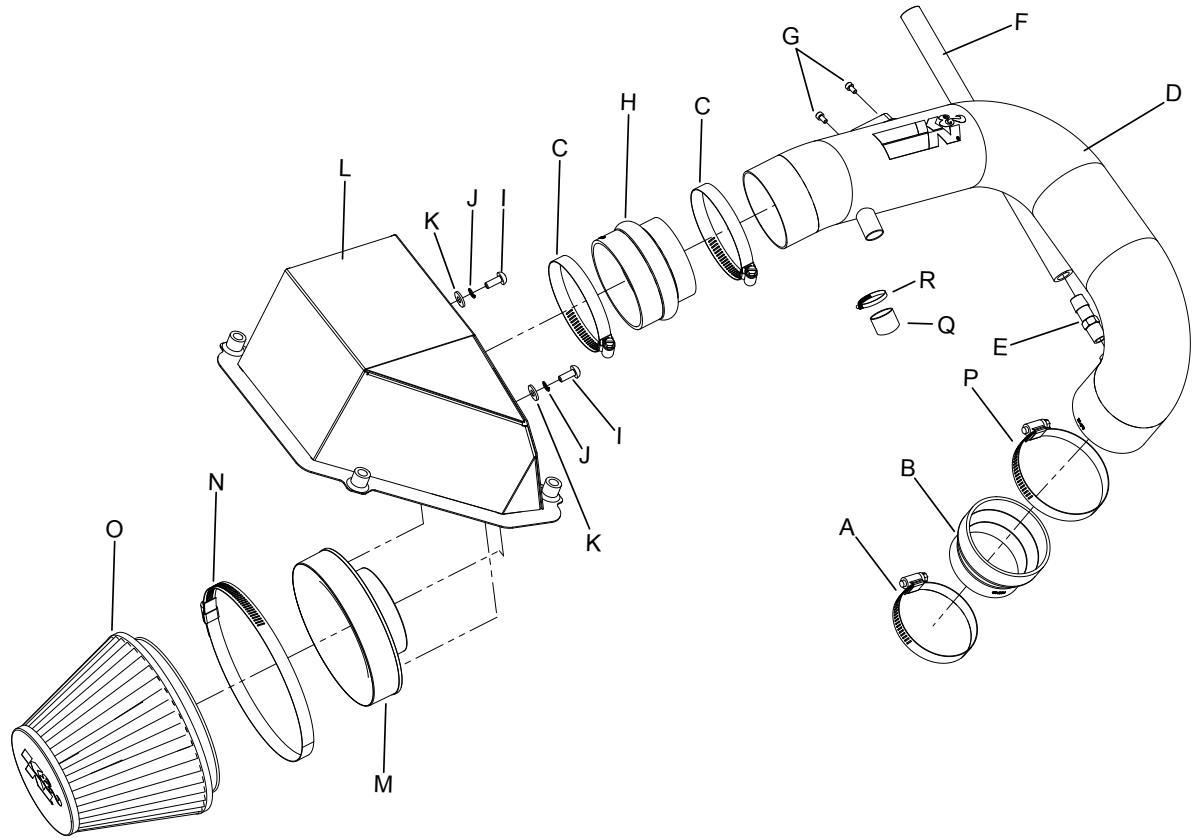

PARTS LIST:

Description	Qty.	Part #	Description	Qty.	Part #
A Hose Clamp #44 Stainless	1	08560	J Washer; 1/4" Lock, ZN	2	08198
B Hose; 3-1/4" TO 2-3/4" ID X 2"	1	084034	K Washer; 1/4" ID X 5/8" OD - SAE	2	08275
C Hose Clamp #52	2	08610	L Heat Shield	1	074075
D Intake Tube	1	27478-1KS	M Adapter; Universal, 6"	1	21512-1
E Vent; Strt. 1/2" Hose, 1/4"NPT	1	080022	N Hose Clamp #104	1	08697
F Hose; 1/2" ID X 12" L	1	087031	O Air Filter	1	RC-5138
G Bolt; M4 - 0.07 8MM, A/H CAP, SS	2	07733	P Hose Clamp #56	1	08620
H Hose, Hump 3.25/3.50 X3.00"	1	5-576	Q Cap	1	08246
I Bolt; M6 X 1.00 X 16MM, BH, SS	2	07730	R Hose Clamp #20	1	08436

NOTE: FAILURE TO FOLLOW INSTALLATION INSTRUCTIONS AND NOT USING THE PROVIDED HARDWARE MAY DAMAGE THE INTAKE TUBE, THROTTLE BODY AND ENGINE.

TO START:

- Turn off the ignition and disconnect the negative battery cable.
NOTE: Disconnecting the negative battery cable erases pre-programmed electronic memories. Write down all memory settings before disconnecting the negative battery cable. Some radios will require an anti-theft code to be entered after the battery is reconnected. The anti-theft code is typically supplied with your owner's manual. In the event your vehicles' anti-theft code cannot be recovered, contact an authorized dealership to obtain your vehicles anti-theft code.

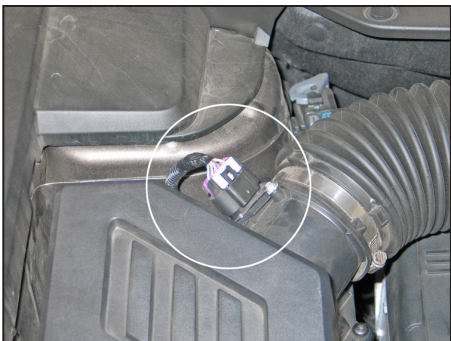

- Disconnect the mass air sensor electrical connection.

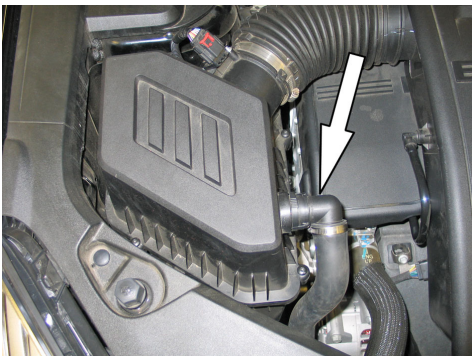

- On vehicles equipped with an air injection system, cut the clamp securing the air injection hose to the fitting on the upper air box and disconnect the hose from the fitting.



- Disconnect the crankcase vent tube from the intake plenum as shown.

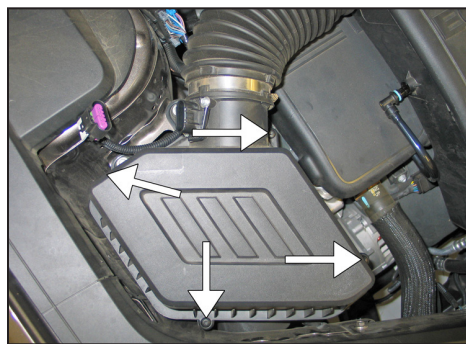

- Loosen the four screws that secure the upper airbox to the lower airbox.

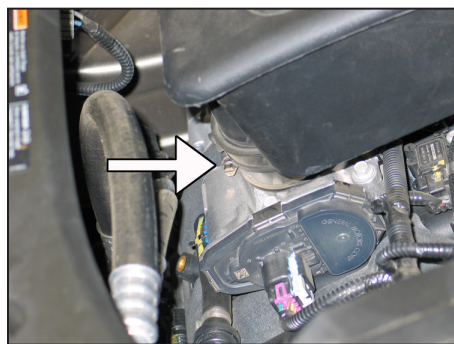

- Loosen the hose clamp securing the intake plenum to the throttle body.



- Remove the intake plenum and upper airbox from the vehicle.

NOTE: K&N Engineering, Inc., recommends that customers do not discard factory air intake.



- Remove the air filter from the lower airbox.



- Remove the crankcase vent hose from the valve cover port.

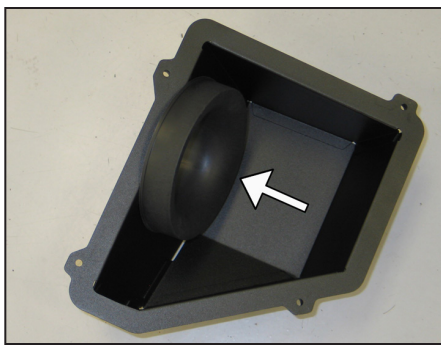

9. Install the provided filter adapter into the K&N® upper airbox and secure with the provided hardware.

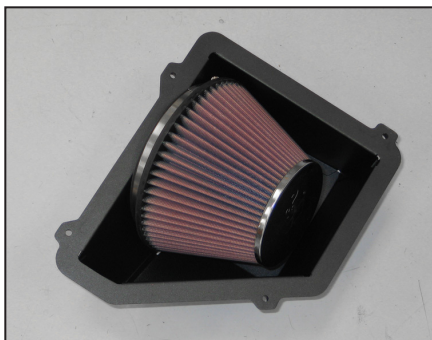

10. Install the K&N® air filter onto the filter adapter and secure with the provided hose clamp.



11. Set the K&N® upper airbox assembly onto the factory lower airbox as shown.



12. Remove the four upper airbox retaining screws from the factory upper airbox.

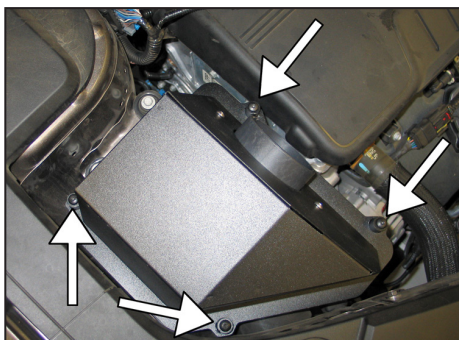

13. Secure the K&N® upper airbox with the four screws removed in the previous step.



14. Install the provided silicone hose (084034) onto the throttle body and secure with the provided hose clamp.

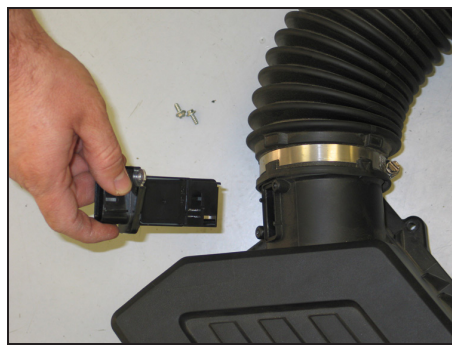

15. Remove the two screws securing the mass air sensor into the factory airbox and then remove the mass air sensor.

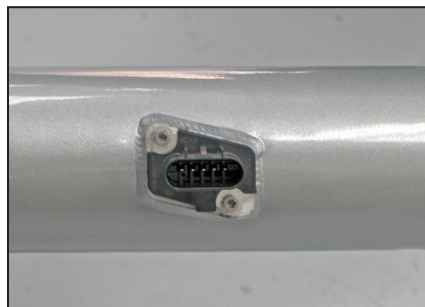

16. Install the mass air sensor into the K&N® intake tube and secure with the provided hardware.



17. Install the provided vent fitting into the K&N® intake tube as shown.

NOTE: Plastic NPT fittings are easy to cross thread. Install the vent fitting "hand" tight, then turn it two complete turns with a wrench.



18. Install the provided silicone hose (5-576) onto the K&N® intake tube as shown.

NOTE: Do not tighten the hose clamp at this time.



19. Install the K&N® intake tube assembly onto the filter adapter. Using a twisting motion, push the intake tube into the silicone hose until the tube lines up with the silicone hose on the throttle body. Secure the intake tube with the provided hose clamps. On vehicles equipped with air injection, install the air injection hose to the fitting on the K&N® intake tube and secure it with the provided hose clamp. On vehicles with out air injection, install the provided cap and secure it with the provided hose clamp.

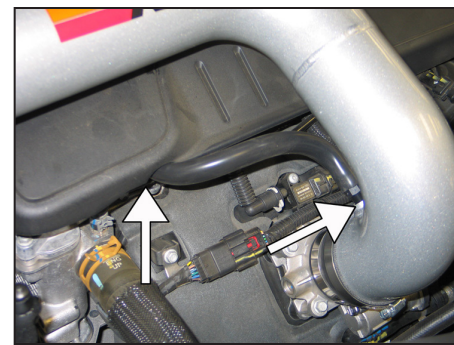

20. Install the provided crankcase vent hose onto the port on the valve cover and then attach the open end onto the vent fitting attached to the intake tube.



21. Reconnect the mass air sensor electrical connection.



22. Reconnect the vehicle's negative battery cable. Double check to make sure everything is tight and properly positioned before starting the vehicle.

23. It will be necessary for all K&N® high flow intake systems to be checked periodically for realignment, clearance and tightening of all connections. Failure to follow the above instructions or proper maintenance may void warranty.

ROAD TESTING:

1. Start the engine with the transmission in neutral or park, and the parking brake engaged. Listen for air leaks or odd noises. For air leaks secure hoses and connections. For odd noises, find cause and repair before proceeding. This kit will function identically to the factory system except for being louder and much more responsive.

2. Test drive the vehicle. Listen for odd noises or rattles and fix as necessary.

3. If road test is fine, you can now enjoy the added power and performance from your kit.

4. K&N Engineering, Inc., suggests checking the air filter element periodically for excessive dirt build-up. When the element becomes covered in dirt (or once a year), service it according to the instructions on the Recharger® service kit, part number 99-5050 or 99-5000.

LEGAL IN CALIFORNIA ONLY FOR RACING VEHICLES WHICH MAY NEVER BE USED, REGISTERED OR LICENSED FOR USE UPON A HIGHWAY.

See knfilters.com for CARB status on each part for a specific vehicle