



NOT LEGAL FOR SALE OR USE ON ANY POLLUTION CONTROLLED MOTOR VEHICLE IN CALIFORNIA OR STATES ADOPTING CALIFORNIA EMISSION PROCEDURES.

See knfilters.com for CARB status on each part for a specific vehicle

INSTALLATION INSTRUCTIONS

77-2582KTK

FORD

2011-15 F250 / F350 Super Duty

V8-6.2L

NOTE: This kit was not designed to fit vehicles with a body lift.

TOOLS NEEDED:

3mm Allen Wrench
4mm Allen Wrench
8mm Socket
10mm Socket
Extension
Flat Blade Screwdriver
Ratchet
T20 Torx Wrench

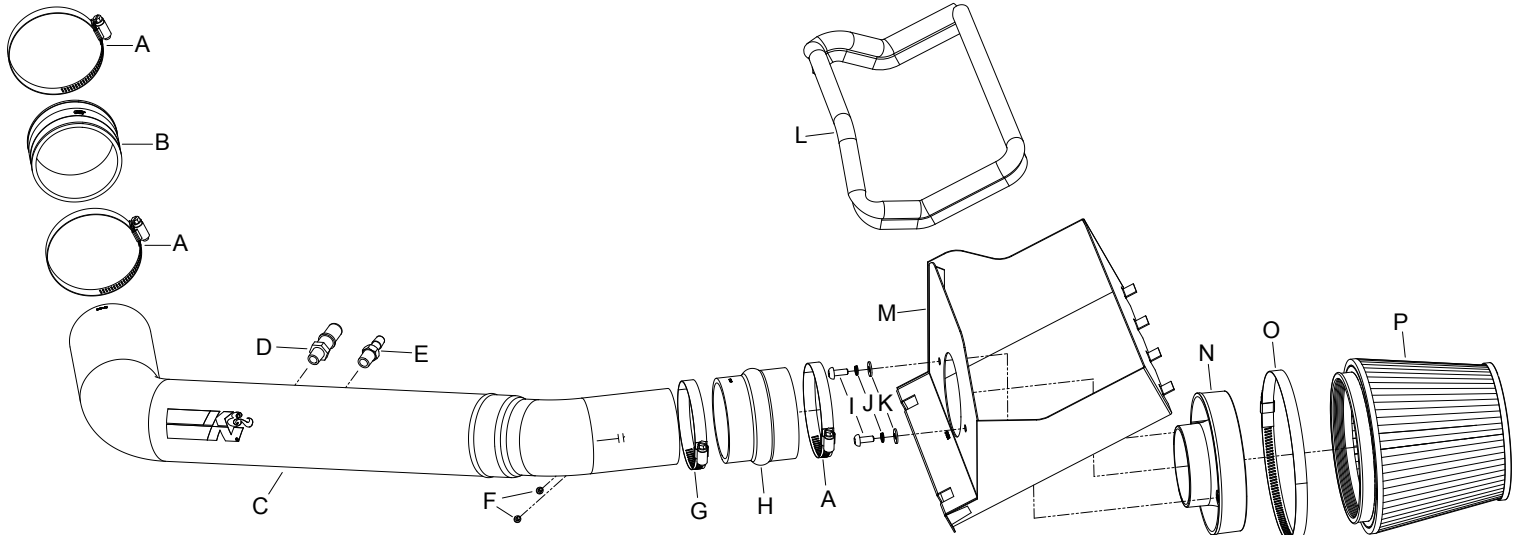

PARTS LIST:

Description	Qty.	Part #	Description	Qty.	Part #	Description	Qty.	Part #
A Hose Clamp #56	3	08620	G Hose Clamp #52	1	08610	L Edge Trim (35")	1	102471
B Hose; 3-1/2" ID X 2" L Molded	1	08630	H Hose; Hump 3.25/3.50 X 3.00"	1	5-576	M Heat Shield	1	074076
C Intake Tube	1	27498	I Bolt; M6 X 1.00 X 16MM, SS	2	07730	N Adapter; Universal, 6" Filter 3.5"	1	21512-1
D Vent; 1/4 NPT to Quick Dis.	1	082628	J Washer, M6 Split Lock Zinc	2	1-3025	O Hose Clamp #104	1	08697
E Vent; STRT, 3/8" Hose, 1/4" NPT	1	08047	K Washer; 6MM Flat, SS	2	08269	P Air Filter	1	RC-5173
F Bolt; M4-0.07 8MM, A/H Cap, SS	2	07733						

NOTE: FAILURE TO FOLLOW INSTALLATION INSTRUCTIONS AND NOT USING THE PROVIDED HARDWARE MAY DAMAGE THE INTAKE TUBE, THROTTLE BODY AND ENGINE.

TO START:

1. Turn off the ignition and disconnect the negative battery cable.

NOTE: Disconnecting the negative battery cable erases pre-programmed electronic memories. Write down all memory settings before disconnecting the negative battery cable. Some radios will require an anti-theft code to be entered after the battery is reconnected. The anti-theft code is typically supplied with your owner's manual. In the event your vehicles' anti-theft code cannot be recovered, contact an authorized dealership to obtain your vehicles anti-theft code.



2. Disconnect the mass air sensor electrical connection.

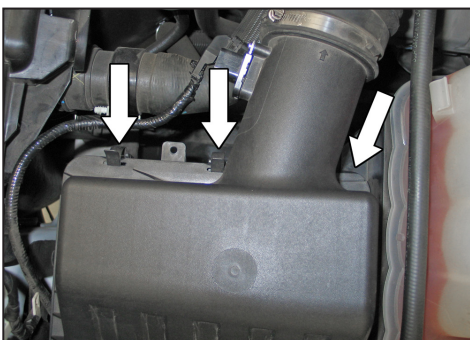

3. Release the three upper air box retaining clips.

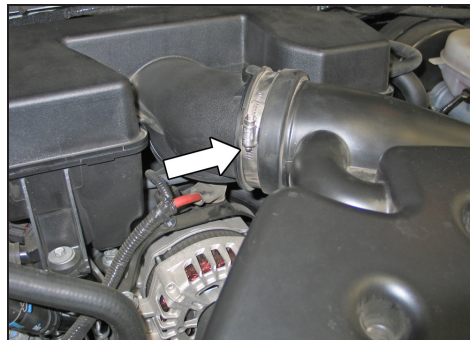

4. Loosen the hose clamp securing the intake tube to the intake plenum.



5. Remove the stock intake tube, upper air box and air filter from the vehicle.

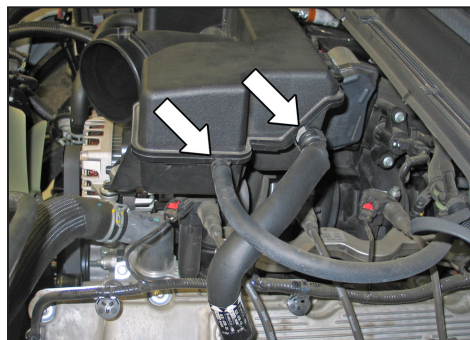

6. Disconnect the crank case vent line and EVAP vent line from the intake plenum.

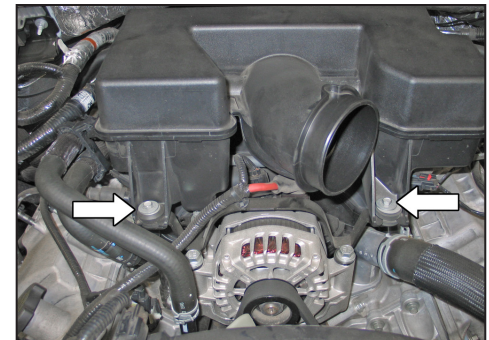

7. Remove the two bolts securing the intake plenum to the intake manifold and then loosen the hose clamp securing the plenum to the throttle body.

NOTE: 2014 model year and later vehicles have a slightly different plenum that is not bolted on.



8. Unhook the heater hose clip from the intake plenum and then remove the plenum from the vehicle.

NOTE: K&N Engineering, Inc., recommends that customers do not discard factory air intake.

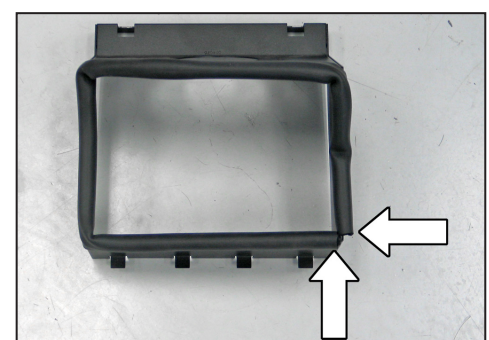

9. Install the provided edge trim onto the heat shield as shown.

NOTE: Some trimming of the edge trim will be necessary.



10. Install the filter adapter into the heat shield and secure with the provided hardware.



11. Install the K&N® air filter onto the filter adapter and secure with the provided hose clamp.
NOTE: Drycharger® air filter wrap; part # RC-5173DK is available to purchase separately. To learn more about Drycharger® filter wraps or look up color availability please visit <http://www.knfilters.com>.

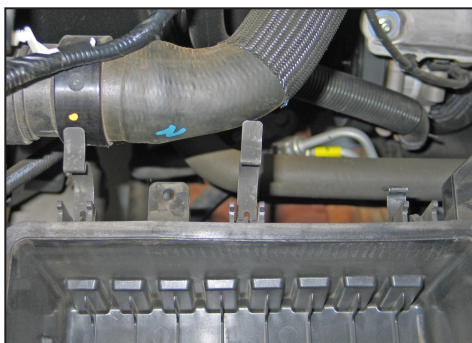

12. Remove the center upper air box retaining clip from the lower air box.



13. Install the K&N® filter/heat shield assembly and secure with the two remaining factory upper air box retaining clips.

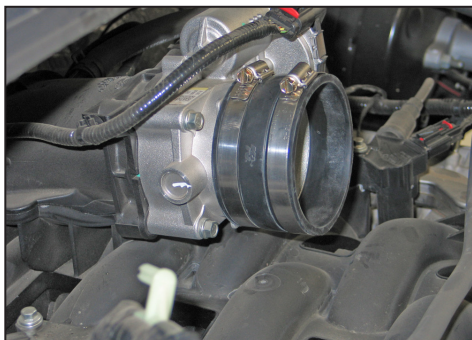

14. Install the provided silicone hose (08630) onto the throttle body and secure with the provided hose clamp.



15. Install the provided silicone hump hose (5-576) onto the filter adapter and secure with the provided hose clamp.

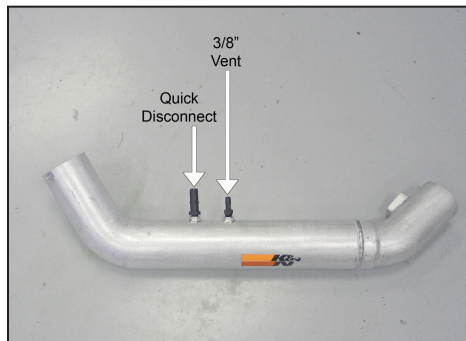

16. Install the quick disconnect and 3/8 NPT vent fittings into K&N® intake tube as shown.
NOTE: Plastic NPT fittings are easy to cross thread. Install the vent fitting "hand" tight, then turn it two complete turns with a wrench.



17. Remove the mass air sensor from the factory air box.



18. Install the mass air sensor into the K&N® intake tube and secure with the provided hardware.



19. Install the K&N® intake tube into the silicone hose at the air filter and then into the silicone hose at the throttle body and secure with the provided hose clamps.

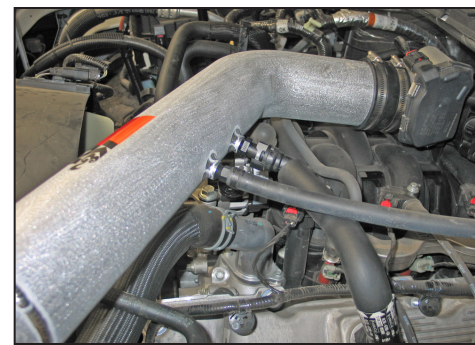

20. Connect the crank case vent hose and EVAP vent hose to the K&N® intake tube.

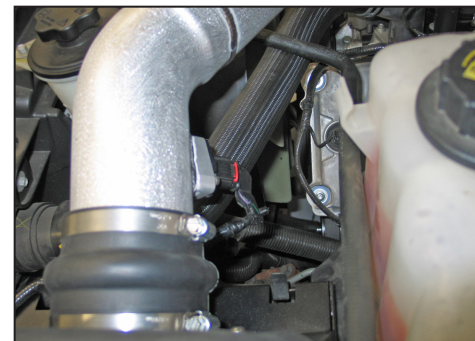

21. Reconnect the mass air sensor electrical connection.



22. Reconnect the vehicle's negative battery cable. Double check to make sure everything is tight and properly positioned before starting the vehicle.

23. It will be necessary for all K&N® high flow intake systems to be checked periodically for realignment, clearance and tightening of all connections. Failure to follow the above instructions or proper maintenance may void warranty.

ROAD TESTING:

1. Start the engine with the transmission in neutral or park, and the parking brake engaged. Listen for air leaks or odd noises. For air leaks secure hoses and connections. For odd noises, find cause and repair before proceeding. This kit will function identically to the factory system except for being louder and much more responsive.

2. Test drive the vehicle. Listen for odd noises or rattles and fix as necessary.

3. If road test is fine, you can now enjoy the added power and performance from your kit.

4. K&N Engineering, Inc., requires cleaning the intake system's air filter element every 100,000 miles. When used in dusty or off-road environments, our filters will require cleaning more often. We recommend that you visually inspect your filter once every 25,000 miles to determine if the screen is still visible. When the screen is no longer visible some place on the filter element, it is time to clean it. To clean and re-oil, purchase our filter Recharger® service kit, part number 99-5050 or 99-5000 and follow the easy instructions.

NOT LEGAL FOR SALE OR USE ON ANY POLLUTION CONTROLLED MOTOR VEHICLE IN CALIFORNIA OR STATES ADOPTING CALIFORNIA EMISSION PROCEDURES.

See knfilters.com for CARB status on each part for a specific vehicle