



INTAKE SYSTEMS FOR VEHICLES LISTED ARE 90 STATE LEGAL. SEE KNFILTERS.COM FOR CARB STATUS ON EACH PART FOR A SPECIFIC VEHICLE.

INSTALLATION INSTRUCTIONS

77-2573KP
FORD
2006-08 Explorer
V8-4.6L

NOTE: This kit was not designed to fit vehicles with a body lift.

TOOLS NEEDED:

- Flatblade Screwdriver
- Ratchet
- Extension
- 10mm Socket
- 13mm Socket
- 2.5mm Allen Wrench

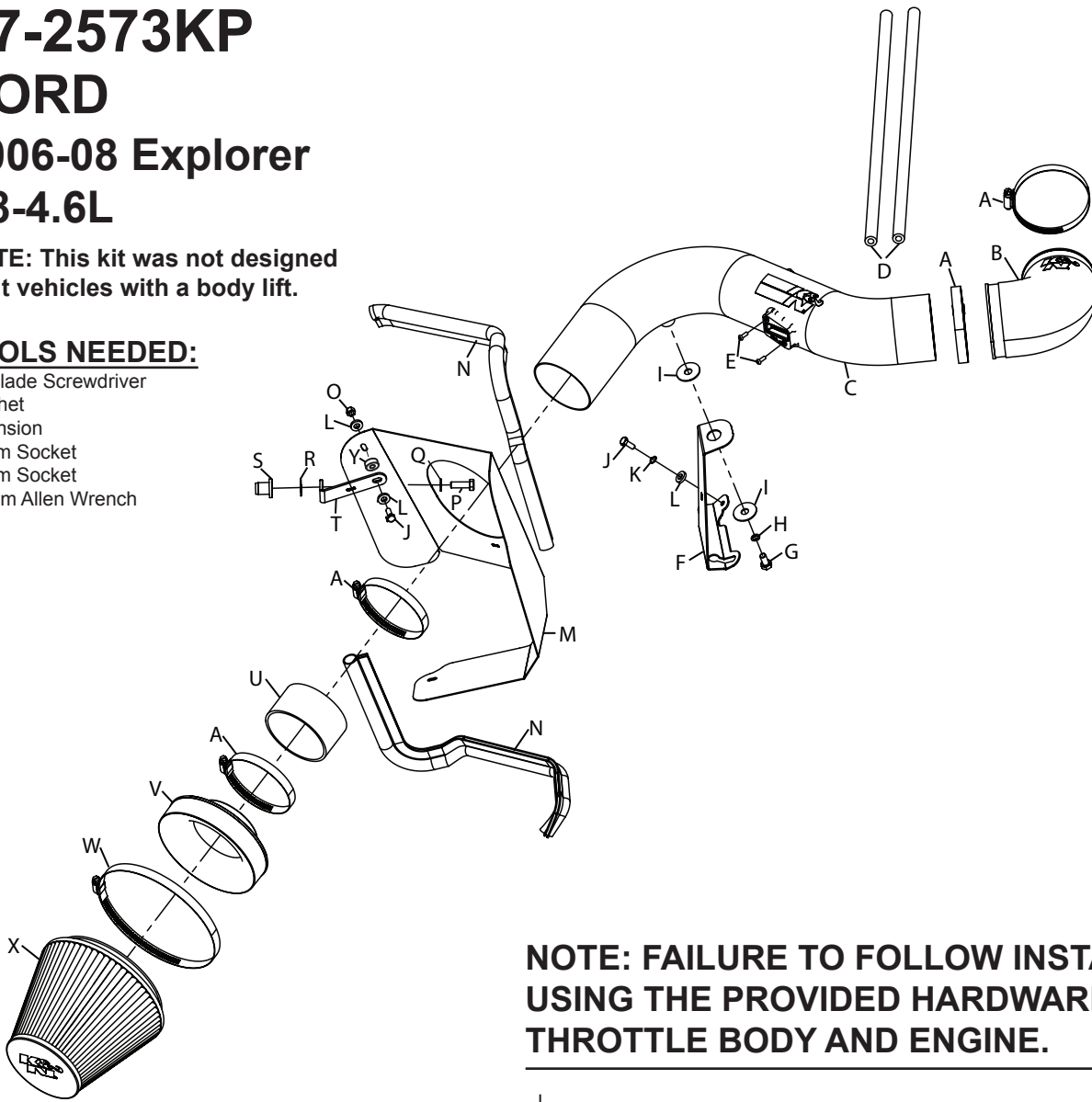

PARTS LIST:

Description	Qty.	Part #
A	Hose Clamp #56	4 08620
B	Hose; 3-1/2"ID, angled, silicone	1 084088
C	Intake tube	1 27527
D	Hose; 5/16"ID X 21"L, silicone	2 08409
E	Screw; M4-.7 X 12, buttonhead ss	2 07726
F	Bracket; stl. fb/pc	1 06482
G	Bolt; M8-1.0 X 20MM, tap	1 06533
H	Washer; 8MM spring (wave)	1 08239
I	Washer; 1.25"OD X .40"ID X .062 thk, zn	2 08126
J	Bolt; 6MM-1.00 X 16MM, ss	2 07812
K	Washer; 1/4" lock, zn	1 08198
L	Washer; 1/4"ID X 5/8"OD - sae	3 08275
M	Heat shield	1 07648
N	Edge trim	2 102495
O	Nut; 6MM nylock, hexhead	1 07553
P	Bolt; 5/16"- 18 X 1"L,ss	1 07777
Q	Washer; 5/16"ID X 5/8"OD, flat	1 08276
R	Washer; 3/8" flat, ss	1 08134
S	Insert; 5/16-18 X .600 OD X .730L rubber	1 088002
T	Bracket; "L", stl, fb/pc	1 06483
U	Hose; 3.5"ID X 2"L, silicone	1 08630
V	Adapter; #380	1 21512
W	Hose Clamp #104	1 08697
X	Air Filter	1 RF-1048
Y	Spacer;.625"ODX.250"IDX.250"L	1 06555

NOTE: FAILURE TO FOLLOW INSTALLATION INSTRUCTIONS AND NOT USING THE PROVIDED HARDWARE MAY DAMAGE THE INTAKE TUBE, THROTTLE BODY AND ENGINE.

TO START:

1. Turn off the ignition and disconnect the negative battery cable.
NOTE: Disconnecting the negative battery cable erases pre-programmed electronic memories. Write down all memory settings before disconnecting the negative battery cable. Some radios will require an anti-theft code to be entered after the battery is reconnected. The anti-theft code is typically supplied with your owner's manual. In the event your vehicles' anti-theft code cannot be recovered, contact an authorized dealership to obtain your vehicles anti-theft code.

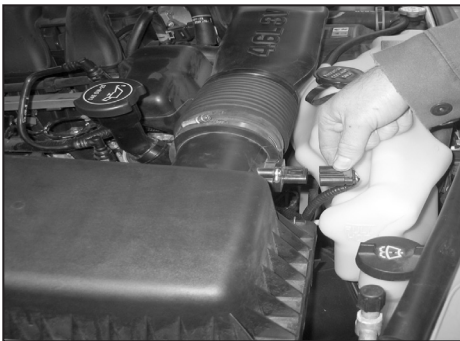

2. Disconnect the mass air sensor electrical connection.

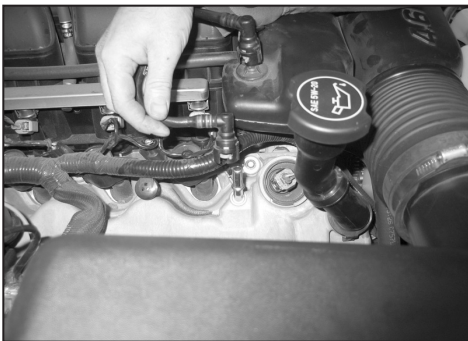

3. Disconnect the crankcase vent hose from the valve cover as shown.



5. Loosen the hose clamps that secure stock intake tube to the throttle body and airbox shown.



6. Remove the stock intake tube from the vehicle as shown.



7. Unlatch the three airbox lid latches and then remove the lid from the vehicle.



4. Disconnect the brake booster vent hose from the fitting as shown.

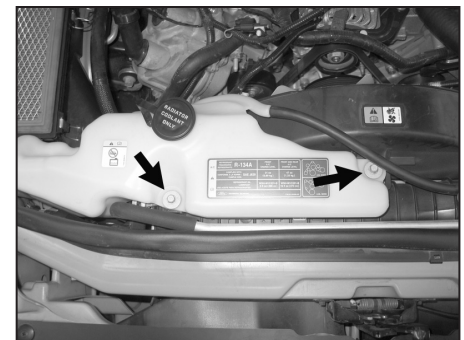

8. Loosen and remove the two bolts that secure the coolant recovery tank to the radiator.



9. Lift and position the coolant recovery tank on the engine to gain access to the lower airbox.



10. Lift up the lower airbox housing to dislodge it from the mounting grommets and then remove the lower airbox housing from the vehicle.
NOTE: K&N Engineering, Inc., recommends that customers do not discard factory air intake.



11. Reinstall the coolant recovery tank and secure with the factory bolts removed in step #8.

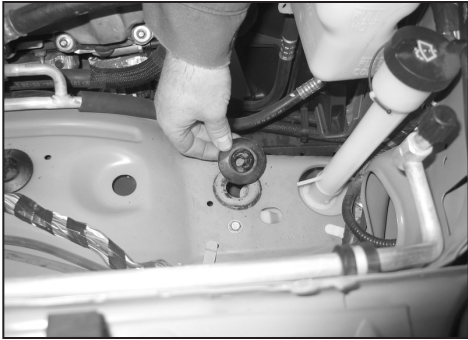

12. Remove the front lower airbox mounting grommet shown.

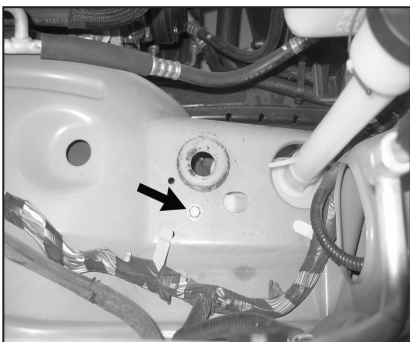

13. Remove the washer bottle mounting bolt shown.
NOTE: This bolt will be reused.

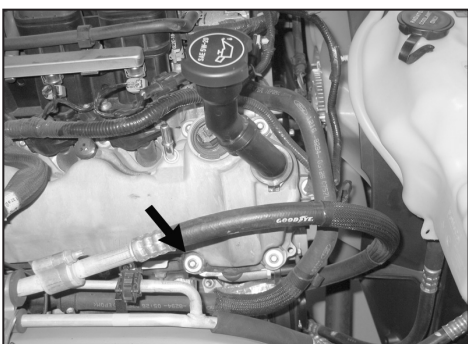

14. Remove the valve cover mounting bolt shown.
NOTE: this bolt will be reused.

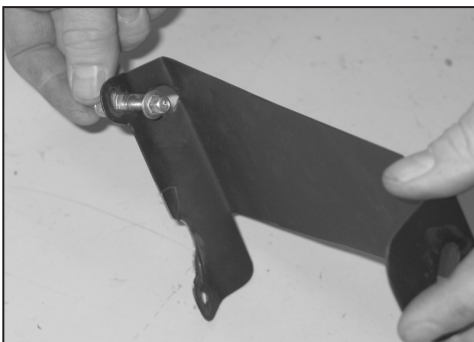

15. Insert the bolt removed in step #14 through the keyhole in the tube mounting bracket as shown.



16. Install the tube mounting bracket onto the valve cover and secure with the factory valve cover mounting bolt and the supplied hardware as shown.

NOTE: The provided bolt will thread into the threaded hole in the engine cylinder head, some vehicles will have a plastic heater hose retainer in this hole. It will be necessary to remove this retainer and secure the heater hose between the bracket and valve cover.



17. Install the supplied edge trim onto the heat shield as shown.

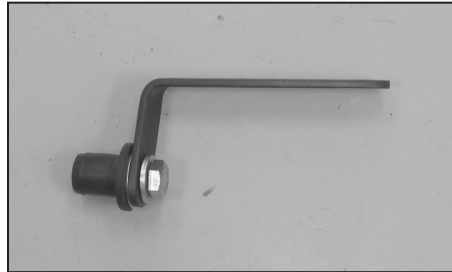

18. Attach the inserted nut to the mounting bracket with the hardware as shown.

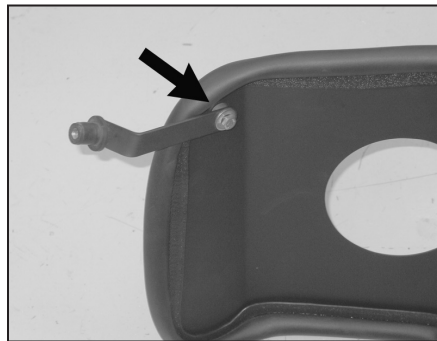

19. Attach the mounting bracket assembly to the heat shield with the provided hardware as shown.
NOTE: Be sure to position the spacer between the bracket and heat shield.

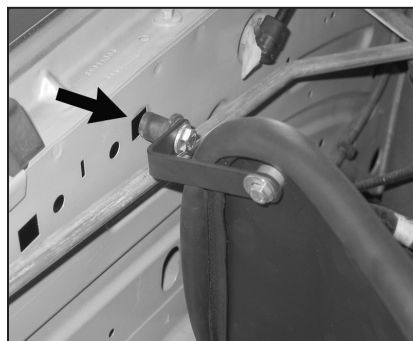

20. Install the heat shield assembly into the vehicle so that the inserted nut will fit into the hole in the inner fender panel.

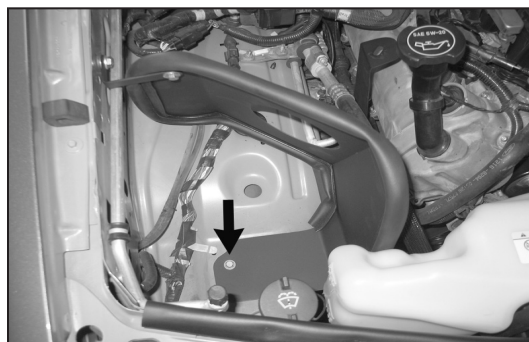

21. Secure the heat shield to the inner fender with the bolt removed in step #13 and the inserted nut and bolt.



22. Install the silicone hose (08630) onto the throttle body and secure with the provided hose clamp.

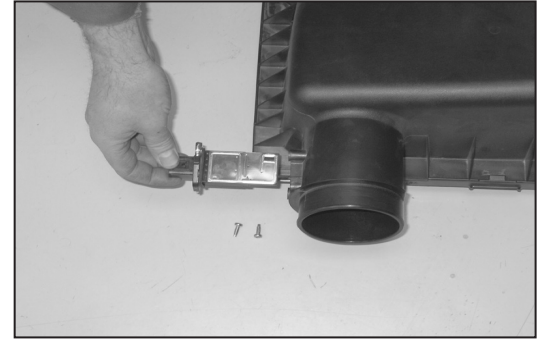

23. Remove the two screws that secure the mass air sensor to the stock airbox and then remove the mass air sensor.

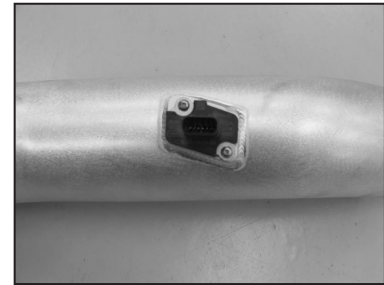

24. Install the mass air sensor assembly into the K&N® intake tube and secure with the provided hardware.



25. Install the K&N® intake tube into the silicone hose at the throttle body and align with the mounting bracket installed in step #22. Secure the intake tube with the hose clamp and supplied hardware.



26. Install the supplied shorter crankcase vent hose onto the fitting on the valve cover and then onto the on the K&N® intake tube as shown.



27. Install the supplied brake booster vent hose onto the factory fitting and then connect the other end to the fitting on the K&N® intake tube as shown.



28. Install the air filter adapter into the K&N® air filter as shown and secure with the provided hose clamp.

NOTE: Drycharger® air filter wrap; part # RF-1048DK is available to purchase separately. To learn more about Drycharger® filter wraps or look up color availability please visit <http://www.knfilters.com>®.



29. Install the silicone hose (08698) onto the air filter adapter and secure with the provided hose clamp.



30. Install the air filter assembly onto the K&N® intake tube and secure with the provided hose clamp.



31. Reconnect the mass air sensor electrical connection.



32. Reconnect the vehicle's negative battery cable. Double check to make sure everything is tight and properly positioned before starting the vehicle.

33. The C.A.R.B. exemption sticker, (attached), must be visible under the hood so that an emissions inspector can see it when the vehicle is required to be tested for emissions. California requires testing every two years, other states may vary.

34. It will be necessary for all K&N® high flow intake systems to be checked periodically for realignment, clearance and tightening of all connections. Failure to follow the above instructions or proper maintenance may void warranty.

ROAD TESTING:

1. Start the engine with the transmission in neutral or park, and the parking brake engaged. Listen for air leaks or odd noises. For air leaks secure hoses and connections. For odd noises, find cause and repair before proceeding. This kit will function identically to the factory system except for being louder and much more responsive.

2. Test drive the vehicle. Listen for odd noises or rattles and fix as necessary.

3. If road test is fine, you can now enjoy the added power and performance from your kit.

4. K&N Engineering, Inc., suggests checking the air filter element periodically for excessive dirt build-up. When the element becomes covered in dirt (or once a year), service it according to the instructions on the Recharger® service kit, part number 99-5050 or 99-5000.

INTAKE SYSTEMS FOR VEHICLES LISTED ARE 50 STATE LEGAL. SEE KNFILTERS.COM FOR CARB STATUS ON EACH PART FOR A SPECIFIC VEHICLE.