



NOT LEGAL FOR SALE OR USE ON ANY POLLUTION CONTROLLED MOTOR VEHICLE IN CALIFORNIA OR STATES ADOPTING CALIFORNIA EMISSION PROCEDURES.

See knfilters.com for CARB status on each part for a specific vehicle

## INSTALLATION INSTRUCTIONS

### 77-1560KTK DODGE / JEEP 2011-14 Durango 2011-15 Grand Cherokee V6-3.6L

**NOTE:** This kit was not designed to fit vehicles with a body lift.

#### TOOLS NEEDED:

Flat Blade Screwdriver  
Ratchet  
Extension  
10mm Socket  
4mm Allen Wrench  
Pliers  
Knife

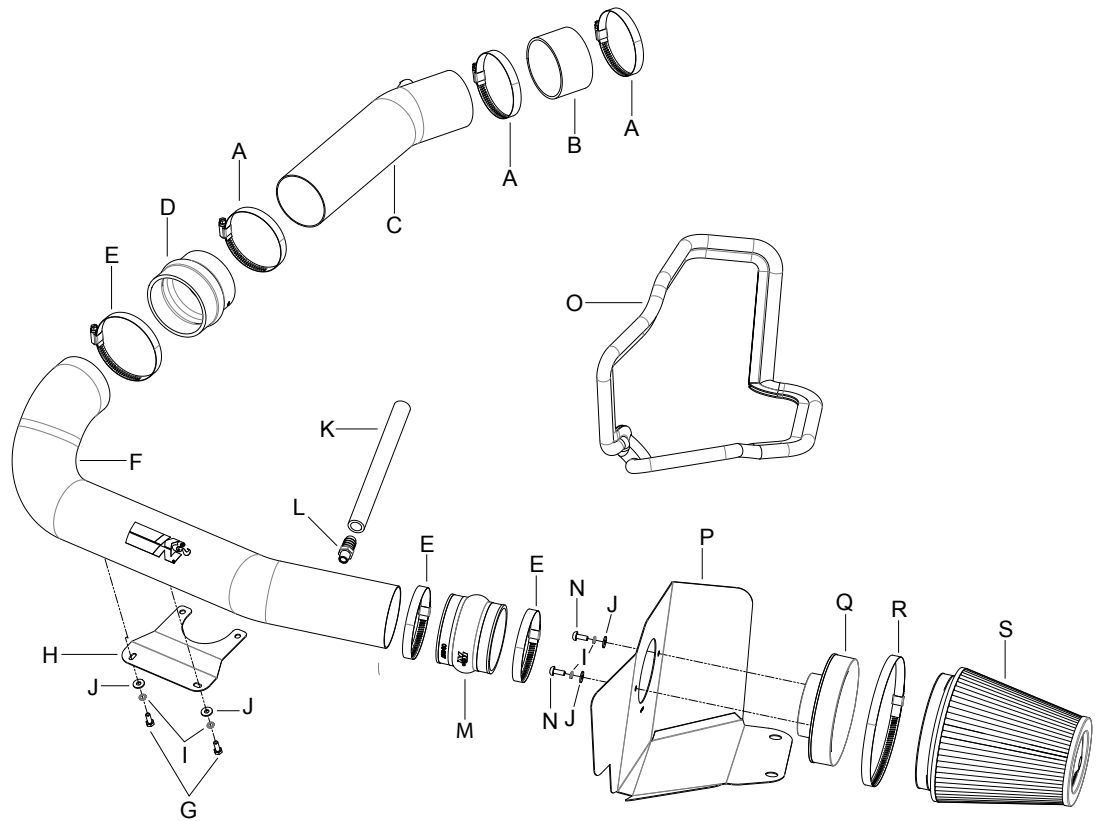

#### PARTS LIST:

Description	Qty.	Part #	Description	Qty.	Part #	Description	Qty.	Part #
A Hose Clamp #52	3	08610	H Bracket; Flat, STL, TB/PC	1	083150	O Edge Trim	1	102480
B Hose; 3-1/4" ID X 2"L Reinforced	1	08690	I Washer, M6 Split Lock Zinc	4	1-3025	P Heat Shield	1	074087
C Intake Tube (A)	1	27446-1	J Washer, 6mm Flat, SS	4	08269	Q Adapter; Universal, 6" Filter 3.5"	1	21512-1
D Hose; Hump 3.25/3.50 X 3.00"	1	5-576	K Hose; 5/8" ID X 9-3/4" L	1	084047	R Hose Clamp #104	1	08697
E Hose Clamp #56	3	08620	L Vent; STRT, 5/8 Barbed 1/4 NPT	1	08911	S Air Filter	1	RF-1041
F Intake Tube (B)	1	27447	M Hose; 3-1/2" ID X 3"L Hump Molded	1	084057			
G Bolt, 6mm-1.00 X 16mm, SS	2	07812	N Bolt; M6 X 1.00 X 16mm, BtnHd. SS	2	07730			

**NOTE: FAILURE TO FOLLOW INSTALLATION INSTRUCTIONS AND NOT USING THE PROVIDED HARDWARE MAY DAMAGE THE INTAKE TUBE, THROTTLE BODY AND ENGINE.**

#### TO START:

1. Turn off the ignition and disconnect the negative battery cable.

**NOTE:** Disconnecting the negative battery cable erases pre-programmed electronic memories. Write down all memory settings before disconnecting the negative battery cable. Some radios will require an anti-theft code to be entered after the battery is reconnected. The anti-theft code is typically supplied with your owner's manual. In the event your vehicles' anti-theft code cannot be recovered, contact an authorized dealership to obtain your vehicles anti-theft code.



2. Lift up the engine cover to unhook it from the mounting grommets and then remove the engine cover from the engine.

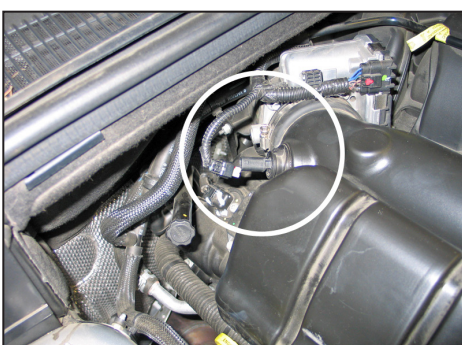

3. Disconnect the inlet air temperature sensor electrical connection.

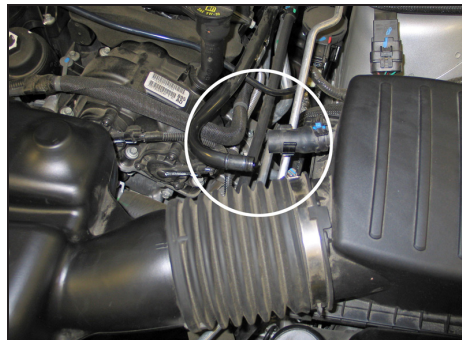

4. Disconnect the crank case vent tube from the air box as shown.



5. Release the two clips that secure the upper air box.



6. Remove the intake tube and upper air box from the vehicle as shown.

**NOTE:** The intake tube is mounted in two locations with grommets.  
**NOTE:** Some models may have an EVAP solenoid that needs to be disconnected.

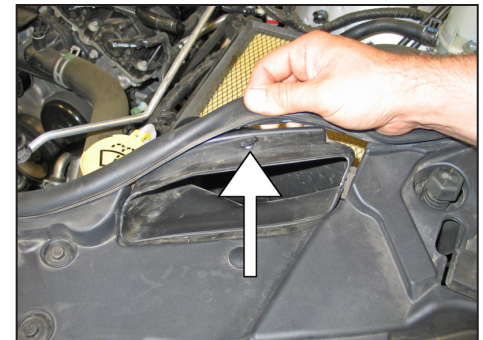

7. Unhook the trim seal from the fresh air intake scoop.



8. Lift up the lower air box to dislodge it from the mounting grommets, then remove the lower air box from the vehicle.

**NOTE:** K&N Engineering, Inc., recommends that customers do not discard factory air intake.

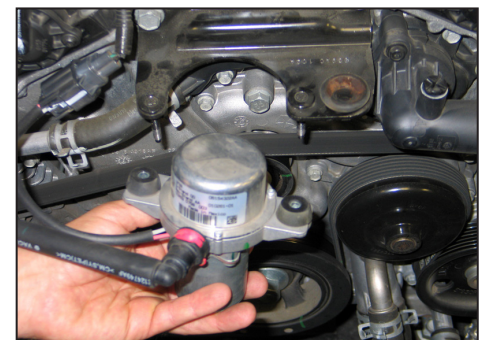

9. Remove the two nuts that secure the air injection pump to the mounting bracket. Gently set the air injection pump aside.

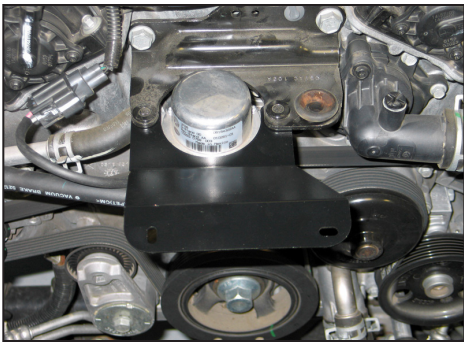

10. Install the provided tube mounting bracket (083150) onto the air injection pump mounting studs, reinstall the air injection pump and secure with the factory mounting nuts from step #9.

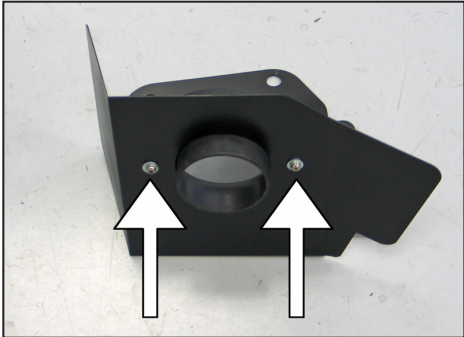

11. Install the filter adapter into the heat shield and secure with the provided hardware.



12. Install the provided edge trim onto the heat shield as shown.

**NOTE: Some trimming of the edge trim will be necessary.**

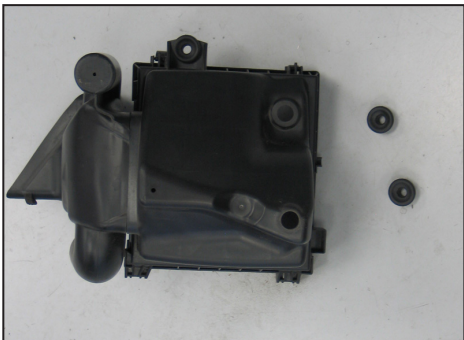

13. Remove two of the air box mounting grommets from the factory air box.

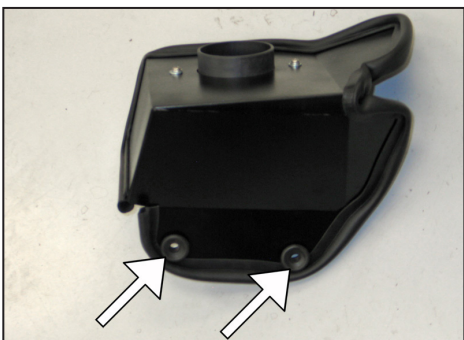

14. Install the two air box mounting grommets into the heat shield as shown.



15. Install the K&N® air filter onto the filter adapter and secure with the provided hose clamp.

**NOTE: Drycharger® air filter wrap; part # RF-1041DK is available to purchase separately. To learn more about Drycharger® filter wraps or look up color availability please visit <http://www.knfilters.com>®.**

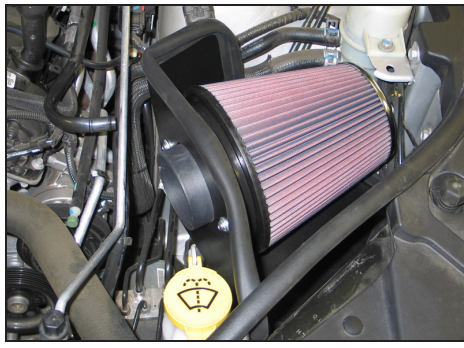

16. Set the heat shield/filter assembly into position so that the mounting grommets slide over the outer air box mounting studs.

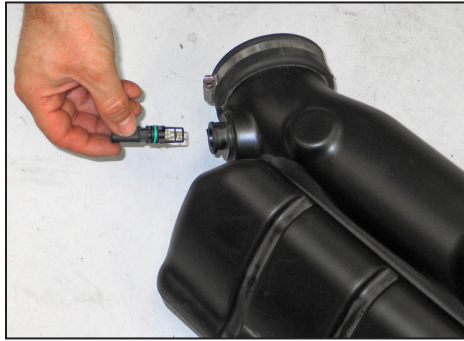

17. Remove the inlet air temperature sensor from the factory intake tube.

**NOTE: The sensor rotates counter clockwise ¼ turn and then pulls out. The inlet air temperature sensor is very fragile.**



18. Install the inlet air temperature sensor into the K&N® intake tube as shown.



19. Install the provided ¼ npt vent fitting into the K&N® intake tube #27447 as shown.

**NOTE: Plastic NPT fittings are easy to cross thread. Install the vent fitting "hand" tight, then turn it two complete turns with a wrench.**

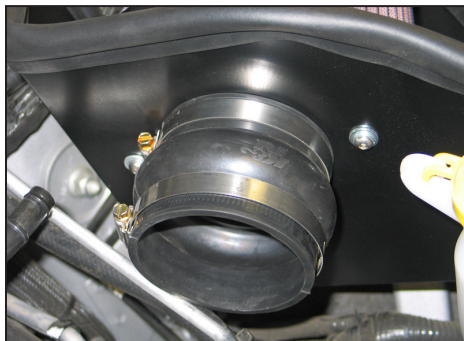

20. Install the provided hump hose (084057) onto to the filter adapter and secure with the provided hose clamp.

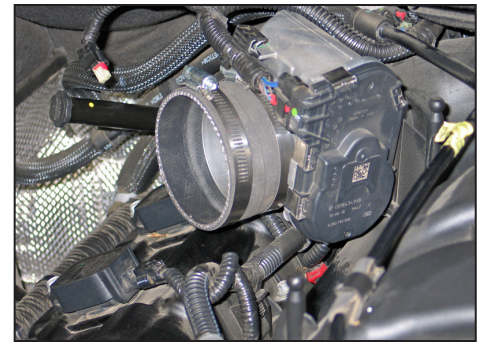

21. Install the provided silicone hose (08690) onto the throttle body and secure with the provided hose clamp.

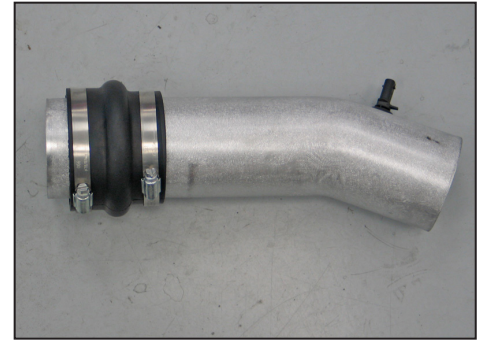

22. Slide the provided silicone hump hose (5-576) all the way onto the K&N® intake tube #27446 as shown.



23. Install the K&N® intake tube #27447 into the silicone hose and onto the mounting bracket so that the tube mounting studs align with the mounting holes in the bracket. Secure the tube with the provided hardware and hose clamp but do not completely tighten at this time. Install the K&N® intake tube #27446 into the throttle body's silicone hose and align the silicone hump hose with the already installed K&N® intake tube. Slide the silicone hose into position between the intake tubes and secure with the provided hose clamps.

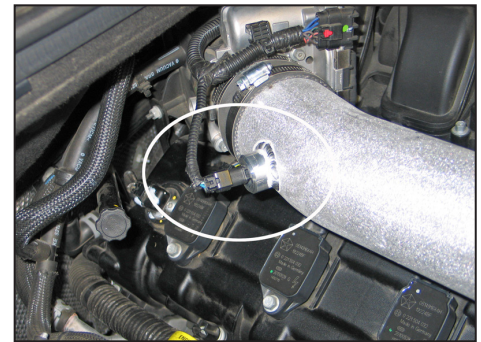

24. Reconnect the inlet air temperature sensor electrical connection.

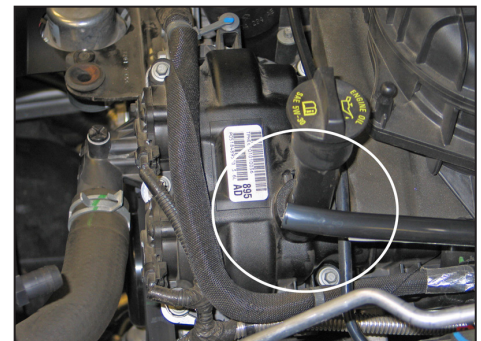

25. Measure the crank case vent tube 5" from the end and then cut off the end with a knife.

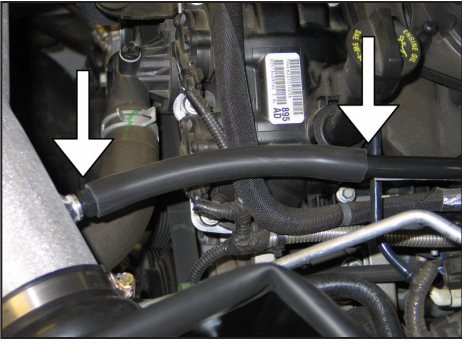

26. Install the provided crank case vent hose onto the vent fitting attached to the K&N® intake tube. Connect the open end of the crank case vent tube to the factory crank case vent tube that was cut in the previous step.



27. Adjust the intake kit for proper fit and then secure the mounting hardware and hose clamps. Reinstall the factory engine cover.



28. Reconnect the vehicle's negative battery cable. Double check to make sure everything is tight and properly positioned before starting the vehicle.

29. It will be necessary for all K&N® high flow intake systems to be checked periodically for realignment, clearance and tightening of all connections. Failure to follow the above instructions or proper maintenance may void warranty.

#### ROAD TESTING:

1. Start the engine with the transmission in neutral or park, and the parking brake engaged. Listen for air leaks or odd noises. For air leaks secure hoses and connections. For odd noises, find cause and repair before proceeding. This kit will function identically to the factory system except for being louder and much more responsive.

2. Test drive the vehicle. Listen for odd noises or rattles and fix as necessary.

3. If road test is fine, you can now enjoy the added power and performance from your kit.

4. K&N Engineering, Inc., requires cleaning the intake system's air filter element every 100,000 miles. When used in dusty or off-road environments, our filters will require cleaning more often. We recommend that you visually inspect your filter once every 25,000 miles to determine if the screen is still visible. When the screen is no longer visible some place on the filter element, it is time to clean it. To clean and re-oil, purchase our filter Recharger® service kit, part number 99-5050 or 99-5000 and follow the easy instructions.

**NOT LEGAL FOR SALE OR USE ON ANY POLLUTION CONTROLLED MOTOR VEHICLE IN CALIFORNIA OR STATES ADOPTING CALIFORNIA EMISSION PROCEDURES.**

See [knfilters.com](http://knfilters.com) for CARB status on each part for a specific vehicle