



# TYPHOON INTAKE SYSTEMS

## INSTALLATION INSTRUCTIONS

### 69-8613

**Scion  
2008 XB  
I4-2.4L**

#### Tools:

- Flat Blade Screw Driver
- Phillips Screw Driver
- Ratchet
- Extension
- 14mm Socket
- 10mm Socket
- 10mm Wrench
- 3mm Allen Wrench
- Pliers

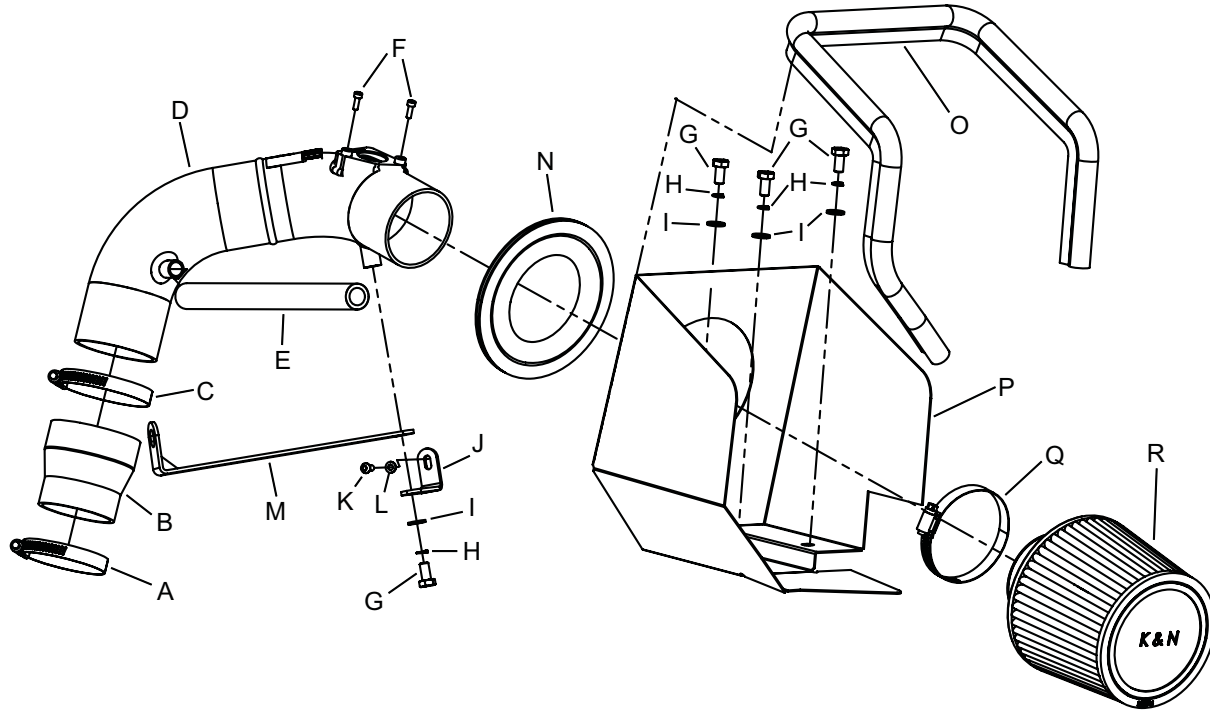

#### Parts List:

Description	Qty.	Part #	Description	Qty.	Part #	Description	Qty.	Part #
A Hose Clamp #40	1	08554	H Washer; 1/4" Lock, ZN	4	08198	O Edge Trim (39")	1	102496
B Hose; 3"ID TO 2-1/2"ID TPRD, SIL	1	08713	I Washer; 1/4"ID X 5/8"OD - SAE	4	08275	P Heat Shield	1	07360
C Hose Clamp #44	1	08577	J Bracket; Small	1	070015	Q Hose Clamp #48	1	08601
D Intake Tube	1	27536	K Bolt; M5 - 0.8 X 12MM B/H, SS	1	07734	R Air Filter	1	RU-3570
E Hose; 5/8"ID X 13"L Silicone	1	08602	L Washer; 5MM Flat, SS	1	08212			
F Bolt; M4 - 0.07 8MM, A/H Cap, SS	2	07733	M Bracket; "L", STL, FB/PC	1	06509			
G Bolt; 6MM-1.00 X 16MM, SS	4	07812	N Edge Trim (17")	1	102469			

**NOTE: FAILURE TO FOLLOW INSTALLATION INSTRUCTIONS AND NOT USING THE PROVIDED HARDWARE MAY DAMAGE THE INTAKE TUBE, THROTTLE BODY AND ENGINE.**

#### TO START:

1. Turn the ignition OFF and disconnect the vehicle's negative battery cable.

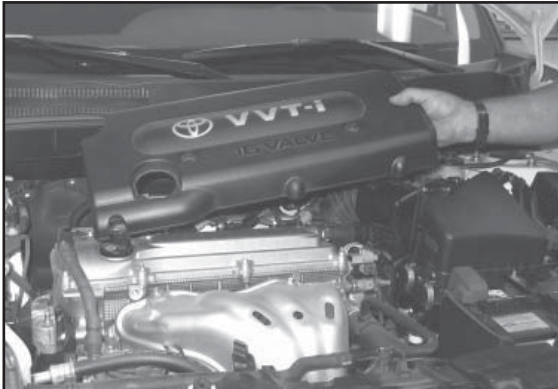

2. Remove the two nuts that secure the engine cover, then remove the engine cover from the engine as shown.

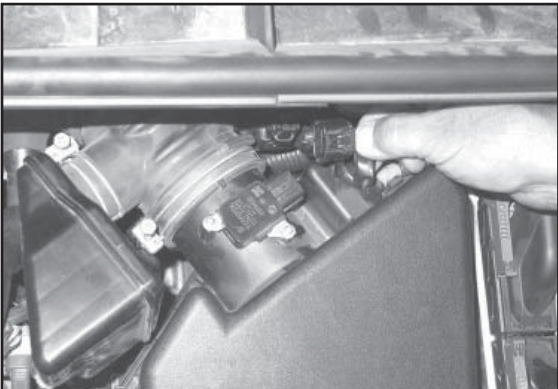

3. Depress the locking tab on the mass air sensor electrical connection, then disconnect the mass air sensor electrical connector.

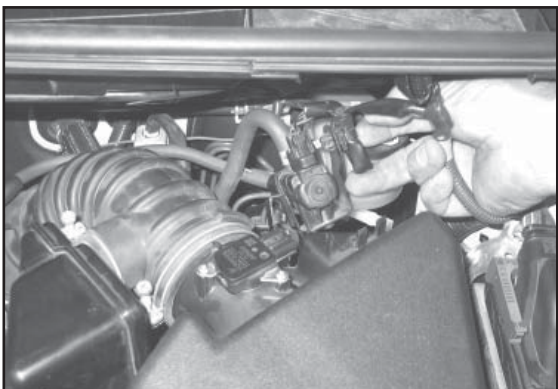

4. Un-hook the EVAP solenoid valve from the stock intake tube as shown.

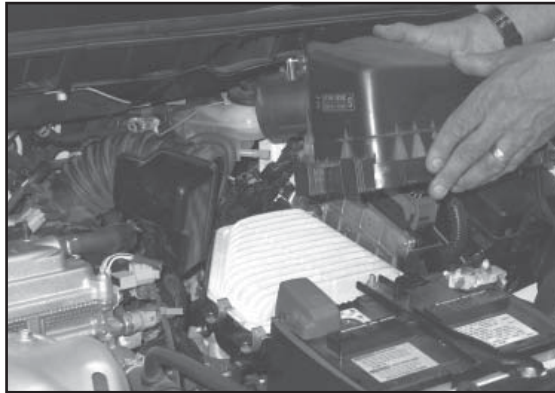

5. Loosen the hose clamp that secures the intake tube to the upper air box. Then, un-hook the three upper air box retaining clips. Remove the upper air box from the vehicle as shown.

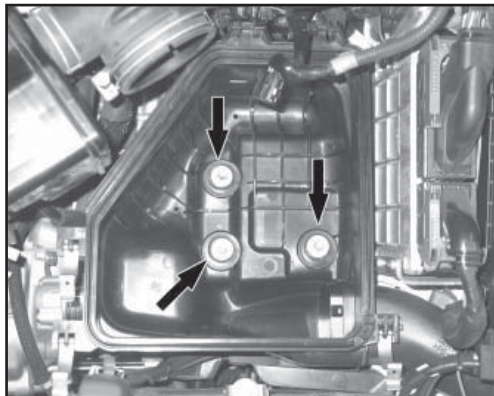

6. Remove the three bolts that secure the lower air box. Then, un-clip the wiring harness and remove the lower air box from the vehicle.



7. Disconnect the crank case vent hose from the valve cover. Loosen the spring clamp that secures the intake tube to the throttle body and remove the stock intake tube from the vehicle.

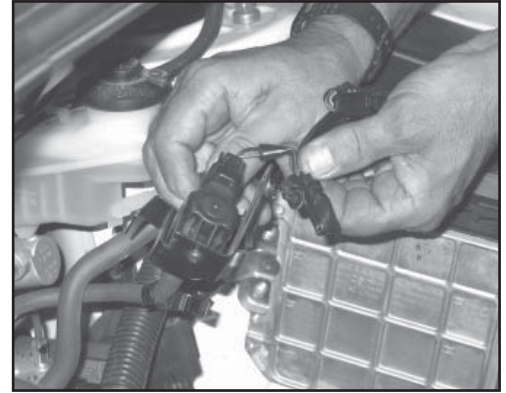

8. Un-hook the EVAP wiring harness from the EVAP mounting bracket as shown.

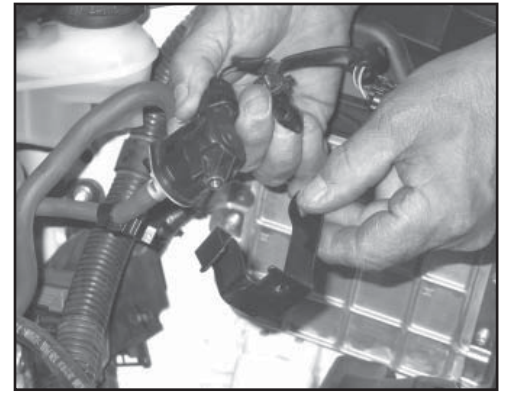

9. Remove the screw that secures the EVAP mounting bracket, then remove the bracket as shown.

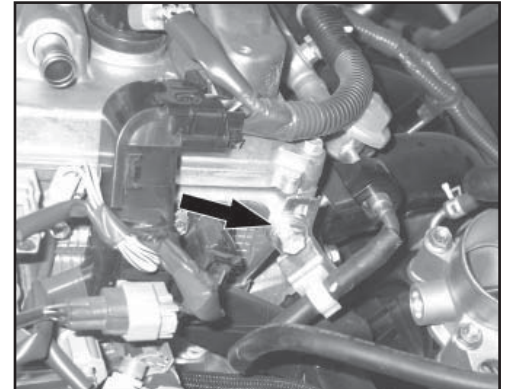

10. Remove the fuel rail mounting bolt shown.

**Note: This bolt will be re-used.**





11. Install the tube mounting bracket (#06509) onto the cylinder head using the bolt removed in the previous step.

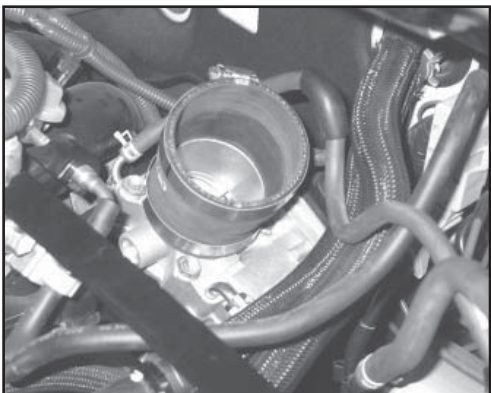

12. Install silicone step hose (#08713) onto the throttle body and secure with the provided hose clamp.



13. Install the provided EVAP bracket onto the EVAP solenoid with the provided hardware.

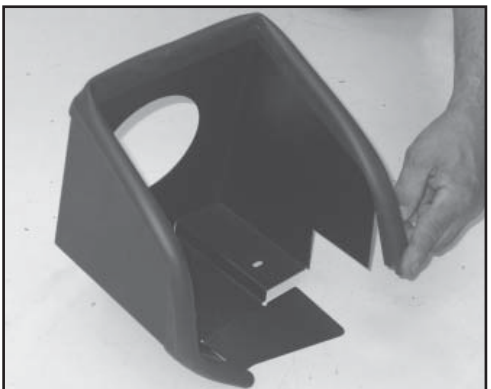

14. Install the long edge trim onto the heat shield as shown.

**Note: Some trimming of the edge trim may be necessary.**



15. Install the short edge trim onto the heat shield as shown.

**Note: Some trimming of the edge trim may be necessary.**

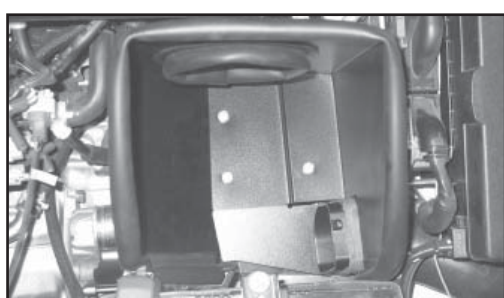

16. Install the heat shield assembly and secure with the provided hardware.

**Note: The fresh air supply tube is to be installed into the heat shield.**



17. Remove the two screws that secure the mass air sensor to the stock air box. Then, remove the mass air sensor as shown.



18. Install the mass air sensor into the K&N intake tube and secure with the provided hardware as shown.

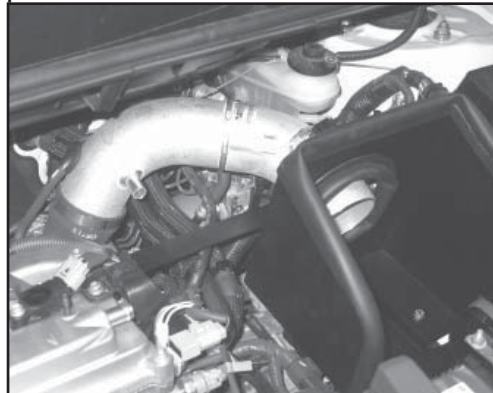

19. Install the K&N intake tube into the silicone hose at the throttle body and align with the mounting bracket. Secure the EVAP bracket and mounting bracket in the same location on the intake tube using the provided hardware.

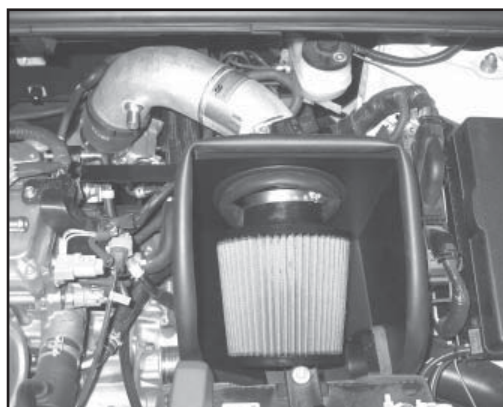

20. Install the K&N air filter and secure with the provided hose clamp.

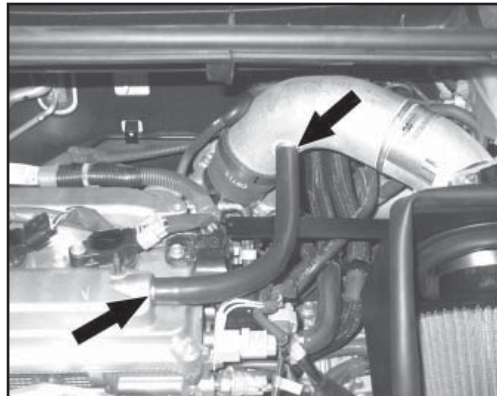

21. Install the provided crank case vent hose as shown.



22. Re-connect the mass air sensor electrical connection.



23. Re-install the engine cover and secure with the factory nuts.

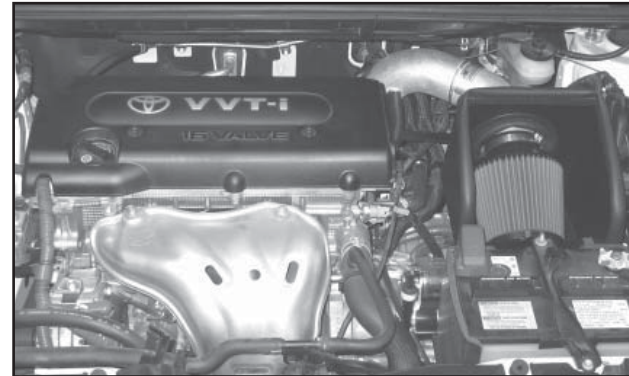

24. Re-connect the vehicle's negative battery cable. Ensure everything is tight and properly positioned before starting the vehicle.

25. The C.A.R.B. exemption sticker, (attached), must be visible under the hood, so that an emissions inspector can see it when the vehicle is required to be tested for emissions. California requires testing every two years, other states may vary.

26. It will be necessary for all Typhoons to be checked periodically for realignment, clearance and tightening of all connections. Failure to follow the above instructions or proper maintenance may void warranty.

#### ROAD TESTING:

1. Start the engine with the transmission in neutral or park, and the parking brake engaged. Listen for air leaks or odd noises. For air leaks secure hoses and connections. For odd noises, find cause and repair before proceeding. This kit will function identically to the factory system except for being louder and much more responsive.

2. Test drive the vehicle. Listen for odd noises or rattles and fix as necessary.

3. If road test is fine, you can now enjoy the added power and performance from your kit.

4. K&N suggests checking the Air Filter element periodically for excessive dirt build-up. When the element becomes covered in dirt (or once a year), service it according to the instructions on the Recharger service kit, part number 99-5000 or 99-5050.