



TYPHOON INTAKE SYSTEMS

INSTALLATION INSTRUCTIONS

69-8610

Toyota
2007-09 Camry
L4-2.4L

Tools:

Flat Blade Screwdriver
Phillips Screwdriver
Ratchet
Extension
10mm Socket
Pliers
10mm Wrench
17mm Wrench
3mm Allen Wrench
4mm Allen Wrench.

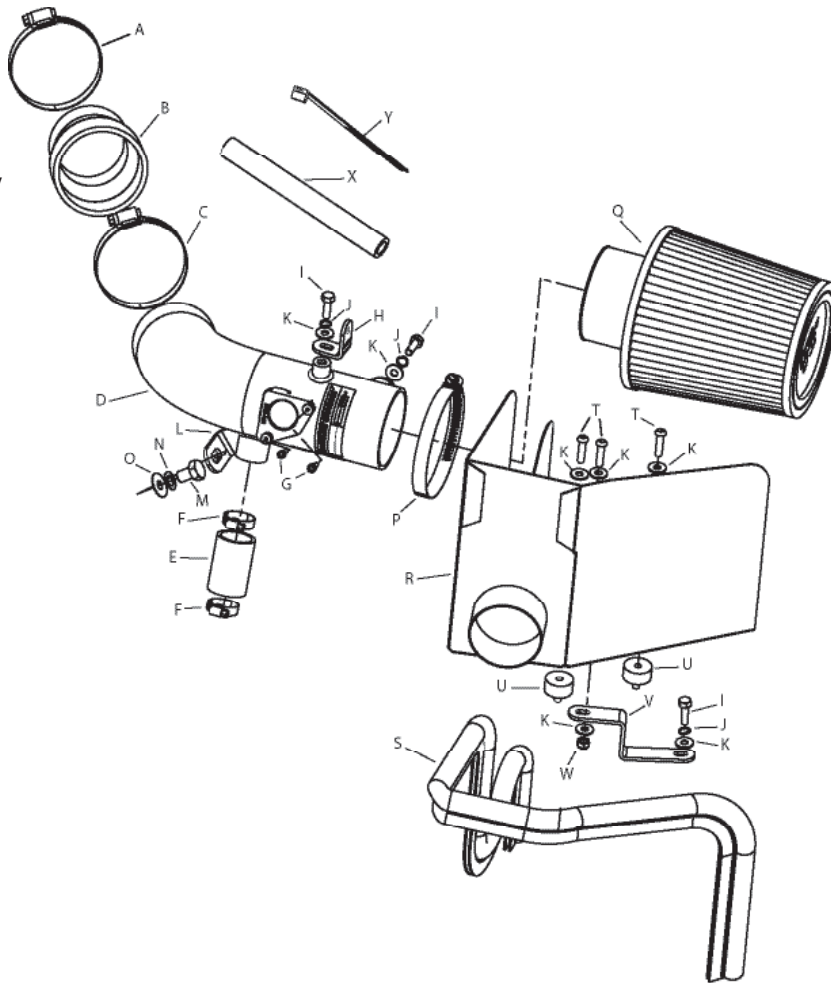

PARTS LIST:

Description	Qty.	Part #
A	Hose Clamp #40	1 08554
B	Hose; 2.5-3.0 Stepped Typhoon	1 08095
C	Hose Clamp #48	1 08601
D	Intake Tube	1 27525
E	Hose; 1-1/8"ID X 2"L, Black Silicone	1 084074
F	Hose Clamp #16	2 08413
G	Bolt; M4 - 0.07 8MM, A/H Cap, SS	2 07733
H	Bracket; "L", SML, STL, FB/PC	1 070066
I	Bolt; M6 X 1.00" X 20MM Hex, SS	3 07795
J	Washer; 1/4" Lock, ZN	3 08198
K	Washer; 6MM Flat, SS	7 08269
L	Bracket; "Z", STL, FB/PC	1 26654
M	Bolt; M10-1.25 X 16MM Hex Head, SS	1 071002
N	Washer; 10MM Wave	1 08175
O	Washer; 3/8" Flat Washer, SS	1 08134
P	Hose Clamp #52	1 08610
Q	Air Filter	1 RU-4990
R	Heat Shield	1 07647
S	Edge Trim	1 102496
T	Bolt; M6 X 1.00 X 16MM, Buttonhead	3 07730
U	Stud; Rbr, M/F, 1/2"L X 1"W, M6 X 1.00	2 02033
V	Bracket; "Z", STL, FB/PC	1 26655
W	Nut; 6MM Nylock, Hexhead	1 07553
X	Hose; 1/2"ID X 7"L, Black Silicone	1 08159
Y	Cable Tie	1 21590

NOTE: FAILURE TO FOLLOW INSTALLATION INSTRUCTIONS AND NOT USING THE PROVIDED HARDWARE MAY DAMAGE THE INTAKE TUBE, THROTTLE BODY AND ENGINE.

TO START:

1. Turn the ignition OFF and disconnect the vehicle's negative battery cable.



2. Disconnect the mass air sensor electrical connection and release the wiring harness from the air box lid.

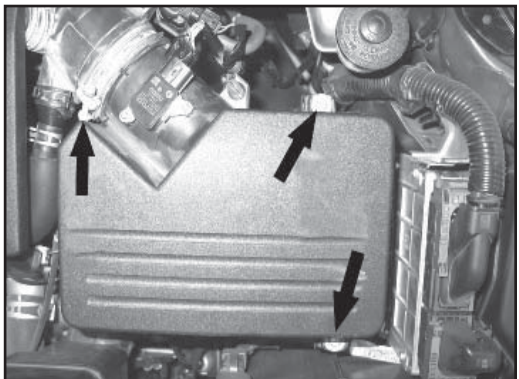

3. Loosen the stock intake tube hose clamp and two upper air box mounting bolts as shown in the photograph.

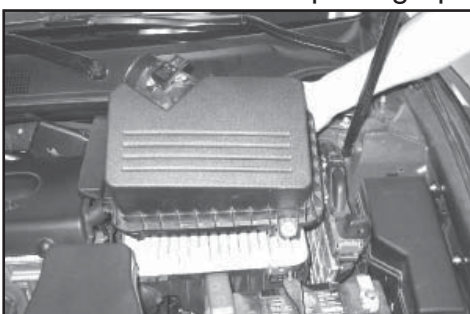

4. Remove the air box lid from the vehicle.

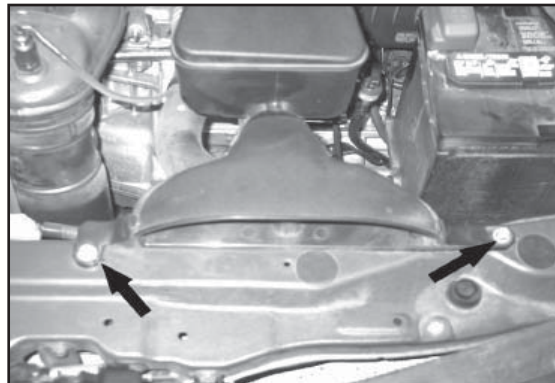

5. Remove the two bolts that secure the fresh air intake to the radiator core support. **Note: These bolts will be re-used, do not discard.**

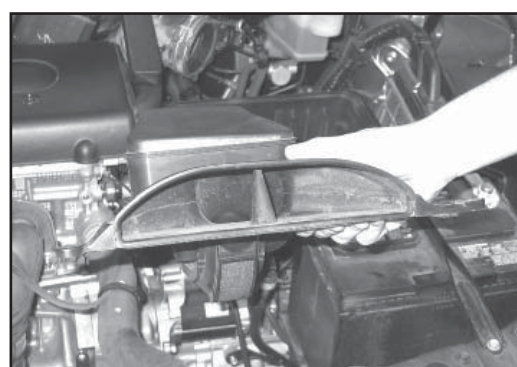

6. Remove the fresh air intake from the lower air box; then, remove from the vehicle.

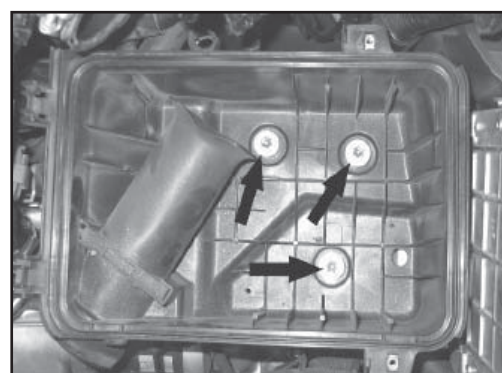

7. Remove the three bolts that secure the lower air box to the mounting bracket.

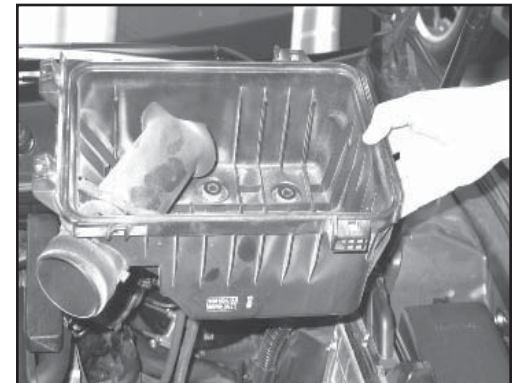

8. Remove the lower air box from the vehicle as shown in the photograph.



9. Remove the two bolts that secure the lower air box mounting bracket to the inner fender and set aside; then, remove the mounting bracket from the vehicle.

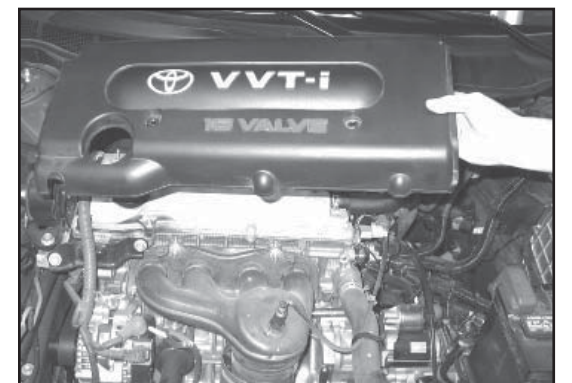

10. Remove the two nuts that secure the engine cover; then, remove the engine cover from the vehicle and set aside. **Note: Engine cover nuts will be re-used, do not discard.**

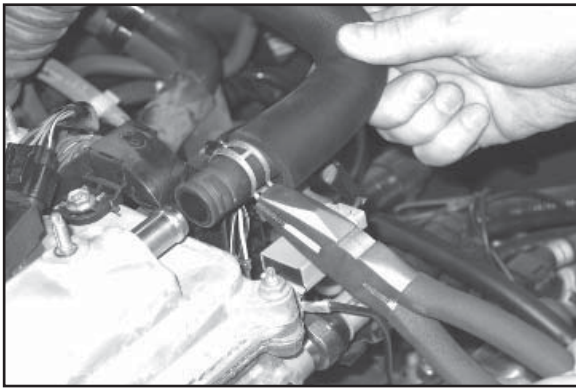

11. Using a pair of pliers, loosen the hose clamp that secures the crank case vent hose to the valve cover; then, disconnect the crank case vent hose from the valve cover.

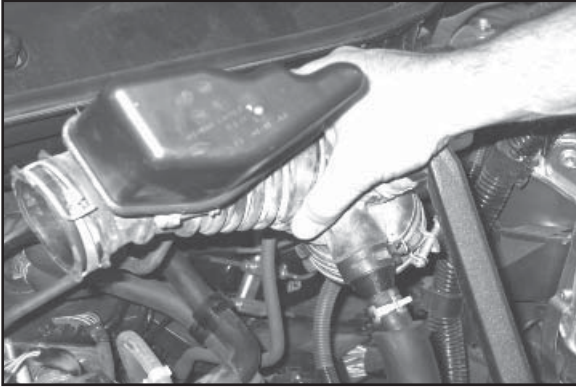

12. Using a pair of pliers, loosen the hose clamp that secure the stock intake tube to the throttle body; then, remove the intake tube from the throttle body as shown in the photograph.

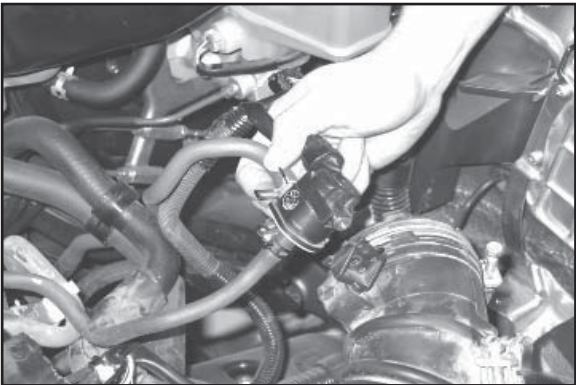

13. Position the intake tube in a fashion that will allow access to the Pulse width modulated (PWM) switching valve mounting screw; then remove the screw. Remove the entire intake tube assembly from the vehicle.

Note: PWM switching valve mounting screw will be re-used, do not discard.

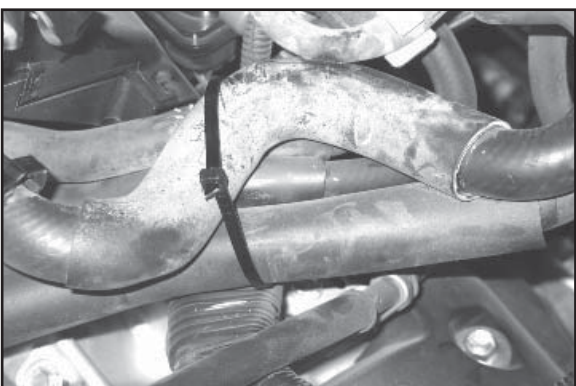

14. Using the provided tie-wrap, secure the heater hoses to the throttle body bypass hoses as shown in the photograph.

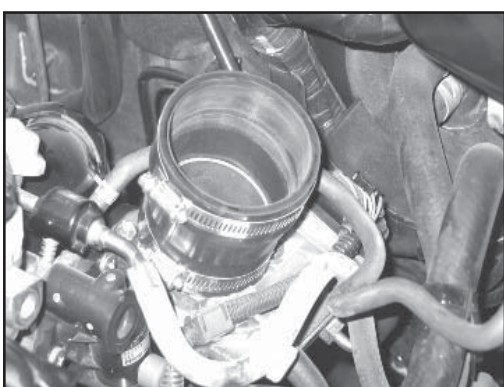

15. Install the provided silicone step hose (08095) onto the throttle body and secure with the provided hose clamp.

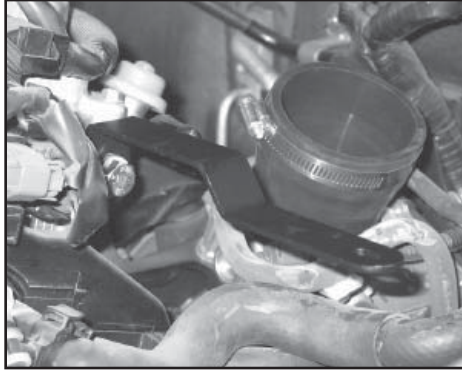

16. Install the intake tube mounting bracket (26654) onto the engine using the provided hardware.

Note: The bracket will fasten to the threaded boss at the rear corner of the cylinder head.

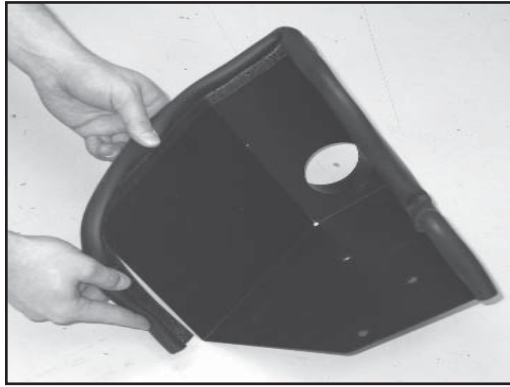

17. Install the provided edge trim onto the heat shield as shown.

Note: Some trimming of the edge trim may be necessary.

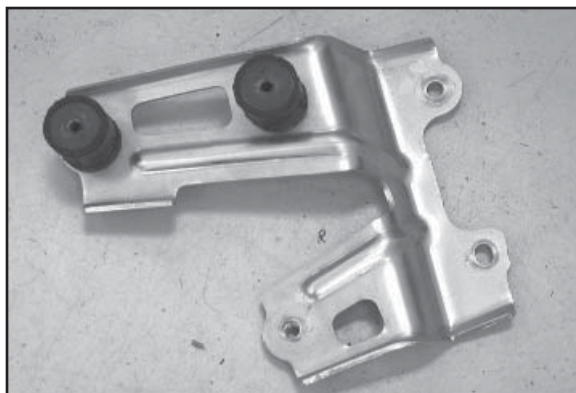

18. Install the two rubber mounted studs onto the air box mounting bracket as shown.

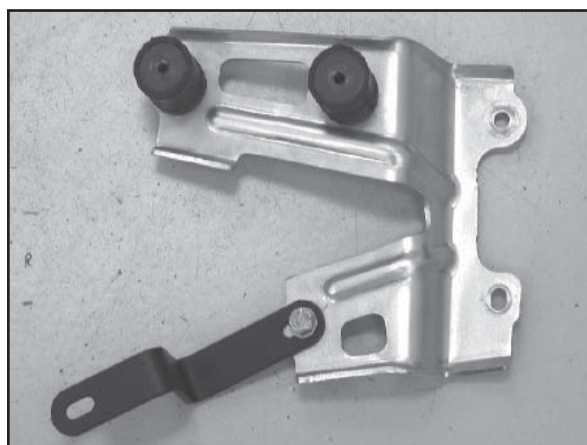

19. Install the supplied "Z" bracket (26655) onto the air box mounting bracket.

Note: Do not completely tighten at this time.

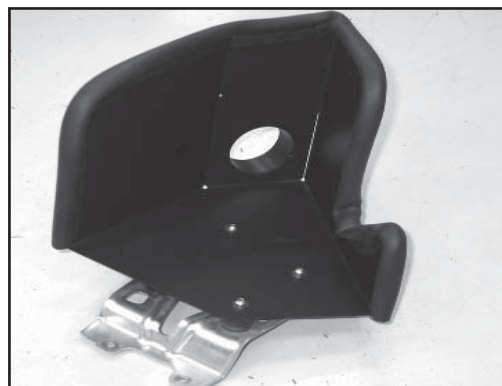

20. Install the air box mounting bracket assembly onto the heat shield and secure with the provided hardware.

Note: do not completely tighten at this time.

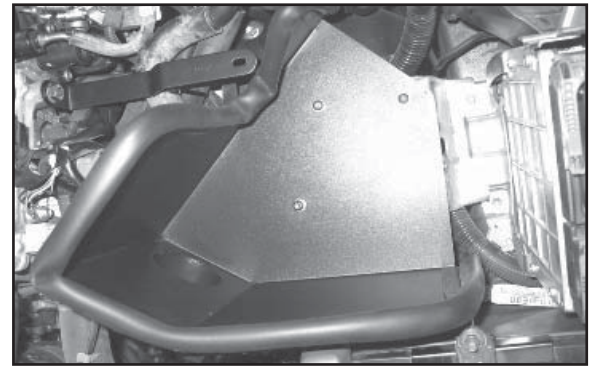

21. Place the heat shield into position and secure the air box mounting bracket to its original location using the two stock bolts removed in step #9.

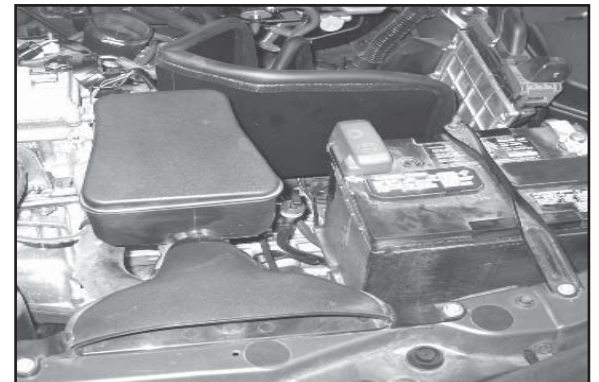

22. Install the fresh air intake onto the provision on the heat shield and adjust for proper fit; then, fasten with the stock bolts removed in step #5.



23. Secure the supplied "L" bracket (070066) to the pulse width modulated (PWM) switching valve using the stock screw removed in step #13.

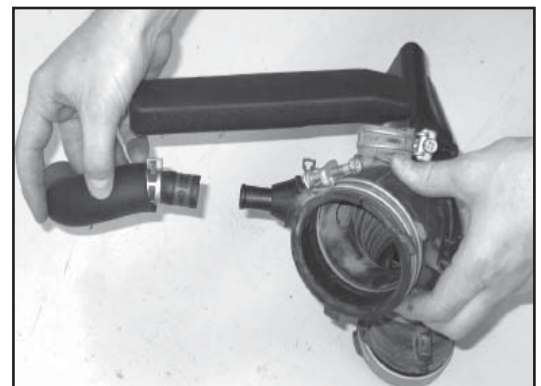

24. Release the hose clamp and remove the crank case vent hose from the crank case vent chamber as shown in the photograph.



25. Release the clamp; then remove the crank case vent hose chamber from the stock intake tube.

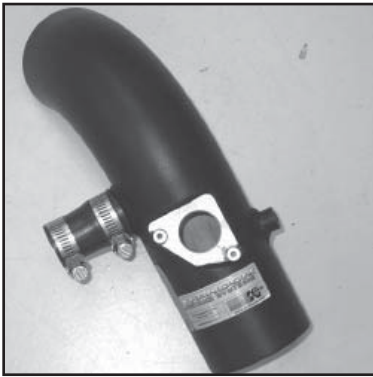

26. Install the provided silicone hose (084074) onto the K&N Intake Tube and secure with the provided hose clamp.



27. Install the stock crank case vent chamber into the silicone hose installed onto the K&N Intake Tube; secure with the provided hose clamp.

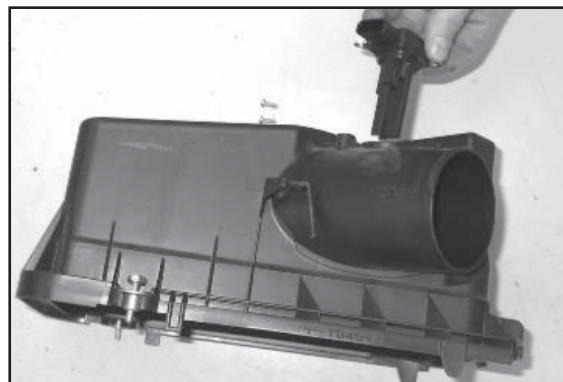

28. Remove the two screws that secure the mass air sensor to the air box. Remove the mass air sensor.



29. Install the stock mass air sensor into the K&N intake tube and secure with the provided hardware.



30. Install the K&N Air Filter onto the K&N Intake Tube; secure using the provided hose clamp.

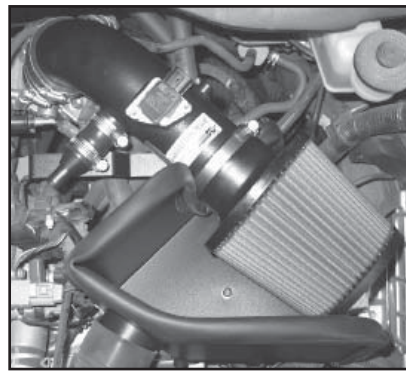

31. Install the K&N Intake Tube assembly into the silicone hose installed onto the throttle body. Align with the intake tube mounting bracket installed in step # 16; then, secure the K&N Intake Tube assembly using the provided hose clamp and hardware.

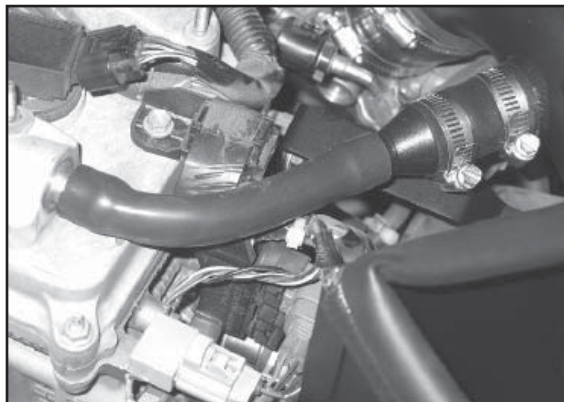

32. Install the provided crank case vent hose onto the crank case vent chamber and valve cover fitting.

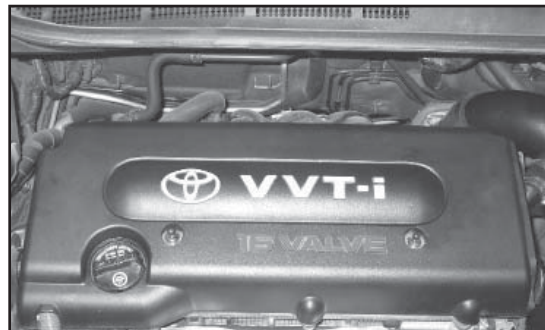

33. Install the stock engine cover and secure with the stock mounting bolts removed in step #10.

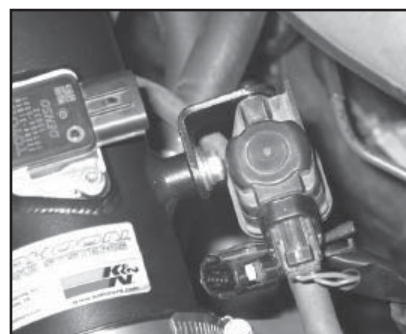

34. Secure the "L" bracket and pulse width modulated (PWM) switching valve assembly to the K&N Intake Tube using the provided hardware.

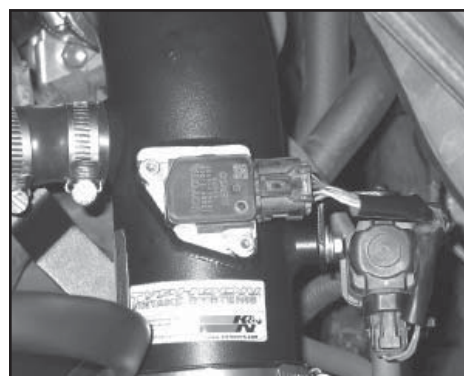

35. Re-connect the mass air sensor electrical connection.



36. Reconnect the vehicle's negative battery cable. Check to ensure all hose clamps and fittings are properly tightened and positioned correctly before starting the vehicle.

37. The C.A.R.B. exemption sticker, (attached), must be visible under the hood, so that an emissions inspector can see it when the vehicle is required to be tested for emissions. California requires testing every two years, other states may vary.

38. It will be necessary for all Typhoons to be checked periodically for realignment, clearance and tightening of all connections. Failure to follow the above instructions or proper maintenance may void warranty.

ROAD TESTING:

1. Start the engine with the transmission in neutral or park, and the parking brake engaged. Listen for air leaks or odd noises. For air leaks secure hoses and connections. For odd noises, find cause and repair before proceeding. This kit will function identically to the factory system except for being louder and much more responsive.

2. Test drive the vehicle. Listen for odd noises or rattles and fix as necessary.

3. If road test is fine, you can now enjoy the added power and performance from your kit.

4. K&N suggests checking the Air Filter element periodically for excessive dirt build-up. When the element becomes covered in dirt (or once a year), service it according to the instructions on the Recharger service kit, part number 99-5000 or 99-5050.