

# TYPHOON INTAKE SYSTEMS

BY 

## INSTALLATION INSTRUCTIONS

### 69-8601

Toyota

2002-06 Matrix XRS

L4-1.8L

Pontiac

2002-06 Vibe GT

L4-1.8L

**NOTE: CARB E.O. #D-269-30 applies to 2003-2004 model years only.**

#### TOOLS NEEDED:

Phillips Screwdriver  
Flat Blade Screwdriver  
Pliers  
Needle nose pliers  
Ratchet  
6" Extension  
14" Extension  
10mm Socket  
3mm Allen Wrench  
4mm Allen Wrench

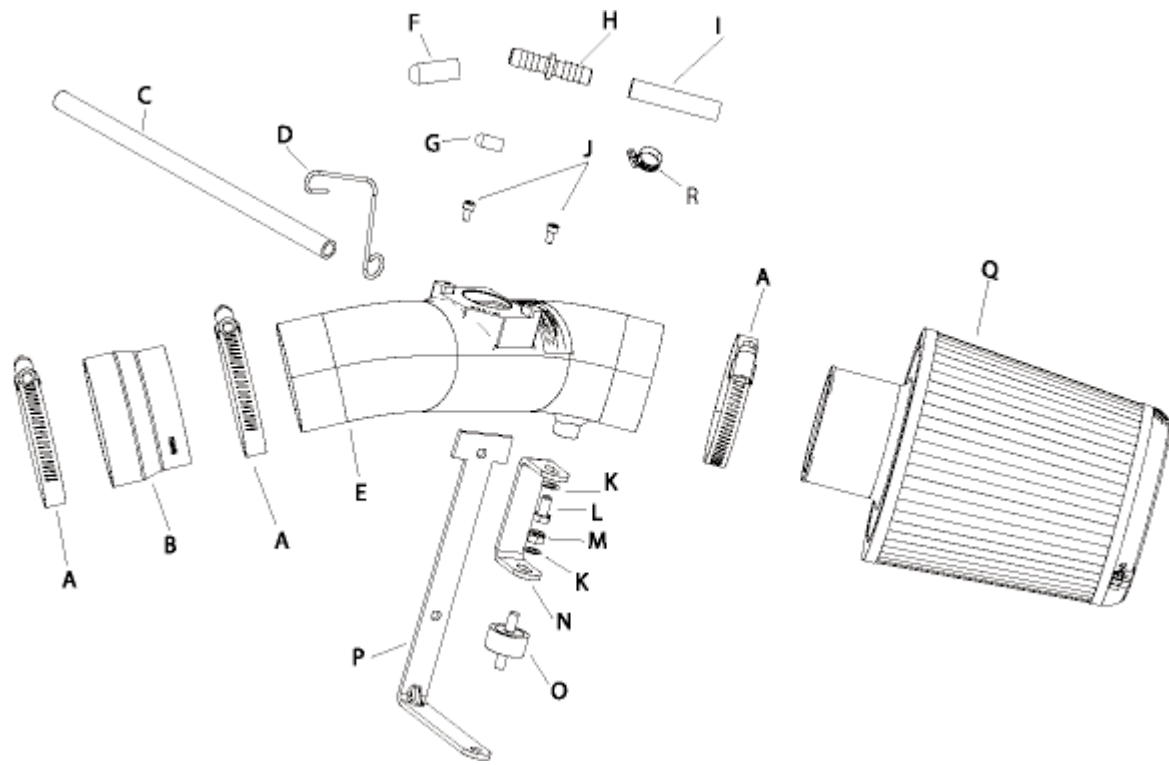

#### PARTS LIST

Desc.	Qty.	Part#	Desc.	Qty.	Part#	Desc.	Qty.	Part#
A Hose Clamp #44	3	08560	F Rubber Cap Plug, Large	1	08214	K 6mm Wave Washer	2	08277
B Silicone Step Hose	1	084036	G Rubber Cap Plus, Small	1	08282	L Hex Bolt, 6mm X 16mm L	1	07812
C Silicone Hose; 8mm X 10"L	1	08156	H Hose Mender, 1/4"-1/4"	1	08041	M 6mm Nylock Nut	1	07512
D Wire Hanger	1	21902	I Silicone Hose, 8mm X 2-1/4"L	1	08062	N "C" Bracket	1	070052
E Typhoon Intake Tube	1	27111	J Cap Screw, 4mm X 8mm L	2	07733	O 6mm Rubber Mounted Stud	1	07027
						P "L" Bracket	1	020009
						Q Filtercharger	1	RU-4960
						R Hose Clamp #6	1	08407

**NOTE: FAILURE TO FOLLOW INSTALLATION INSTRUCTIONS AND NOT USING THE PROVIDED HARDWARE MAY DAMAGE THE INTAKE TUBE, THROTTLE BODY AND ENGINE.**

#### TO START:

1. Turn the ignition OFF and disconnect the vehicle's negative battery cable.



2. Disconnect the mass air sensor electrical connection as shown.



3. Remove the two screws that secure the vacuum switching valve to the air cleaner assembly as shown.



4. Remove the stock bracket from the vacuum switching valve as shown.



5. Unclip the vacuum switching valve hose from the intake tube.



6. Remove screw from PWM switching valve.



7. Loosen the hose clamps at the throttle body and at the air cleaner assembly, then, remove the stock intake tube as shown.

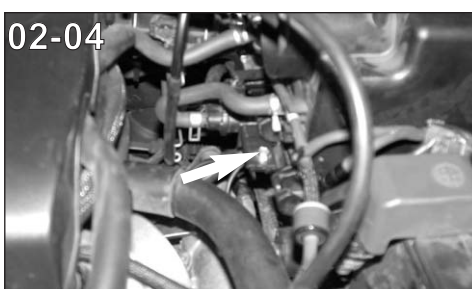

8. Remove the EVAP OBD canister closed valve vent from the air cleaner assembly as shown.

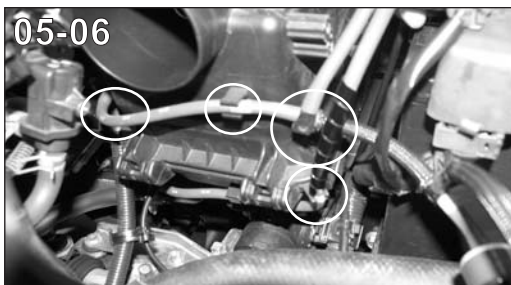

9. Unclip vacuum switching valve hoses from air box, then unclip the PWM switching valve wire harness from upper air box assembly.

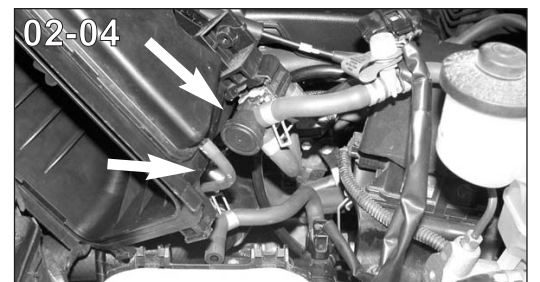

10. Unclip the upper air cleaner assembly, then, tilt upwards to unclip the PWM vacuum switching valve and the vacuum hose as shown.



11. Remove the upper air cleaner assembly as shown.



12. Loosen and remove the bolt that secures the EVAP OBD canister closed valve to the lower air cleaner assembly as shown.

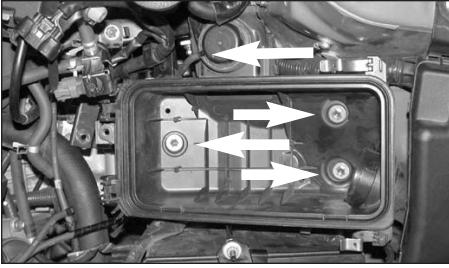

13. Loosen and remove the three bolts that secure the lower air cleaner assembly as shown. Also disconnect the vacuum hose from the butterfly valve as pictured.

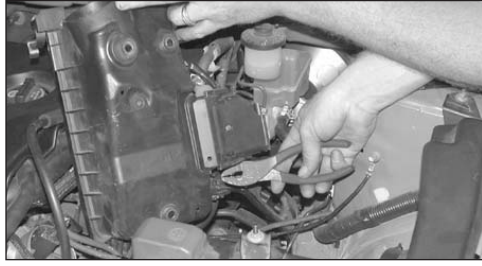

14. Tilt the lower air cleaner assembly upwards to unclip the wire harness as shown.

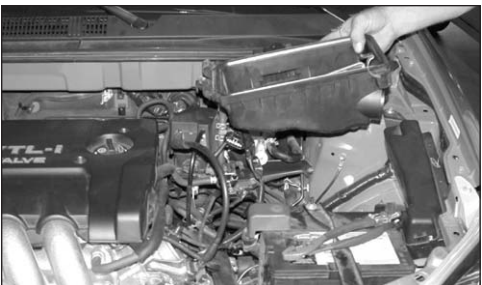

15. Remove the lower air cleaner assembly as shown.

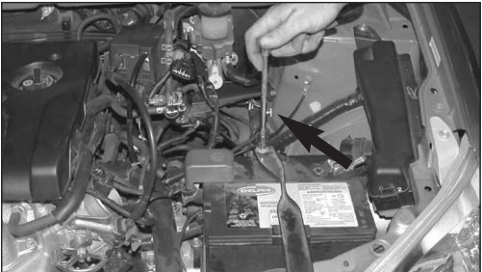

16. Loosen the battery hold down bracket as shown.

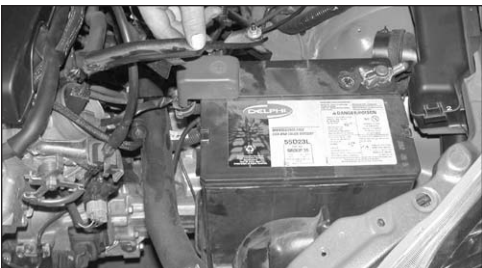

17. Remove the bolt that secures the battery hold down bracket to the radiator core support, then, remove the battery hold down bracket as shown.



18. Remove the push clip that secures the air inlet duct to the radiator core support as shown.



19. Loosen and remove the bolt that secures the air inlet duct to the inner fender as shown.

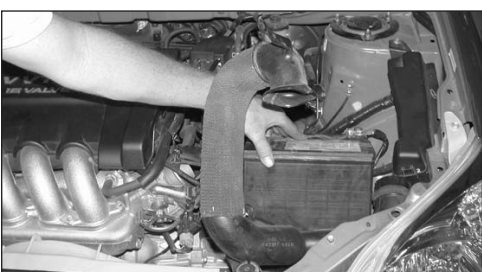

20. Tilt that battery backwards, then, remove the air inlet duct as shown.



21. Reinstall the battery hold down bracket as shown.



22. Disconnect the two vacuum hoses from the vacuum switching valve as shown.

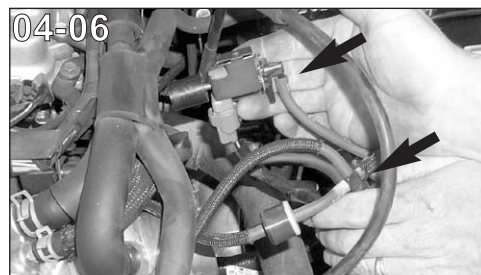
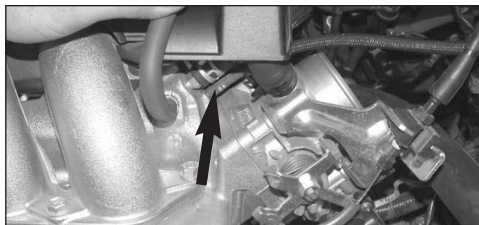

23. Remove the vacuum hose from the intake manifold as shown. On '04-06 models, remove vacuum hose from the vacuum switching valve and the "T" fitting as shown.



24. Install the rubber cap plug onto the vent on the manifold as shown. On '04-06 models, install the rubber cap plug onto the "T" fitting as shown.

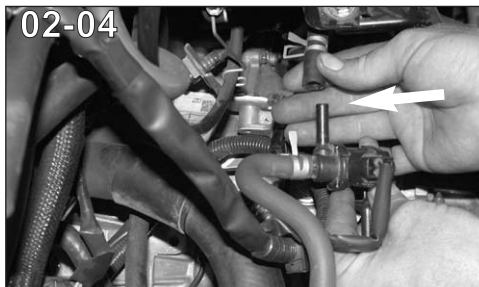

25. Pull the hose clamp back and disconnect the hose from the EVAP OBD canister closed valve as shown.

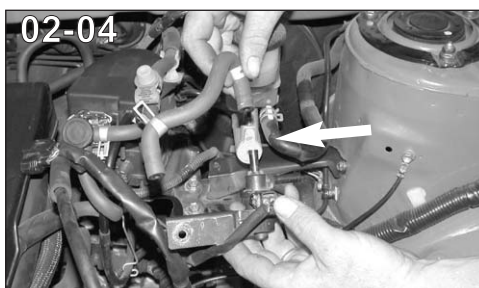

26. Remove the stock hose from the EVAP OBD canister closed valve as shown.



27. Insert the provided hose mender into the stock hose from step 22, then, slide the provided silicone hose onto the end of the hose mender as shown.



28. Slide the EVAP OBD canister closed valve into the hose from step 24.

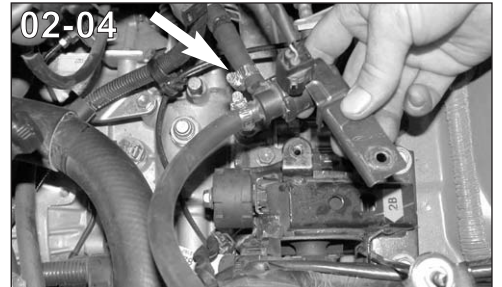

30. Secure the provided "L" bracket and the stock EVAP OBD canister closed valve bracket to the original air cleaner mount, using the provided rubber mounted stud.



31. Secure the provided "L" bracket to the original air cleaner mount using the provided rubber mounted stud.



32. Secure the vacuum switching valve to the "L" bracket using the screw removed in step 4.



33. Install the "C" bracket to the rubber mounted stud using the provided hardware, but do not tighten completely.



34. Secure the PWM switching valve to the "L" bracket. Use screw removed in step #5.



35. Install the mass air sensor into the adapter on the Typhoon intake tube and secure with the provided hardware. Then install the silicone hose and hose clamps.

**NOTE: On 05-06 models, attach vent cap to vent tube onto the Typhoon intake tube as shown.**



36. Slide the tube onto the throttle body but do not tighten completely at this time.



37. Secure the "C" bracket to the threaded boss on the intake tube using the provided hardware.



38. Slide the wire hanger onto the vent on the Typhoon intake tube, then, on 02-04 models connect the hose from the EVAP OBD canister closed valve onto the vent as shown.



39. Slide the throttle cable into the wire hanger as shown.

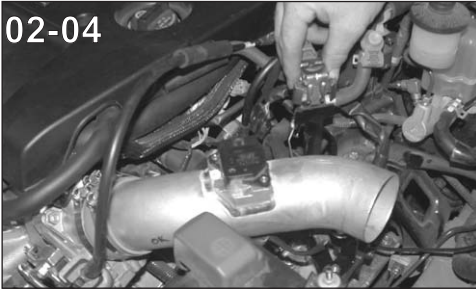

40. Slide the PWM vacuum switching valve onto the "L" bracket as shown.

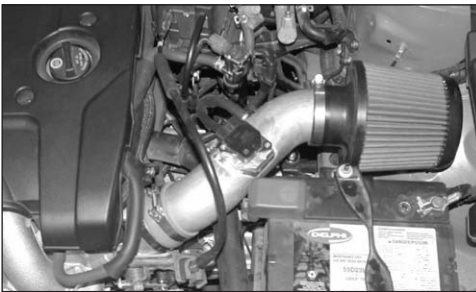

41. Install the K&N air filter onto the Typhoon intake tube and secure with the provided hose clamp as shown.

42. Tighten all hardware and hose clamps and check for clearance.



43. Reconnect the mass air sensor electrical connection as shown.



44. Re-connect the negative battery cable and double check that everything is tight and properly positioned before starting the vehicle.

45. The C.A.R.B. exemption sticker, (attached), must be visible under the hood, so that an emissions inspector can see it when the vehicle is required to be tested for emissions. California requires testing every two years, other states may vary.

46. It will be necessary for all Typhoons to be checked periodically for realignment, clearance and tightening of all connections. Failure to follow the above instructions or proper maintenance may void warranty.

#### ROAD TESTING:

1. Start the engine with the transmission in neutral or park, and the parking brake engaged. Listen for air leaks or odd noises. For air leaks secure hoses and connections. For odd noises, find cause and repair before proceeding. This kit will function identically to the factory system except for being louder and much more responsive.
2. Test drive the vehicle. Listen for odd noises or rattles and fix as necessary.
3. If road test is fine, you can now enjoy the added power and performance from your kit.
4. K&N suggests checking the Air Filter element periodically for excessive dirt build-up. When the element becomes covered in dirt (or once a year), service it according to the instructions on the Recharger service kit, part number 99-5000 or 99-5050.

**\*FREE K&N DECAL To register your warranty, please see us online at [knfilters.com/register](http://knfilters.com/register). FREE K&N DECAL\***