

TYPHOON INTAKE SYSTEMS

BY 

INSTALLATION INSTRUCTIONS

69-8600

Toyota
2002-04 Corolla
2003-04 Matrix XR
L4-1.8L
Pontiac
2003-04 Vibe
L4-1.8L

TOOLS NEEDED:

Pliers
 Flat blade screwdriver
 10mm wrench
 Ratchet
 6" extension
 10mm socket
 4mm allen wrench

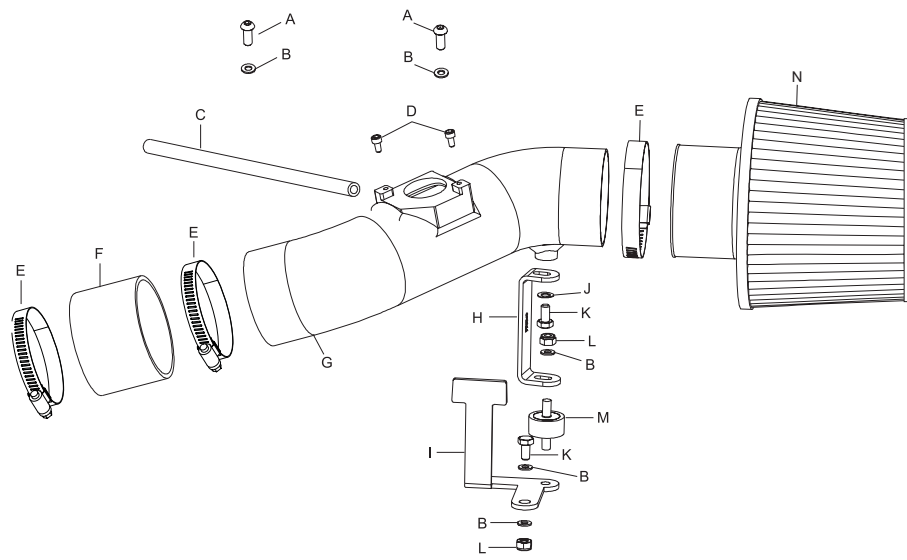

Parts List

Description	Qty.	P/N
A 6mm Button Head Screw, 16mm L.	2	07730
B 6mm Flat Washer	5	08269
C 6mm Silicone Hose, 11" L.	1	084051
D 4mm Cap Screw, 8mm L.	2	07733
E Hose Clamp, #44	3	08560
F Silicone Hose, Black	1	08440
G Typhoon Intake Tube	1	27114
H "C" Bracket	1	070055
I "T" Bracket	1	070054
J 6mm Wave Washer	1	08277
K 6mm Hex Bolt, 16mm L.	2	07812
L 6mm Nylock Nut	2	07512
M 6mm Rubber Mounted Stud	1	07027
N Air Filter	1	RU-4960

THESE INSTRUCTIONS MUST BE FOLLOWED EVERY TIME THE FILTER IS SERVICED, OTHERWISE THE FILTER MAY NOT SEAL, AND DAMAGE TO THE ENGINE COULD RESULT.

TO START:

1. Turn the ignition OFF and disconnect the vehicle's negative battery cable.

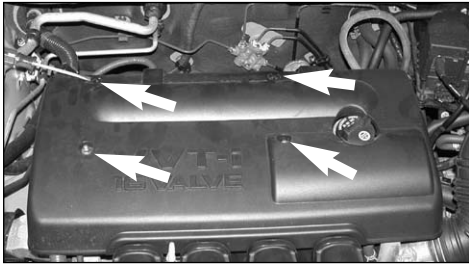

2. Using a flat blade screwdriver remove the two push clips on the engine cover as shown. Also remove the two acorn nuts on the engine cover.



3. Remove the engine cover as shown.

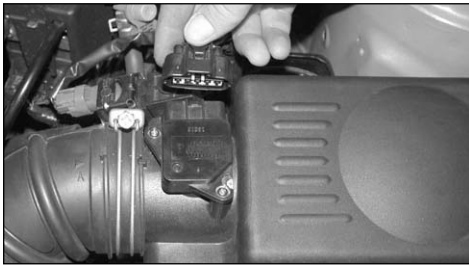

4. Disconnect the mass air sensor electrical connection as shown.

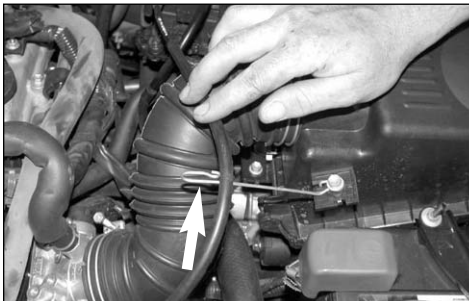

5. Remove the throttle cable from the stock wire hanger as shown.

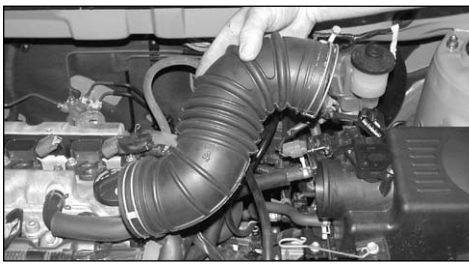

6. Loosen the hose clamps at the throttle body and at the air cleaner, then, remove the stock intake tube as shown.

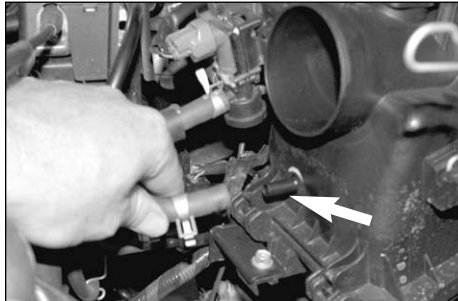

7. Disconnect the EVAP OBD canister closed valve vent hose from the air cleaner assembly as shown.



8. Unclip the upper air cleaner assembly and tilt it upward, then, using a flat blade screwdriver depress the release tab on the air cleaner assembly to release the PWM vacuum switching valve as shown.



9. Remove the upper air cleaner assembly as shown.



10. Remove the three bolts that secure the air cleaner assembly, then tilt the air cleaner assembly upward as shown.

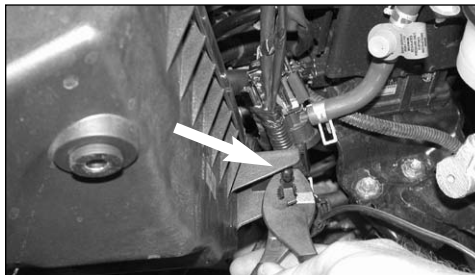

11. Using a pair of pliers unclip the wire harness from the lower air cleaner assembly as shown.

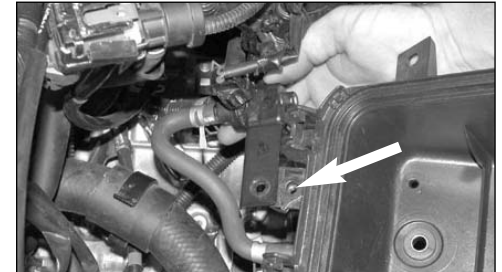

12. Remove the bolt that secures the EVAP OBD canister closed valve to the lower air cleaner assembly as shown.



13. Remove the lower air cleaner assembly as shown.

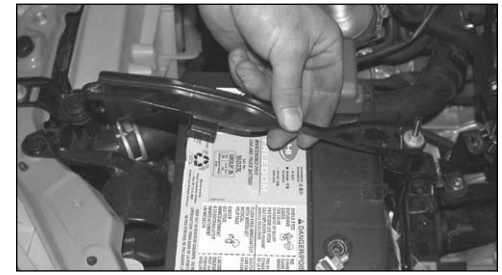

14. Remove the bolt that secures the battery hold down bracket to the radiator core support then move the bracket out of the way as shown.



15. Remove the bolt that secures the air inlet duct to the inner fender as shown.

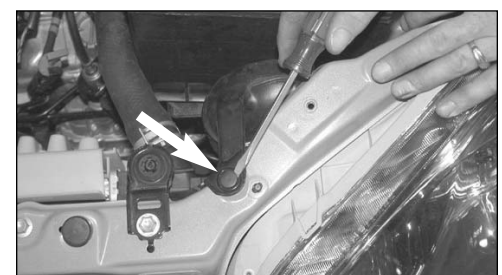

16. Remove the push clip that secures the air inlet duct to the radiator core support as shown.



17. Tilt the battery backward and slide the air inlet duct out of the engine compartment as shown.

18. Reverse the removal process and secure the battery using the stock battery hold down bracket.

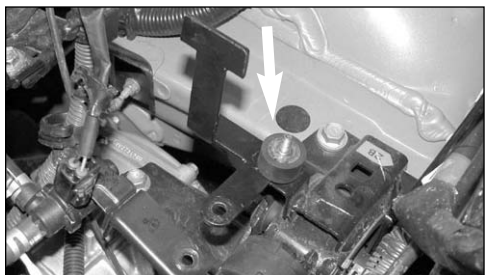

19. Secure the provided T-bracket to the stock air cleaner mount using the provided rubber mounted stud.

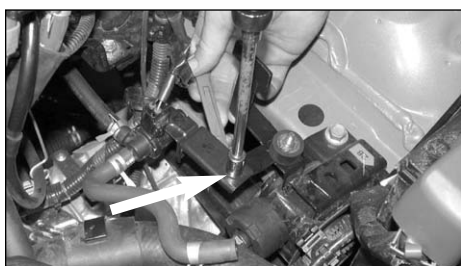

20. Secure the EVAP OBD canister closed valve to the T-bracket from step 19 using the provided hardware.

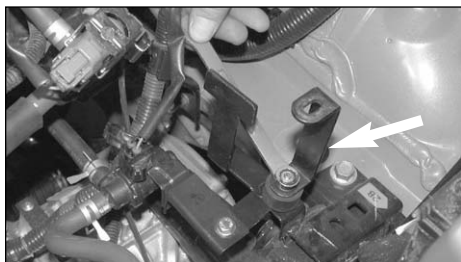

21. Secure the provided "C" bracket to the rubber mounted stud using the provided hardware. Do not tighten as some adjustment will be necessary.



22. Disconnect the vent hose on the PWM vacuum switching valve, then, reroute the hose in front of the cruise control cable and reconnect as shown.



23. Slide the PWM vacuum switching valve onto the T-bracket as shown.

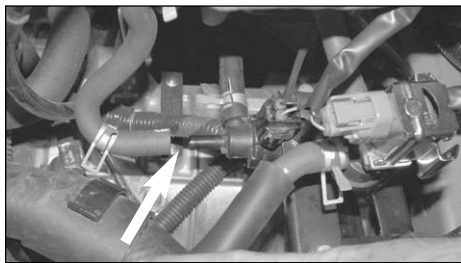

24. Remove the vent hose from the EVAP OBD canister closed valve as shown.



25. Install the provided silicone hose onto the EVAP OBD canister closed valve as shown.



26. Remove the mass air sensor from the upper air cleaner assembly as shown.

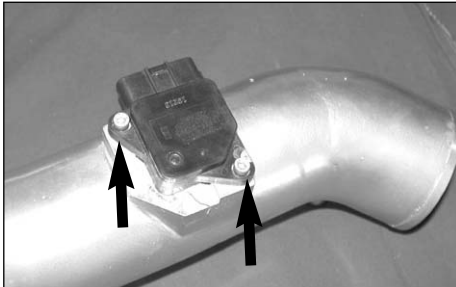

27. Install the mass air sensor into the K&N Typhoon intake tube using the provided hardware as shown.

NOTE: Before installing the mass air sensor, inspect the inside of the tube for any debris, then clean the inside out with water and a towel. Inspect the tube one more time before proceeding to the next step.



28. Install the silicone hose and hose clamps onto the throttle body and secure as shown.



29. Slide the K&N Typhoon intake tube into the silicone hose on the throttle body as shown. Do not tighten completely at this time.



30. Line up the K&N Typhoon intake tube with the "C" bracket and adjust the bracket for best fit, then, secure the tube to the bracket with the provided hardware.

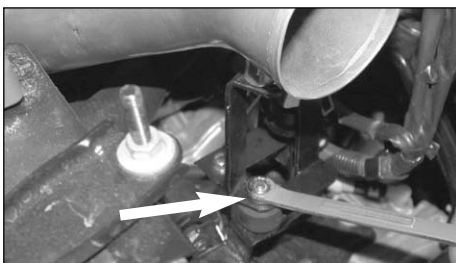

31. Tighten the nylock nut on the "C" bracket and rubber mounted stud as shown.

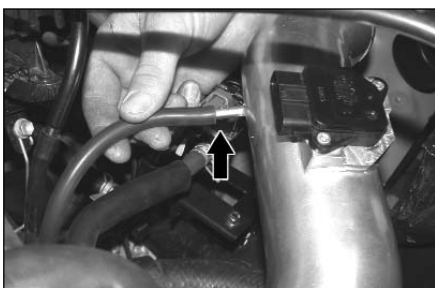

32. Connect the EVAP OBD canister closed valve to the vent on the K&N Typhoon intake tube as shown.

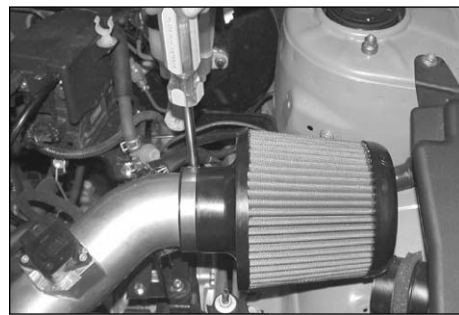

33. Install the K&N X-Stream Filtercharger onto the K&N Typhoon intake tube as shown.



34. Reconnect the mass air sensor electrical connection as shown.



35. Reinstall the stock engine cover using the stock acorn nuts and the provided button head screws to replace the stock push clips.



36. Re-connect the negative battery cable and double check that everything is tight and properly positioned before starting the vehicle.

37. The C.A.R.B. exemption sticker, (attached), must be visible under the hood, so that an emissions inspector can see it when the vehicle is required to be tested for emissions. California requires testing every two years, other states may vary.

38. It will be necessary for all Typhoons to be checked periodically for realignment, clearance and tightening of all connections. Failure to follow the above instructions or proper maintenance may void warranty.

ROAD TESTING:

1. Start the engine with the transmission in neutral or park, and the parking brake engaged. Listen for air leaks or odd noises. For air leaks secure hoses and connections. For odd noises, find cause and repair before proceeding. This kit will function identically to the factory system except for being louder and much more responsive.

2. Test drive the vehicle. Listen for odd noises or rattles and fix as necessary.

3. If road test is fine, you can now enjoy the added power and performance from your kit.

4. K&N suggests checking the Filtercharger element periodically for excessive dirt build-up. When the element becomes covered in dirt (or once a year), service it according to the instructions on the Recharger service kit, part number 99-5000 or 99-5050.