



# TYPHOON INTAKE SYSTEMS

NOT LEGAL FOR SALE OR USE ON ANY POLLUTION CONTROLLED MOTOR VEHICLE IN CALIFORNIA OR STATES ADOPTING CALIFORNIA EMISSION PROCEDURES.  
See knfilters.com for CARB status on each part for a specific vehicle

## INSTALLATION INSTRUCTIONS

**69-3537TS**  
**FORD**  
**2013-15 Escape**  
**L4-1.6L / 2.0L**

**TOOLS NEEDED:**

- ratchet
- extension
- 10mm socket
- 10mm wrench
- flat blade screw driver

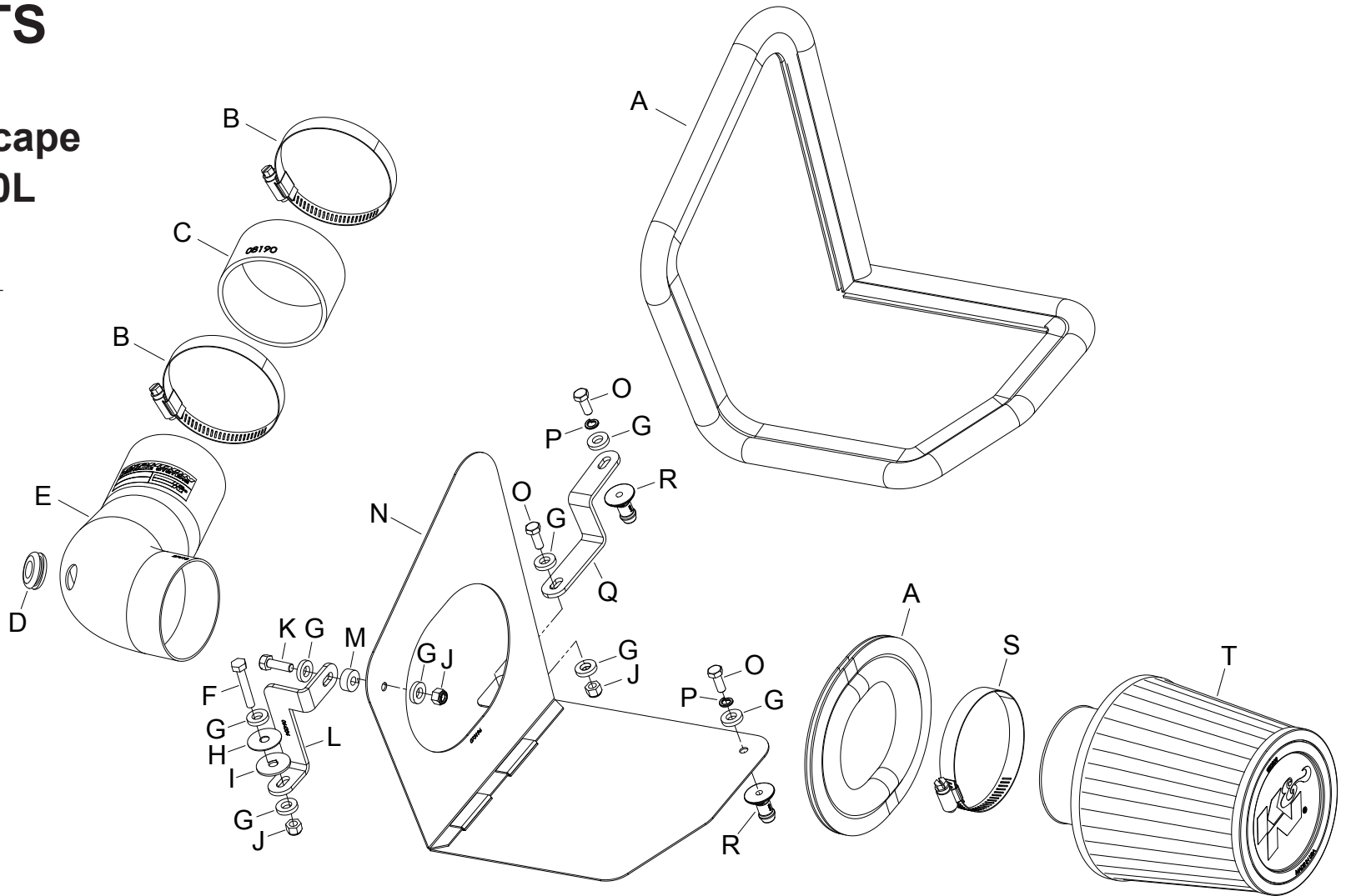

**PARTS LIST:**

Description	Qty.	Part #	Description	Qty.	Part #	Description	Qty.	Part #
A edge trim (61")	1	102492	H washer; 1" d x 1/4 hole fender	1	08160	O bolt; 6mm-1.00 x 16mm, ss	3	07812
B hose clamp #48	2	08601	I washer; 1" x .300 x .100 rubber	1	21685	P washer, m6 split lock zinc	2	1-3025
C hose; 3" id x 1-3/4" l reinforced	1	08190	J nut; 6mm nylock, hexhead	3	07553	Q bracket; "z", 69-8610, stl, tb/pc	1	26655
D grommet; 1-1/16od, 1/2id, 3/8 thk	1	080544	K bolt; m6 x 1.00" x 20mm hex, ss	1	07795	R mount, plastic airbox	2	8-186-1
E intake tube	1	27613TS	L bracket; "z", 69-3537, stl, tb/pc	1	064334	S hose clamp #52	1	08610
F bolt, hex m6-1 x 35mm	1	1-2002	M spacer: .625" od x .250" id x .250" l	1	06555	T air filter	1	RU-4990
G washer; 1/4" id x 5/8" od - sae	8	08275	N heat shield	1	073196			

**NOTE: FAILURE TO FOLLOW INSTALLATION INSTRUCTIONS AND NOT USING THE PROVIDED HARDWARE MAY DAMAGE THE INTAKE TUBE, THROTTLE BODY AND ENGINE.**

**TO START:**

1. Turn off the ignition and disconnect the negative battery cable.  
**NOTE: Disconnecting the negative battery cable erases pre-programmed electronic memories. Write down all memory settings before disconnecting the negative battery cable. Some radios will require an anti-theft code to be entered after the battery is reconnected. The anti-theft code is typically supplied with your owner's manual. In the event your vehicles anti-theft code cannot be recovered, contact an authorized dealership to obtain your vehicles anti-theft code.**



2. Lift up and remove the decorative engine cover.

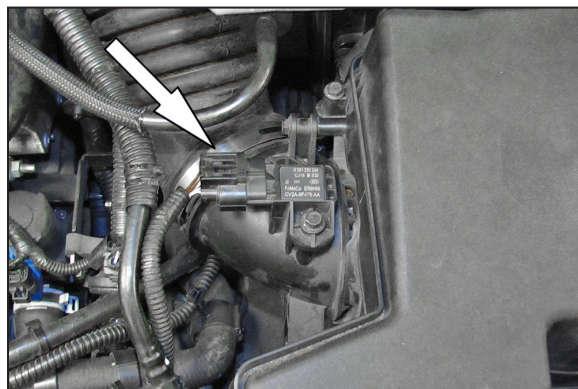

3. Disconnect the inlet air temperature sensor electrical connection.



4. Release the rubber strap that secures the fresh air intake hose.

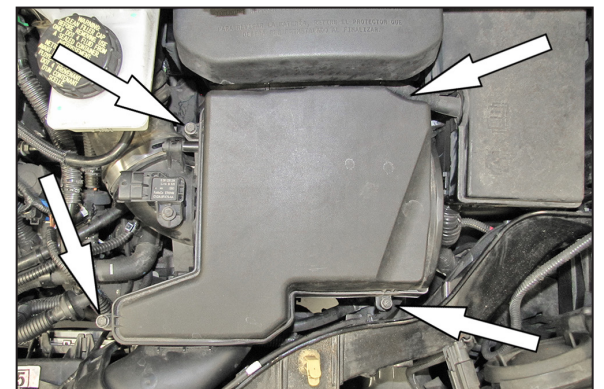

5. Loosen the four screws that secure the air filter housing lid and then remove the lid and factory air filter.

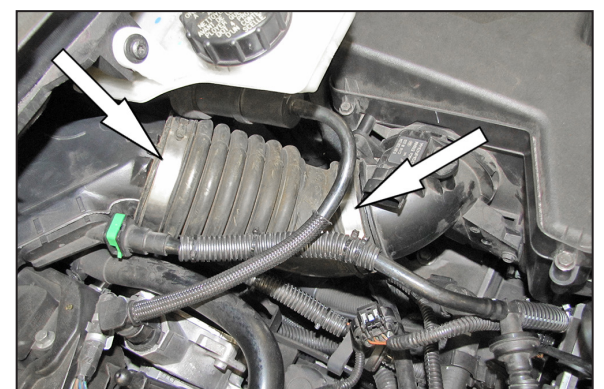

6. Loosen the two hose clamps that secure the factory intake hose.



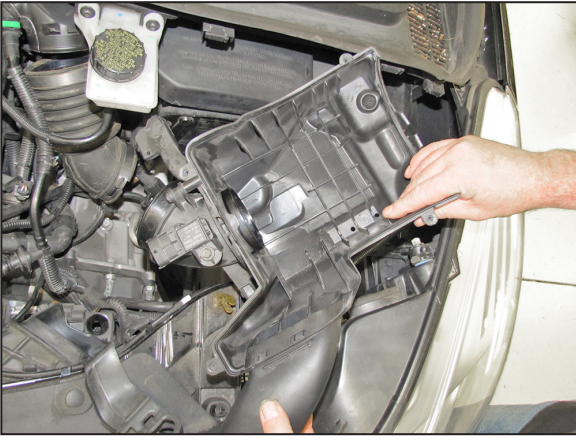

7. Lift up the lower air filter housing to dislodge it from the mounting grommets then rotate the housing up and remove it from the vehicle. Remove the factory intake tube at this time. **NOTE: K&N Engineering, Inc., recommends that customers do not discard factory air intake.**

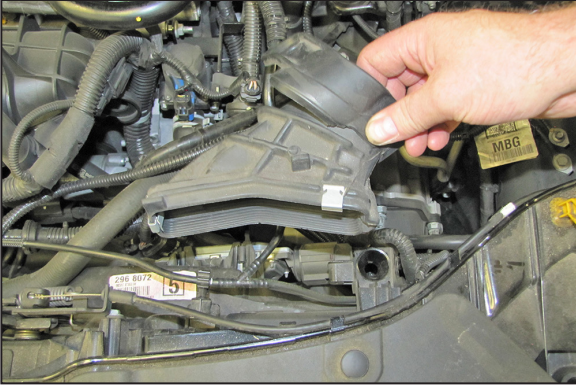

8. Remove the rubber fresh air intake duct.



9. Install the provided coupler (08190) onto the turbo inlet tube and secure with the provided hose clamp.



10. Install the provided mounting stud onto the heat shield mounting bracket (26655) as shown.



11. Install the mounting bracket assembly onto the heat shield as shown.

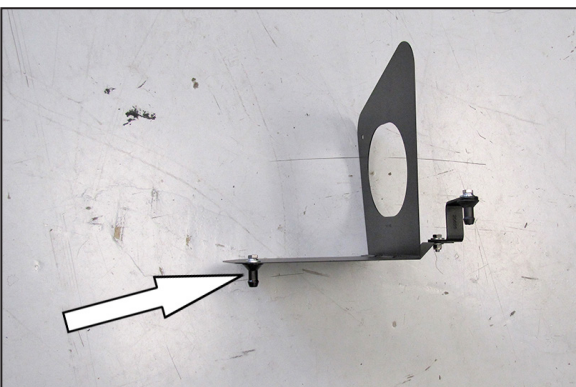

12. Install the remaining mounting stud onto the heat shield as shown using the provided hardware.

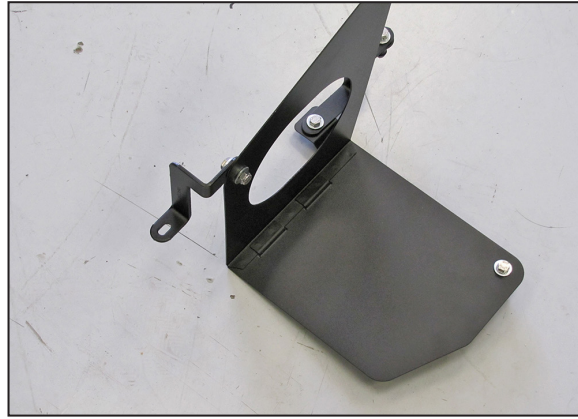

13. Install the provided bracket (064334) onto the heat shield as shown.

**NOTE: Be sure to place the provided spacer between the heat shield and bracket. Do not completely tighten the mounting bolt at this time.**

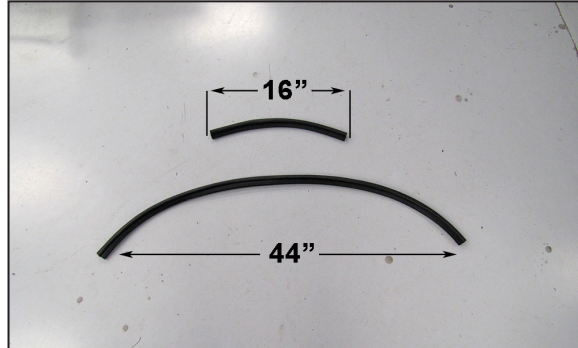

14. Cut the provided edge trim into two sections, one section will be 16" long and the other section will be 44" long.



15. Install the 16" edge trim into the hole of the heat shield and install the 44" edge trim around the outside of the heat shield as shown.

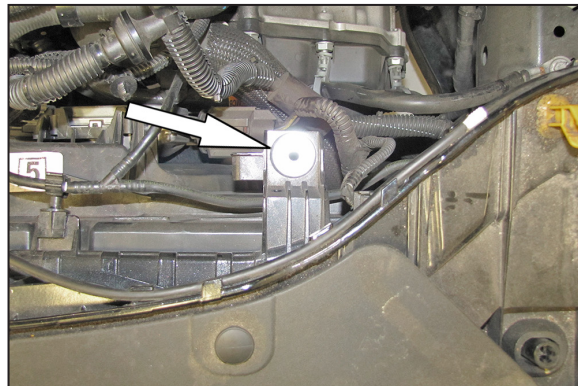

16. Place the provided rubber and fender washer onto the front air filter housing mount as shown

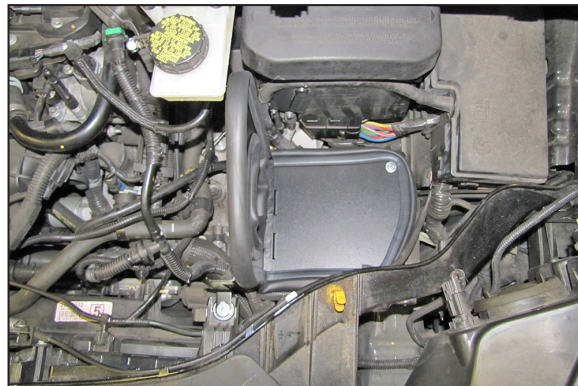

17. Install the heat shield assembly so that the mounting studs insert into the air box mounting grommets and then secure with the provided hardware. Tighten the bracket hardware left slightly loose in step #12.

**NOTE: Do not over tighten the mounting hardware.**

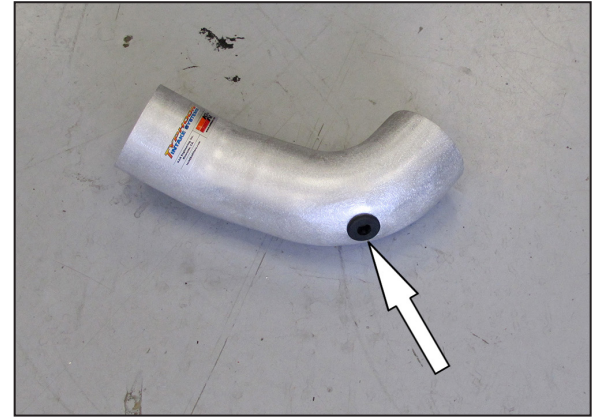

18. Install the provided grommet into the K&N® intake tube as shown.

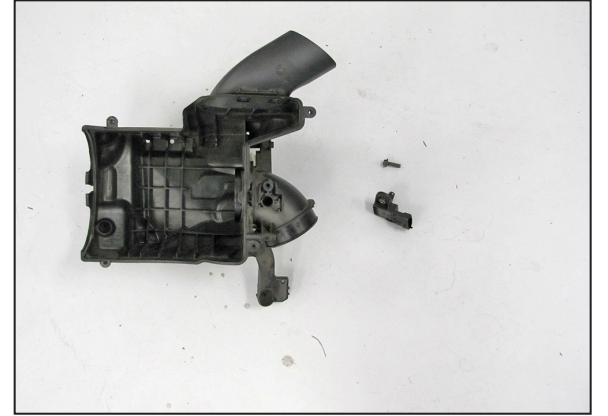

19. Remove the inlet air temperature sensor from the factory air filter housing.

**NOTE: there is two different style sensors, one sensor is held in with a mounting bolt and the other style sensor does not use a bolt. If your vehicle has the non-bolt style, rotate the sensor counter clockwise to unlock it.**



20. Install the inlet air temperature sensor into the grommet installed into the K&N® intake tube.



21. Install the K&N® intake tube through the heat shield and then into the coupling hose and secure with the provided hose clamp.

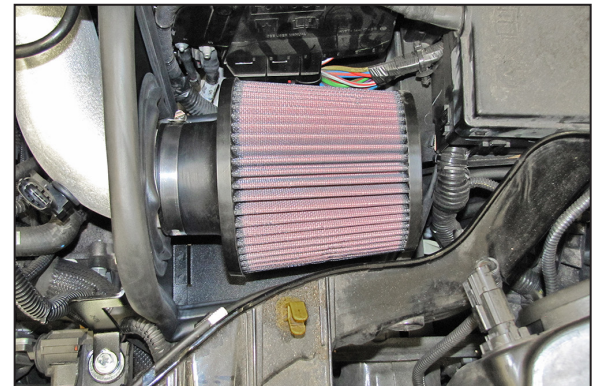

22. Install the K&N® air filter onto the K&N® intake tube and secure with the provided hose clamp. **NOTE: Drycharger® air filter wrap; part # RX-4990DK is available to purchase separately. To learn more about Drycharger® filter wraps or look up color availability please visit <http://www.knfilters.com>.**



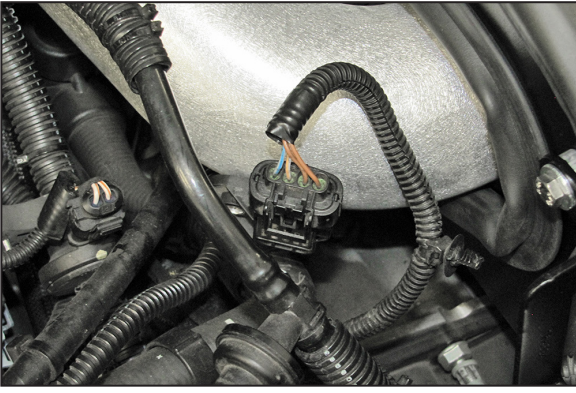

23. Reconnect the inlet air temperature sensor electrical connection.



24. Reinstall the decorative engine cover.



25. Reconnect the vehicle's negative battery cable. Double check to make sure everything is tight and properly positioned before starting the vehicle.

26. It will be necessary for all K&N® high flow intake systems to be checked periodically for realignment, clearance and tightening of all connections. Failure to follow the above instructions or proper maintenance may void warranty.

#### ROAD TESTING:

1. Start the engine with the transmission in neutral or park, and the parking brake engaged. Listen for air leaks or odd noises. For air leaks secure hoses and connections. For odd noises, find cause and repair before proceeding. This kit will function identically to the factory system except for being louder and much more responsive.

2. Test drive the vehicle. Listen for odd noises or rattles and fix as necessary.

3. If road test is fine, you can now enjoy the added power and performance from your kit.

4. K&N Engineering, Inc., requires cleaning the intake system's air filter element every 100,000 miles. When used in dusty or off-road environments, our filters will require cleaning more often. We recommend that you visually inspect your filter once every 25,000 miles to determine if the screen is still visible. When the screen is no longer visible some place on the filter element, it is time to clean it. To clean and re-oil, purchase our filter Recharger® service kit, part number 99-5050 or 99-5000 and follow the easy instructions.

**NOT LEGAL FOR SALE OR USE ON ANY POLLUTION CONTROLLED MOTOR VEHICLE IN CALIFORNIA OR STATES ADOPTING CALIFORNIA EMISSION PROCEDURES.**

See [knfilters.com](http://knfilters.com) for CARB status on each part for a specific vehicle