

TYPHOON INTAKE SYSTEMS®

BY 

INSTALLATION INSTRUCTIONS

69-3523

FORD

2005-08 MUSTANG GT

V8-4.6L

**NOTE: C.A.R.B.
E.O.#D-269-32 APPLIES
ONLY TO 2005-06
MODELS**

Tools

Flat Blade Screwdriver
Ratchet
Extension
8mm Socket
10mm Socket
10mm Wrench
2.5mm Allen Wrench

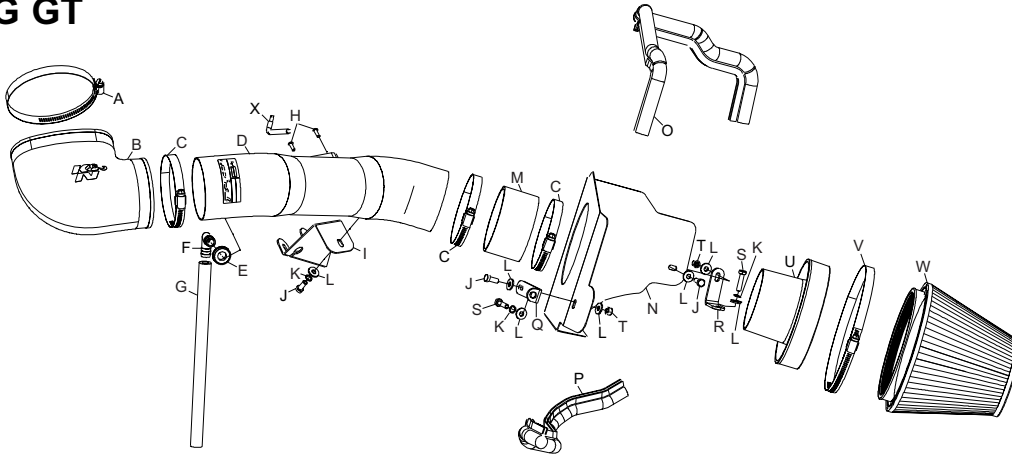

Parts list

Desc.	Qty.	Part #
A hose clamp #72	1	08671
B hose; oval to 3.5" id, 90 deg elbow	1	084094
C hose clamp #56	3	08620
D intake tube	1	27504
E grommet	1	08167
F hose mender; 90 deg	1	08065
G hose; 5/16" id x 21", silicone	1	08409
H bolt; m4-.7 x 12mm, b/h/a	2	07726
I bracket	1	26639
J bolt; 6mm-1.00 x 16mm SS hex	3	07812
K washer; wave 6mm	3	08277
L washer; flat ss 6mm	7	08269
M hose; 3.5" id x 2", silicone	1	084052
N heat shield	1	074038
O edge trim 30"	1	102489
P edge trim 23"	1	102495
Q bracket "L"	1	07158
R bracket "L"	1	070812
S bolt; 6mm-1.00 x 25mm hex ss	2	07858
T nut; 6mm nylock	2	07553
U adapter #452	1	21518
V hose clamp #104	1	08697
W air filter	1	RF-1048
X wrench; torx t20-t/r, l-key	1	69801

NOTE: FAILURE TO FOLLOW INSTALLATION INSTRUCTIONS AND NOT USING THE PROVIDED HARDWARE MAY DAMAGE THE INTAKE TUBE, THROTTLE BODY AND ENGINE.

TO START:

1. Turn the ignition OFF and disconnect the vehicle's negative battery cable.



2. Release the red locking tab and then disconnect the mass air sensor electrical connection.



3. Rotate the green locking tab clockwise and then disconnect the crank case breather hose from the valve cover as shown.



4. Loosen the hose clamps, which secure the intake tube to the throttle body and air box, then remove the intake tube as shown.

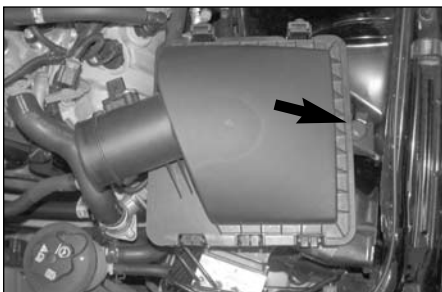

5. Remove the air box mounting bolt shown.



6. Remove the air box assembly as shown.

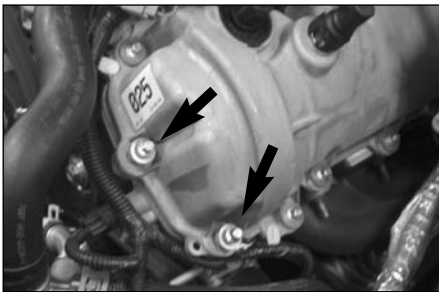

7. Remove the two valve cover bolts shown.
NOTE: These bolts will be reused.



8. Install the valve cover bolts removed in step #7 into the tube mounting bracket as shown passing through the key hole portion and then slide the bolts to the end of the slots.



9. Install the tube-mounting bracket onto the valve cover as shown and secure with the stock hardware removed in step #7.

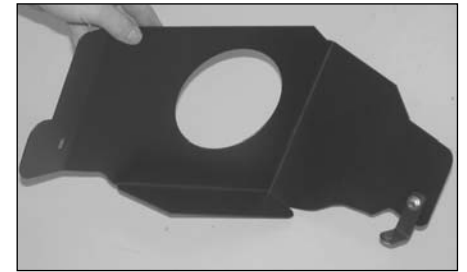

10. Install the "L" bracket (070812) onto the rear of the heat shield as shown with the provided hardware.



11. Install the "L" bracket (07158) onto the front of the heat shield as shown with the provided hardware.

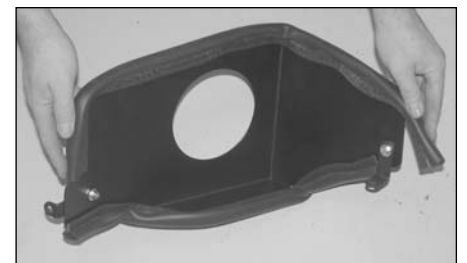

12. Install the edge trim onto the heat shield as shown.

NOTE: Some trimming of the edge trim may be necessary for proper fit.

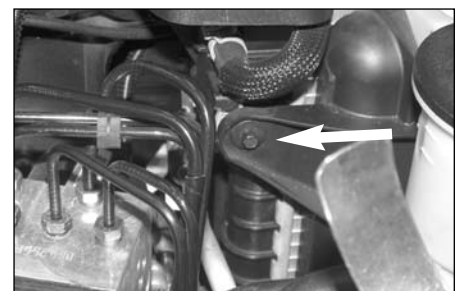

13. Remove the radiator fan shroud mounting bolt shown.

NOTE: This bolt will not be reused.



14. Install the heat shield and secure with the provided hardware as shown.

NOTE: The forward mounting bracket will mount to the radiator fan shroud mounting location and the rear bracket will mount to the air box mounting location.

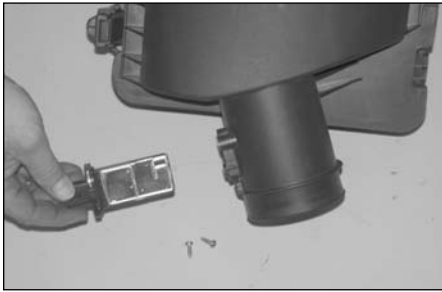

15. Remove the mass air sensor from the factory air box with the T20 "TORX" wrench provided.

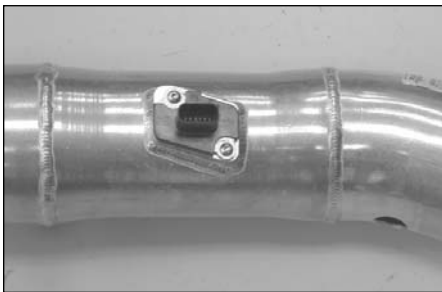

16. Install the mass air sensor into the K&N intake tube with the provided hardware as shown.



17. Install the grommet provided into the K&N intake tube as shown.



18. Install the silicone hose (084094) onto the throttle body with the provided hose clamp as shown.

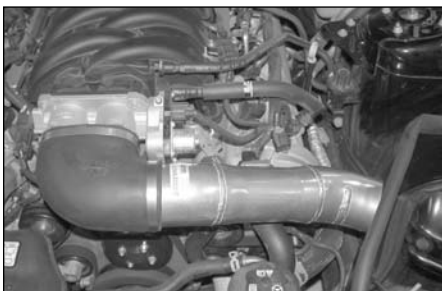

19. Install the K&N intake tube into the silicone hose at the throttle body and onto the mounting bracket installed in step #9, then secure with provided hose clamp and 6mm bolt.



20. Install the provided 90 deg hose mender into the provided crankcase vent hose as shown.



21. Install the crank case vent hose mender into the grommet installed in the K&N intake tube and then onto the valve cover as shown.

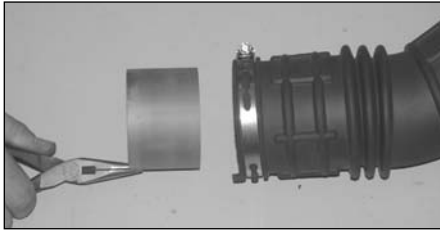

22. This step only applies to 2005 models equipped with an air box part number of 4R33-9C662-BJ or 4R33-9C662-CF, use a pair of needle nose pliers and remove the Hydrocarbon trap from the stock intake tube as shown.

NOTE: The Hydrocarbon trap coating is very fragile; care should be taken during removal as not to damage it.

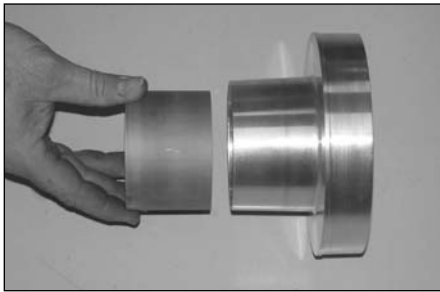

23. Place the Hydrocarbon trap into the filter adapter as shown.

NOTE: On models equipped with a Hydrocarbon trap, it is required that it be reinstalled for legal installation of this intake kit. Failure to install the Hydrocarbon trap may result in poor engine performance..



24. Install the silicone hose (084052) onto the filter adapter and secure with the provided hose clamp as shown.



25. Install the air filter onto the filter adapter and secure with the provided hose clamp as shown.



26. Install the air filter assembly onto the K&N intake tube as shown and secure with the provided hose clamp.



27. Reconnect the mass air sensor electrical connection as shown.



28. Re-connect the negative battery cable and double check that everything is tight and properly positioned before starting the vehicle.

29. The C.A.R.B. exemption sticker, (attached), must be visible under the hood, so that an emissions inspector can see it when the vehicle is required to be tested for emissions. California requires testing every two years, other states may vary.

30. It will be necessary for all Typhoons to be checked periodically for realignment, clearance and tightening of all connections. Failure to follow the above instructions or proper maintenance may void warranty.

ROAD TESTING:

1. Start the engine with the transmission in neutral or park, and the parking brake engaged. Listen for air leaks or odd noises. For air leaks secure hoses and connections. For odd noises, find cause and repair before proceeding. This kit will function identically to the factory system except for being louder and much more responsive.

2. Test drive the vehicle. Listen for odd noises or rattles and fix as necessary.

3. If road test is fine, you can now enjoy the added power and performance from your kit.

4. K&N suggests checking the Air filter element periodically for excessive dirt build-up. When the element becomes covered in dirt (or once a year), service it according to the instructions on the Recharger service kit, part number 99-5000 or 99-5050.

FREE K&N DECAL To register your warranty, please see us online at knfilters.com/register. FREE K&N DECAL