



TYPHOON INTAKE SYSTEMS

NOT LEGAL FOR SALE OR USE ON ANY POLLUTION CONTROLLED MOTOR VEHICLE IN CALIFORNIA OR STATES ADOPTING CALIFORNIA EMISSION PROCEDURES. See knfilters.com for CARB status on each part for a specific vehicle

INSTALLATION INSTRUCTIONS

69-2550TTK

DODGE

2015 Challenger SRT8 HELLCAT

2015 Charger SRT8 HELLCAT

V8-6.2L Supercharged

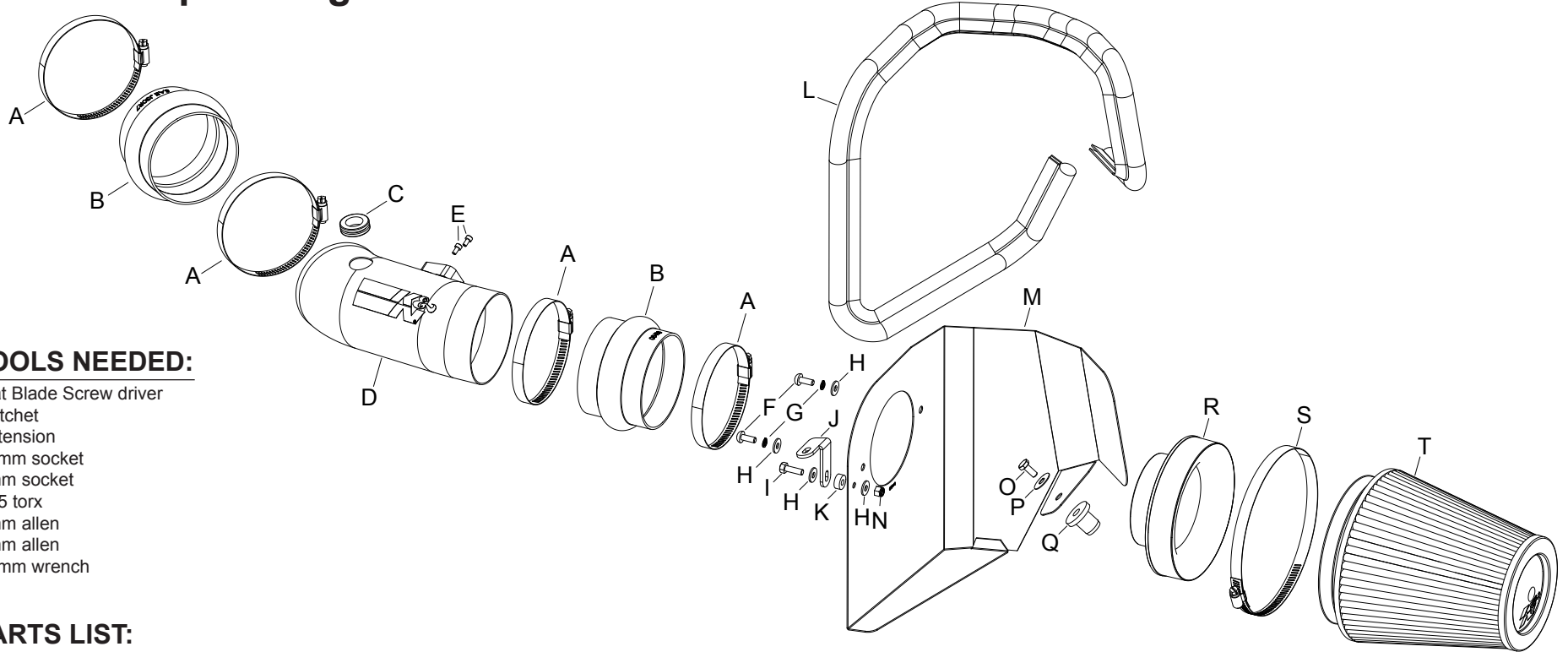

TOOLS NEEDED:

- Flat Blade Screw driver
- Ratchet
- Extension
- 14mm socket
- 8mm socket
- T15 torx
- 4mm allen
- 3mm allen
- 10mm wrench

PARTS LIST:

Description	Qty.	Part #	Description	Qty.	Part #	Description	Qty.	Part #
A hose clamp #64, black zinc	4	08645K	H washer; 6mm flat, ss	4	08269	O bolt; 3/8"-16 x 1-1/4"l ss hex head	1	07779
B hose; 4" id x 3" l hump reinforced	2	08418	I bolt; m6 x 1.00" x 20mm hex, ss	1	07795	P washer; 3/8" flat washer, ss	1	08134
C grommet; 3/4" id	1	08058	J bracket; "l", 69-2550, stl, tb/pc	1	064330	Q insert; 3/8-16 x 3/400 x 15/16l	1	08163
D intake tube	1	27564TK	K spacer: .625" od x .250" id x .250" l	1	06555	R adaptor; 57-3058 #454	1	27300
E bolt; m4 - 0.07 8mm, a/h cap, ss	2	07733	L edge trim (55")	1	102480	S hose clamp #104, black zinc	1	08697K
F bolt; m6 x 1.00 x 16mm, ss	2	07730	M heat shield	1	073190	T air filter	1	RF-1041
G washer, m6 split lock zinc	2	1-3025	N nylock nut	1	07512			

NOTE: FAILURE TO FOLLOW INSTALLATION INSTRUCTIONS AND NOT USING THE PROVIDED HARDWARE MAY DAMAGE THE INTAKE TUBE, THROTTLE BODY AND ENGINE.

TO START:

1. Turn off the ignition and disconnect the negative battery cable.
NOTE: Disconnecting the negative battery cable erases pre-programmed electronic memories. Write down all memory settings before disconnecting the negative battery cable. Some radios will require an anti-theft code to be entered after the battery is reconnected. The anti-theft code is typically supplied with your owner's manual. In the event your vehicles anti-theft code cannot be recovered, contact an authorized dealership to obtain your vehicles anti-theft code.

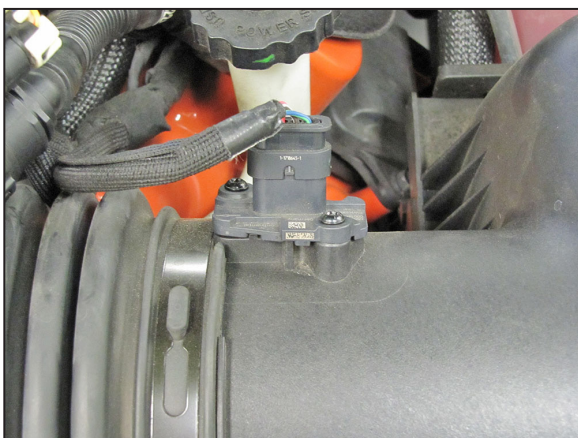

2. Disconnect the mass air sensor electrical connection.

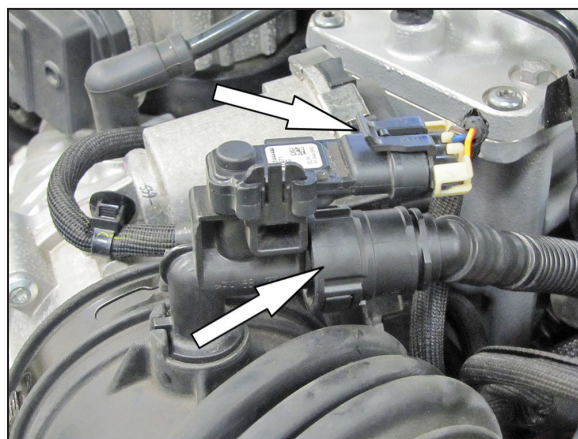

3. Disconnect the pressure sensor electrical connection and disconnect the crank case vent hose from the fitting.



4. Loosen the hose clamp securing the intake tube to the throttle body.

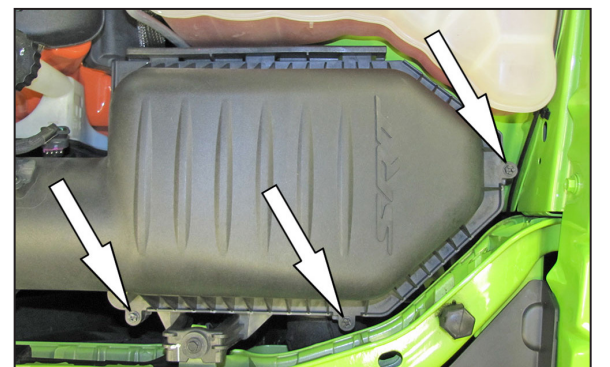

5. Loosen the three screws securing the upper air filter housing and then remove the upper air filter housing and intake tube.

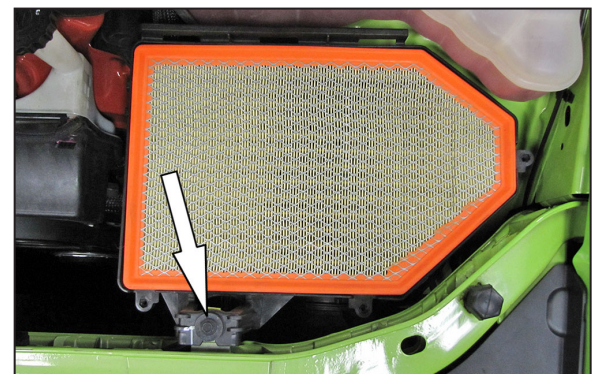

6. Remove the bolt securing the lower air filter housing to the core support and then remove the air filter housing from the vehicle.

NOTE: It may be helpful to separate the fresh air duct from the air filter housing to aid its removal. The factory bolt will be reused in a later step. On Charger models, the fresh air intake duct stays inside the vehicle.
NOTE: K&N Engineering, Inc., recommends that customers do not discard factory air intake.

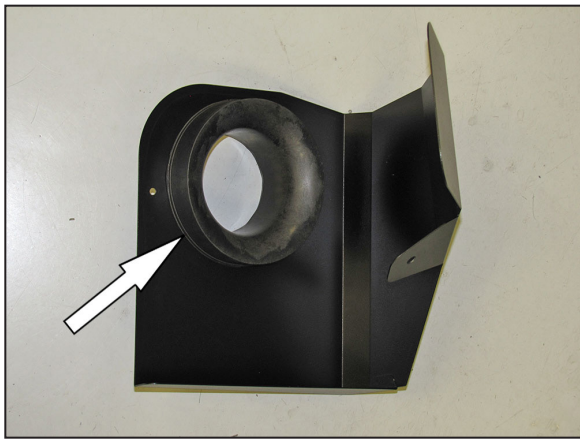

7. Install the filter adapter into the heat shield and secure with the provided hardware.

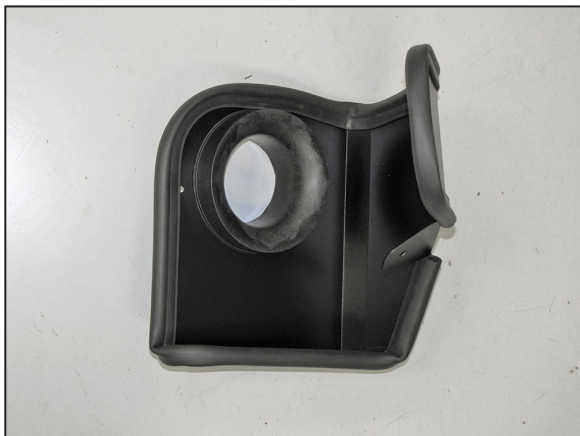

8. Install the provided edge trim onto the heat shield as shown.

NOTE: Trimming of the edge trim will be necessary.

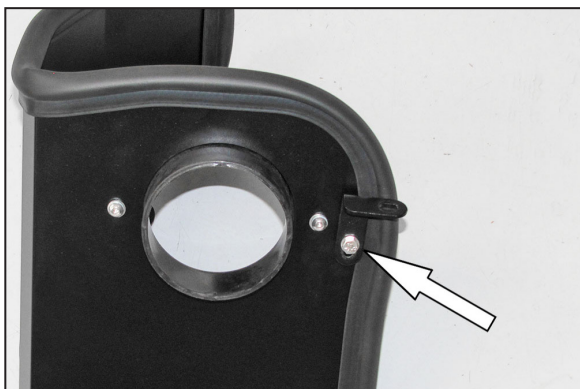

9. Install the heat shield mounting bracket (064330) onto the heat shield as shown.

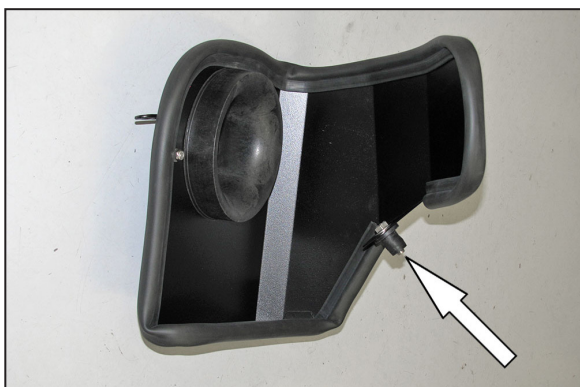

10. Install the Inserted nut onto the heat shield as shown.



11. Install the heat shield assembly into the vehicle so the insert nut goes into the factory air box grommet mount. Secure the bracket to the core support with the factory bolt from step #6 and tighten the bolt into the insert nut.

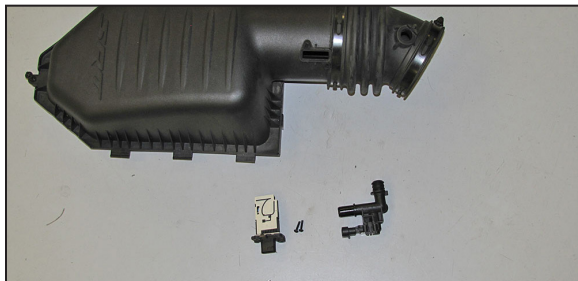

12. Remove the two screws securing the mass air sensor into the air filter housing and then remove the mass air sensor. Remove the pressure sensor/vent assembly from the factory intake hose as shown.



13. Install the mass air sensor into the K&N® intake tube and secure with the provided hardware.



14. Install the provided grommet and pressure sensor/vent assembly into the K&N® intake tube as shown.



15. Install both of the coupling hoses (08418) onto the K&N® intake tube as shown.

NOTE: Install the hose as far onto the tube as possible to aid the installation onto the vehicle.



16. Install the K&N® intake tube assembly into position. Slide the coupling hoses out and onto the throttle body and filter adapter. Then adjust the tube and hoses for proper fit and secure with the provided hose clamps.



17. Reconnect the crank case vent hose and pressure sensor electrical connection.

NOTE: Rotate the K&N® intake tube towards the rear of the vehicle and slide it towards the throttle body to provide the maximum amount of hood clearance, additional clearance can be achieved by rotating the crank case vent hose to adjust its position.

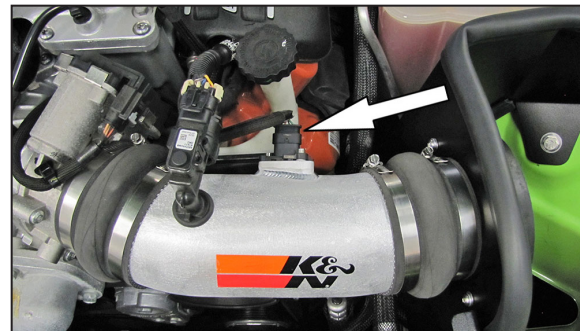

18. Reconnect the mass air sensor electrical connection.

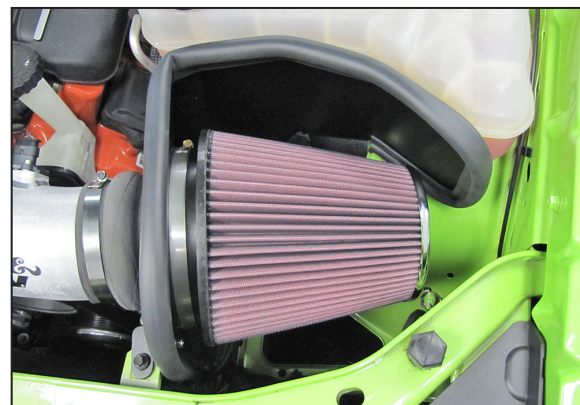

19. Install the K&N® air filter and secure with the provided hose clamp.

NOTE: Drycharger® air filter wrap; #RF-1041DK is available separately and is recommended if the vehicle is to be used in inclement weather. Protection of the air filter is recommended while washing the vehicle as the filter is exposed under the hood grill.



20. Reconnect the vehicle's negative battery cable. Double check to make sure everything is tight and properly positioned before starting the vehicle.

21. It will be necessary for all K&N® high flow intake systems to be checked periodically for realignment, clearance and tightening of all connections. Failure to follow the above instructions or proper maintenance may void warranty.

ROAD TESTING:

1. Start the engine with the transmission in neutral or park, and the parking brake engaged. Listen for air leaks or odd noises. For air leaks secure hoses and connections. For odd noises, find cause and repair before proceeding. This kit will function identically to the factory system except for being louder and much more responsive.

2. Test drive the vehicle. Listen for odd noises or rattles and fix as necessary.

3. If road test is fine, you can now enjoy the added power and performance from your kit.

4. K&N Engineering, Inc., requires cleaning the intake system's air filter element every 100,000 miles. When used in dusty or off-road environments, our filters will require cleaning more often. We recommend that you visually inspect your filter once every 25,000 miles to determine if the screen is still visible. When the screen is no longer visible some place on the filter element, it is time to clean it. To clean and re-oil, purchase our filter Recharger® service kit, part number 99-5050 or 99-5000 and follow the easy instructions.

NOT LEGAL FOR SALE OR USE ON ANY POLLUTION CONTROLLED MOTOR VEHICLE IN CALIFORNIA OR STATES ADOPTING CALIFORNIA EMISSION PROCEDURES.

See knfilters.com for CARB status on each part for a specific vehicle