



# TYPHOON INTAKE SYSTEMS

INTAKE SYSTEMS FOR VEHICLES LISTED ARE 50 STATE LEGAL. SEE KNFILTERS.COM FOR CARB STATUS ON EACH PART FOR A SPECIFIC VEHICLE.

## INSTALLATION INSTRUCTIONS

**69-1212TS**  
**HONDA**  
**2013-14 Accord**  
**V6-3.5L**

NOTE: Excludes LEV2 SULEV 2013-2014  
 Test Groups: DHNXV03.5VC3, EHNXV03.5SC3

**TOOLS NEEDED:**

- Ratchet
- Extension
- 12mm socket
- 10mm socket
- 8mm socket
- Flat Blade Screw Driver
- Phillips Screw Driver
- Pliers
- 3mm allen key
- 10mm wrench

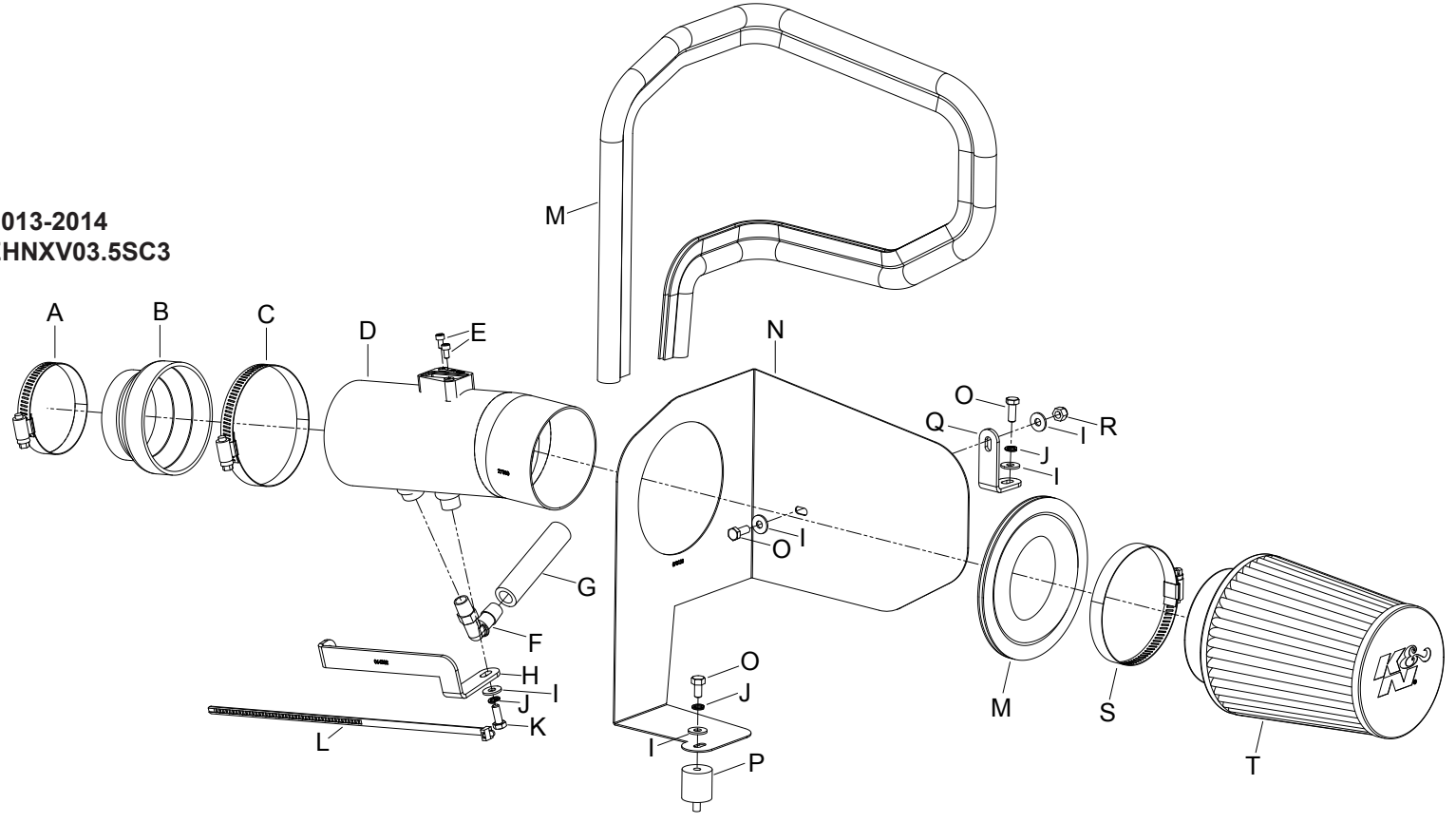

**PARTS LIST:**

Description	Qty.	Part #	Description	Qty.	Part #	Description	Qty.	Part #
A Hose Clamp #44	1	08560	H Bracket; "L", 69-1212, STL	1	064302	O Bolt; 6MM-1.00 X 16MM, SS	3	07812
B Hose; 3.5" to 2.75" X 2"L, Black	1	084093	I Washer; 6MM ,Flat,SS	5	08269	P Stud; Rubber Mount, M6 X 1	1	02033
C Hose Clamp #56	1	08620	J Washer; M6 Split Lock Zinc	3	1-3025	Q Bracket; 63-1025, Small, TB/PC	1	070015
D Intake Tube	1	27330TS	K Bolt; M6 X 1.00 X 12MM, SS	1	07727	R Nut; 6MM Nylock, Hexhead, SS	1	07512
E Bolt; M4-0.07 8MM, A/H, Cap,SS	2	07733	L Cable Ties; 11" Black	1	21590	S Hose Clamp #60	1	08624
F Vent; 90 DEG, 1/2: Hose, 1/4NPT	1	08110FK	M Edge Trim (61")	1	102492	T Air Filter	1	RC-4630XD
G Hose; 1/2" ID X 3-1/2"L	1	087028	N Heat Shield	1	073133			

**NOTE: FAILURE TO FOLLOW INSTALLATION INSTRUCTIONS AND NOT USING THE PROVIDED HARDWARE MAY DAMAGE THE INTAKE TUBE, THROTTLE BODY AND ENGINE.**

**TO START:**

1. Turn off the ignition and disconnect the negative battery cable.  
**NOTE: Disconnecting the negative battery cable erases pre-programmed electronic memories. Write down all memory settings before disconnecting the negative battery cable. Some radios will require an anti-theft code to be entered after the battery is reconnected. The anti-theft code is typically supplied with your owner's manual. In the event your vehicles' anti-theft code cannot be recovered, contact an authorized dealership to obtain your vehicles anti-theft code.**

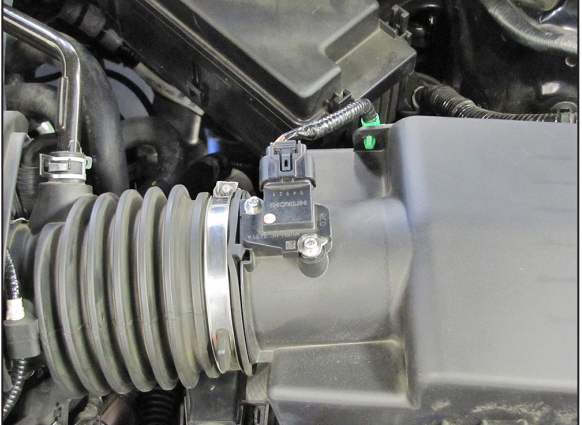

2. Disconnect the mass air sensor electrical connection and unhook the wiring harness from the air box.



3. Lift off the engine cover.

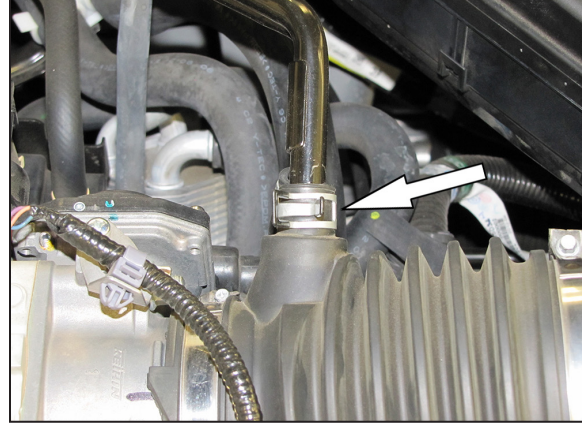

4. Disconnect the crank case vent tube from the intake hose.

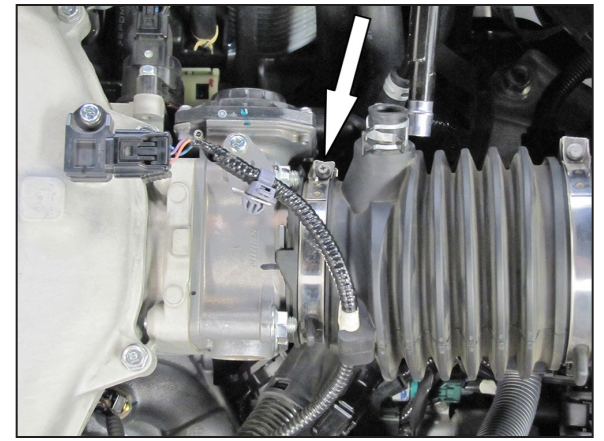

5. Loosen the hose clamp securing the intake hose to the throttle body and unhook the wiring harness from the intake hose.

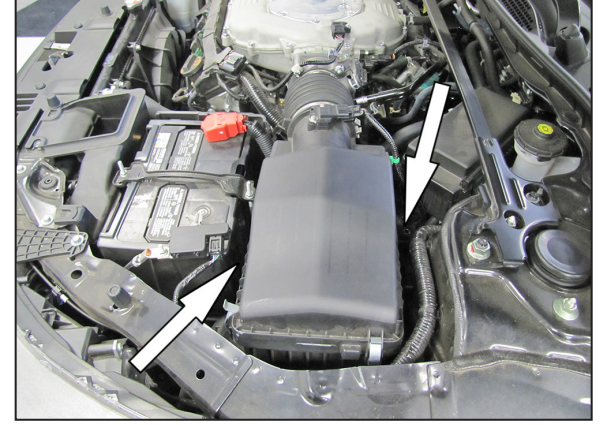

6. Loosen and remove the two air box mounting bolts.  
**NOTE: The front mounting bolt is down low between the battery and the air box.**



7. Lift up the air box half way out, then unhook the wiring harness from the air box and remove the air box assembly.

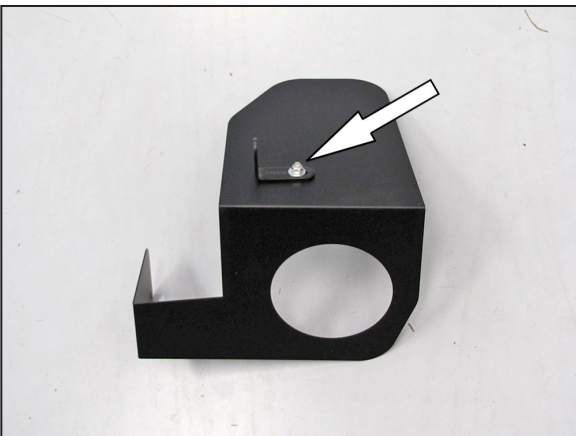

8. Install the heat shield mounting bracket (070015) onto the heat shield as shown.  
**NOTE: The longer leg of the bracket should be attached to the heat shield.**

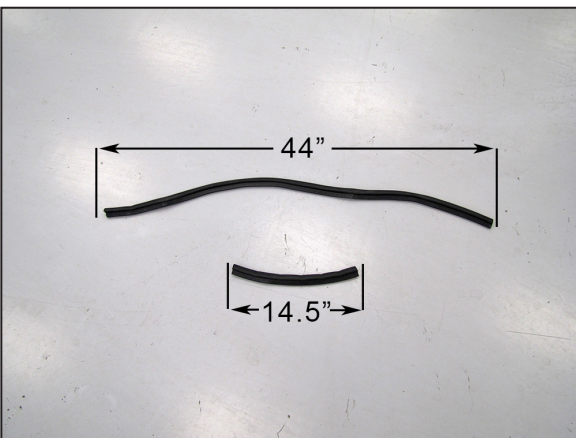

9. Cut the provided edge trim into two sections. One section will be 44" and one section will be 14.5" long.

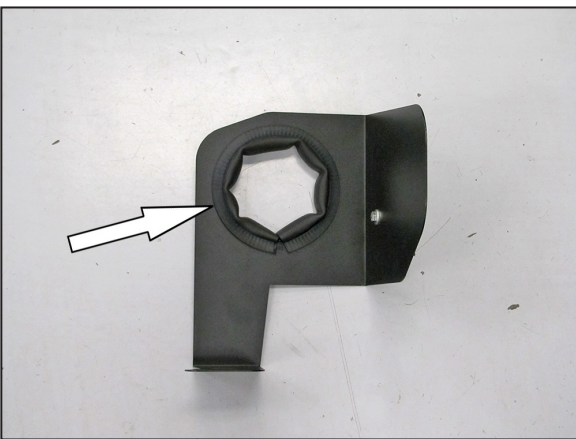

10. Install the 14.5" section of edge trim into the hole of the heat shield as shown.

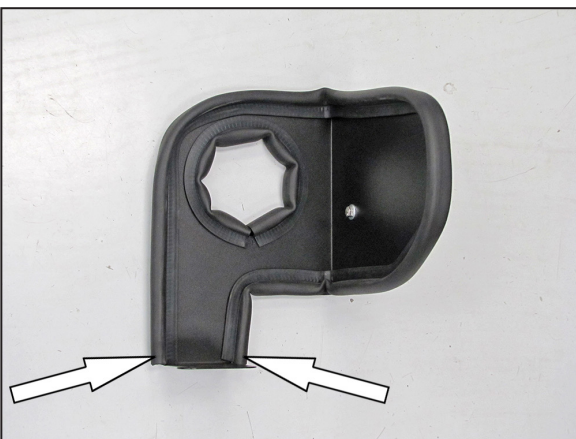

11. Install the 44" section of edge trim around the outer edge of the heat shield as shown.

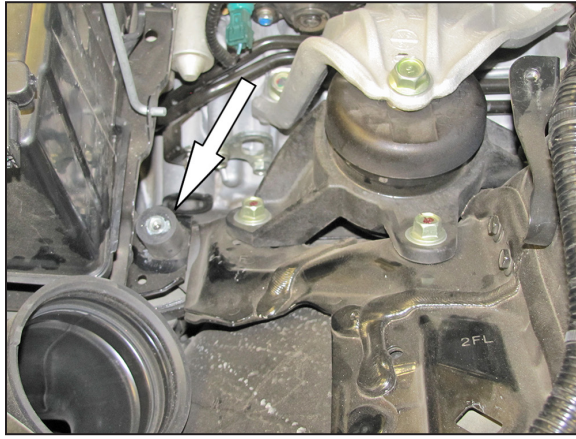

12. Install the provided rubber mounted stud onto the front air box mounting location as shown.

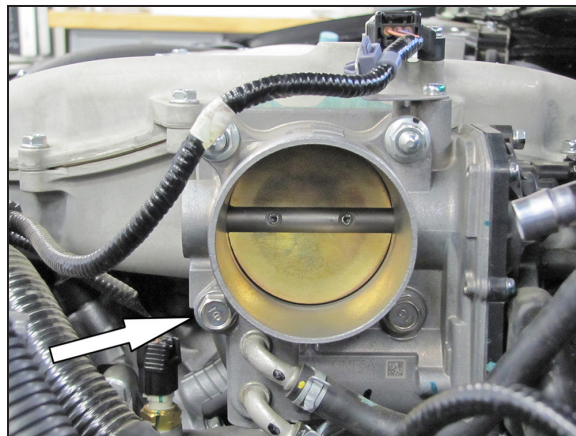

13. Remove the front lower throttle body mounting bolt.  
**NOTE: This bolt will be reused in the next step.**

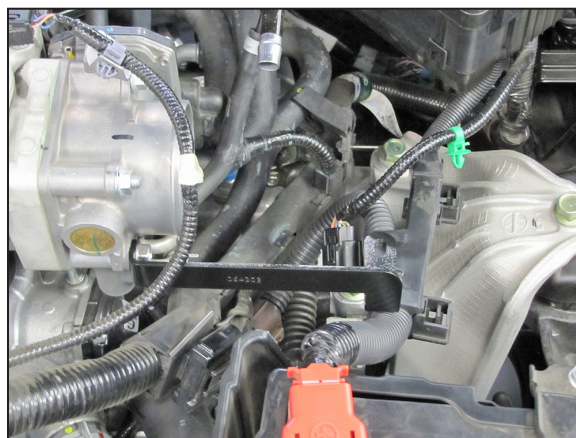

14. Install the provided tube mounting bracket (064302) onto the throttle body and secure with the factory bolt removed in the previous step.

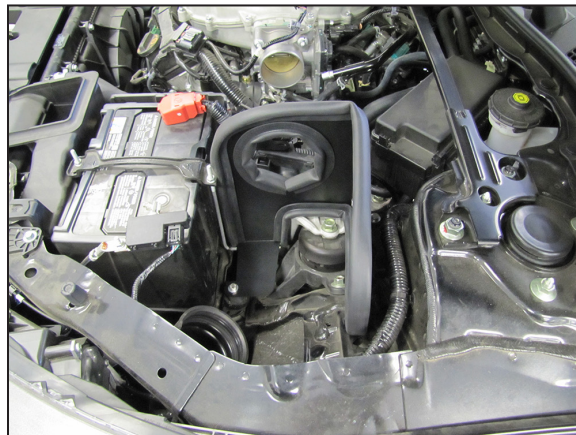

15. Set the heat shield into position on the rubber mounted stud and factory rear air box mounting location. Secure the heat shield with the provided hardware.



16. Install the provided silicone hose (084093) onto the throttle body and secure with the provided hose clamp.  
**NOTE: The hose is a tight fit onto the throttle body.**

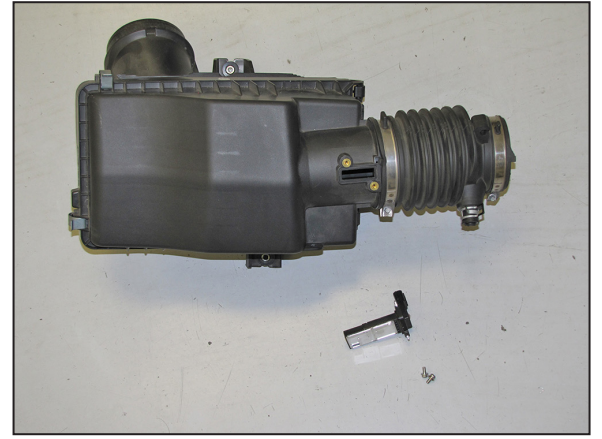

17. Remove the mass air sensor from the factory air box.



18. Install the mass air sensor into the K&N® intake tube and secure with the provided hardware.



19. Install the 90° vent fitting into the K&N® intake tube as shown.  
**NOTE: Plastic NPT fittings are easy to cross thread. Install the vent fitting "hand" tight, then turn it two complete turns with a wrench.**



20. Install the K&N® intake tube through the heat shield and then into the silicone hose, and then align with the mounting bracket. Secure the tube with the provided hose clamp and hardware.



21. Using the provided tie wrap, Secure the wiring harness to the tube mounting bracket.

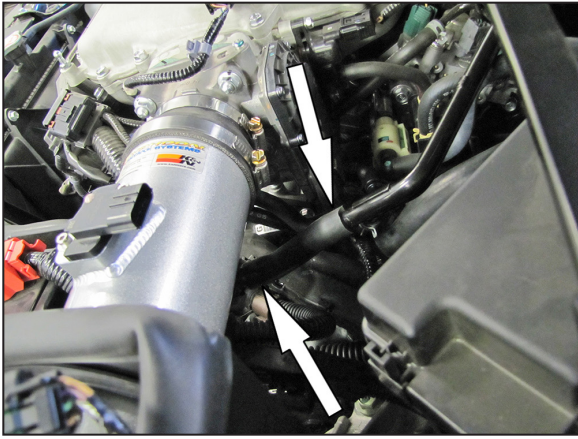

22. Connect the provided crank case vent hose to the factory vent tube and then connect the open end to the 90° vent fitting installed into the K&N® intake tube.

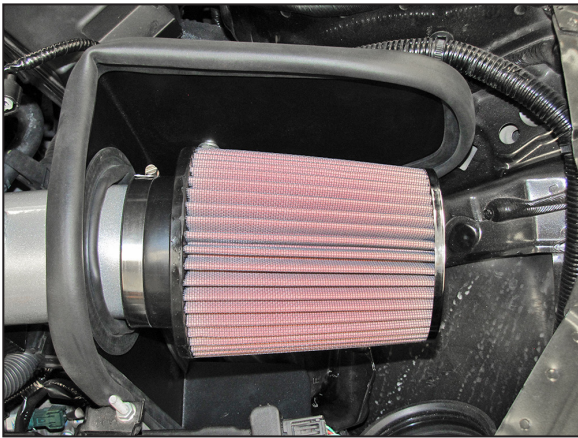

23. Install the K&N® air filter onto the K&N® intake tube and secure with the provided hose clamp.

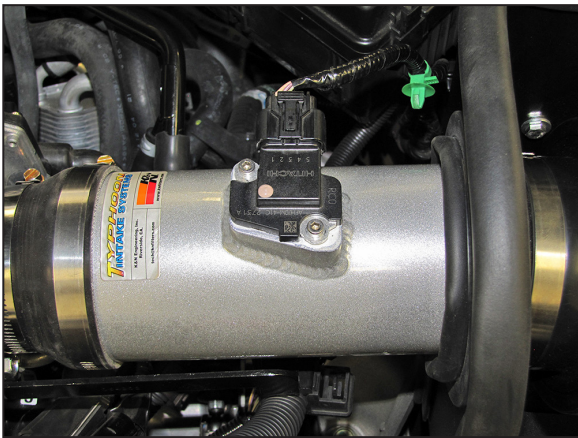

24. Reconnect the mass air sensor electrical connection.



25. Reinstall the engine cover.

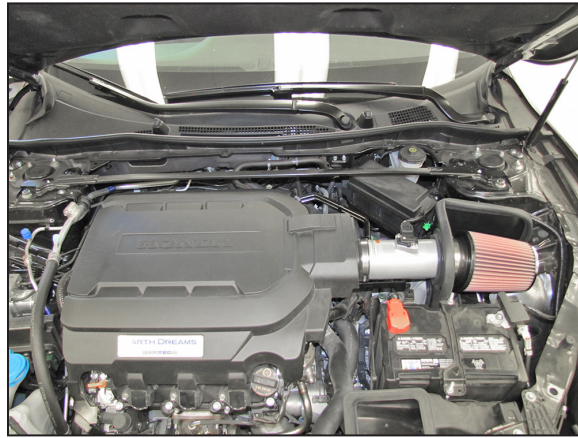

26. Reconnect the vehicle's negative battery cable. Double check to make sure everything is tight and properly positioned before starting the vehicle.

27. The C.A.R.B. exemption sticker, (attached), must be visible under the hood so that an emissions inspector can see it when the vehicle is required to be tested for emissions. California requires testing every two years, other states may vary.

28. It will be necessary for all K&N® high flow intake systems to be checked periodically for realignment, clearance and tightening of all connections. Failure to follow the above instructions or proper maintenance may void warranty.

#### ROAD TESTING:

1. Start the engine with the transmission in neutral or park, and the parking brake engaged. Listen for air leaks or odd noises. For air leaks secure hoses and connections. For odd noises, find cause and repair before proceeding. This kit will function identically to the factory system except for being louder and much more responsive.

2. Test drive the vehicle. Listen for odd noises or rattles and fix as necessary.

3. If road test is fine, you can now enjoy the added power and performance from your kit.

4. K&N Engineering, Inc., requires cleaning the intake system's air filter element every 100,000 miles. When used in dusty or off-road environments, our filters will require cleaning more often. We recommend that you visually inspect your filter once every 25,000 miles to determine if the screen is still visible. When the screen is no longer visible some place on the filter element, it is time to clean it. To clean and re-oil, purchase our filter Recharger® service kit, part number 99-5050 or 99-5000 and follow the easy instructions.

**INTAKE SYSTEMS FOR VEHICLES LISTED ARE 50 STATE LEGAL. SEE KNFILTERS.COM FOR CARB STATUS ON EACH PART FOR A SPECIFIC VEHICLE.**