



TYPHOON INTAKE SYSTEMS



INSTALLATION INSTRUCTIONS

69-1013 HONDA 2006-11 Civic L4-1.8L

C.A.R.B. E.O.# D-269-37
APPLIES ONLY to 2006-2010
Model Year Vehicles

TOOLS NEEDED:

Flat blade Screwdriver
Pliers
Ratchet
6" Extension
5.5mm Socket
8mm Socket
10mm Socket
3mm Allen Wrench
4mm Allen Wrench

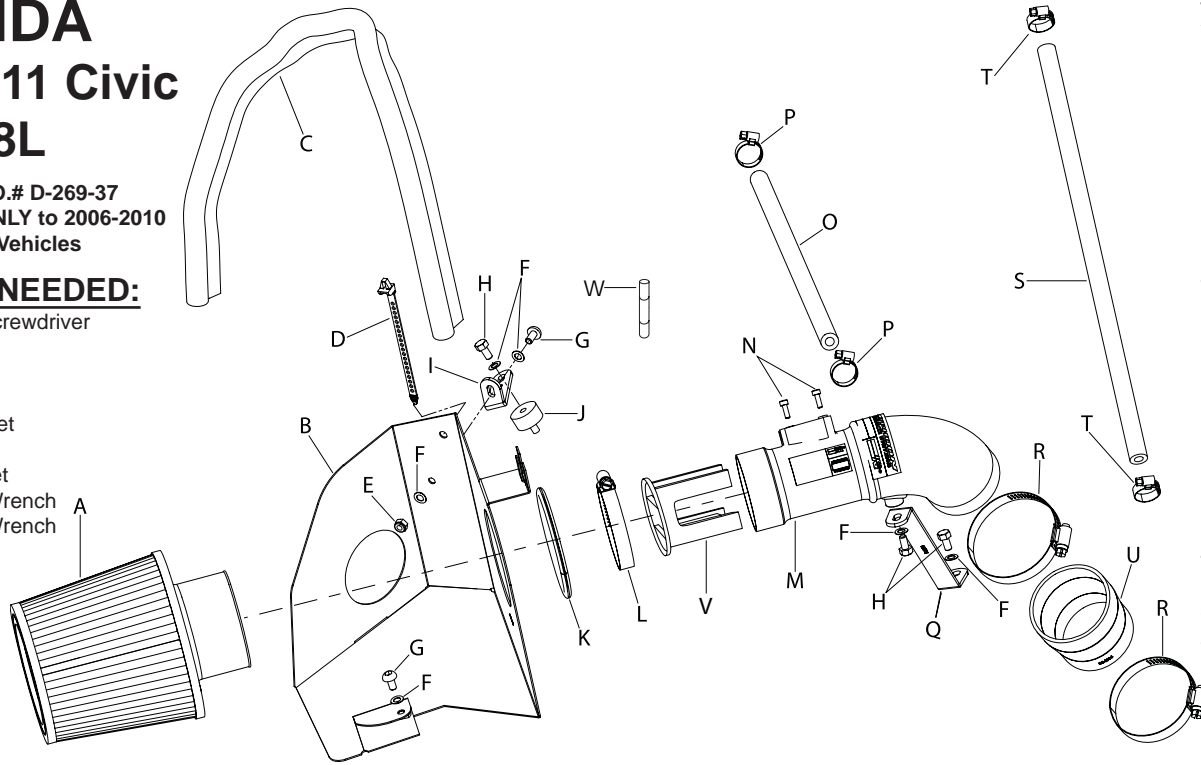

PARTS LIST:

| | Description | Qty. | Part # |
|---|-----------------------------------|------|---------|
| A | Air Filter | 1 | RU-4950 |
| B | Heat Shield | 1 | 07343 |
| C | Edge Trim 30"L | 1 | 102489 |
| D | Cable Tie, Push Mount | 1 | 21594 |
| E | Nut, Nylock, SS | 1 | 07512 |
| F | Washer 6mm Wave, SS | 6 | 08277 |
| G | Bolt; 6mm Buttonhead, SS | 2 | 07794 |
| H | Bolt; 6mm Hexhead, SS | 3 | 07727 |
| I | Bracket, "L" | 1 | 020015 |
| J | Vibration Mount, M/F 6mm | 1 | 070228 |
| K | Edge Trim (Small) 12"L | 1 | 102466 |
| L | Hose Clamp #44 | 1 | 08577 |
| M | Intake Tube | 1 | 27521-1 |
| N | Bolt, 4mm Caphead, SS | 2 | 07733 |
| O | Hose, 5/8"ID X 7-1/2"L, Silicone | 1 | 084008 |
| P | Hose Clamp #8 | 2 | 08410 |
| Q | Bracket, "Z" | 1 | 020016 |
| R | Hose Clamp #40 | 2 | 08554 |
| S | Hose, 5/16"ID X 17-1/4"L, Coolant | 1 | 5-2017 |
| T | Hose Clamp #6 | 2 | 08407 |
| U | Hose, Step, 2-1/2"ID To 2-3/4"ID | 1 | 084016 |
| V | Venturi, MAF Insert, 2.5" | 1 | 9-686 |
| W | Super Glue, 3G Drip Proof | 1 | 409 |

NOTE: On automatic transmission equipped vehicles, the transmission dipstick will be concealed by the intake kit heat shield.

NOTE: FAILURE TO FOLLOW INSTALLATION INSTRUCTIONS AND NOT USING THE PROVIDED HARDWARE MAY DAMAGE THE INTAKE TUBE, THROTTLE BODY AND ENGINE.

TO START:

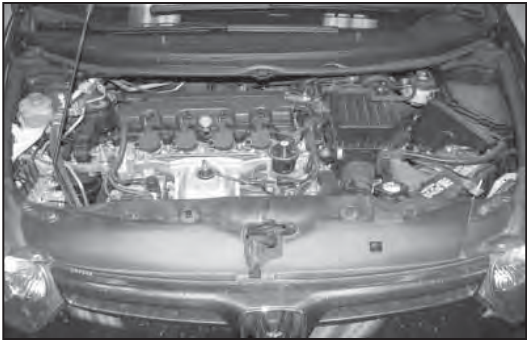

1. Turn off the ignition and disconnect the negative battery cable.

NOTE: Disconnecting the negative battery cable erases pre-programmed electronic memories. Write down all memory settings before disconnecting the negative battery cable. Some radios will require an anti-theft code to be entered after the battery is reconnected. The anti-theft code is typically supplied with your owner's manual. In the event your vehicles' anti-theft code cannot be recovered, contact an authorized dealership to obtain your vehicles anti-theft code.

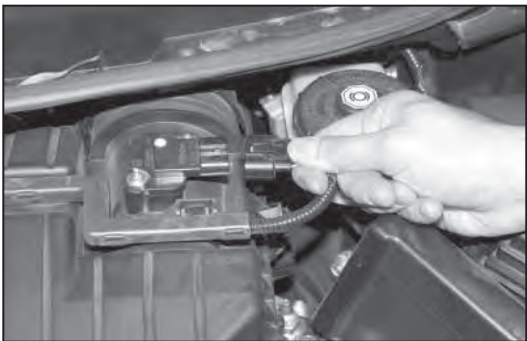

2. Disconnect the MAF sensor.

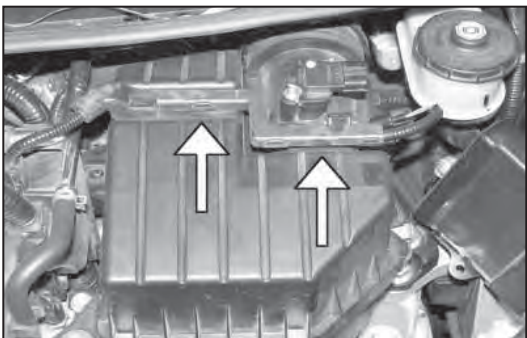

3. Press the two tabs that hold the MAF sensor wire harness to the factory airbox and unclip.

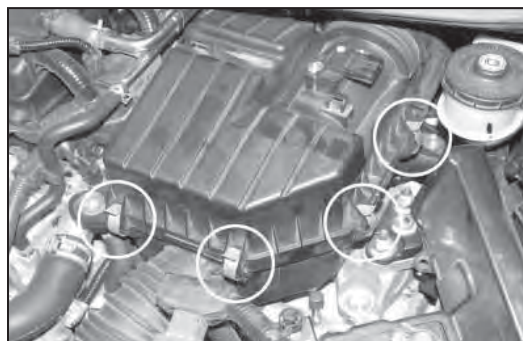

4. Unclip the four clips that secure the upper airbox in place, then remove the upper factory airbox.

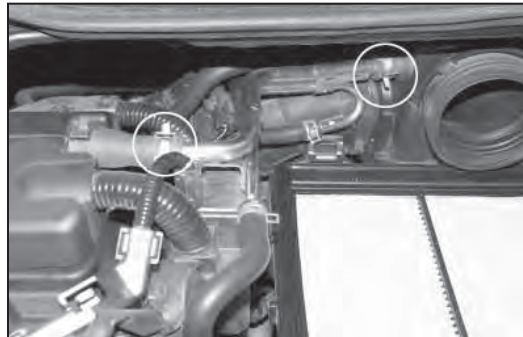

5. Unclip the two clips that secure the CCV-hose (one is located on the engine's valve cover, the other is located on the lower factory airbox) and disconnect the CCV-hose

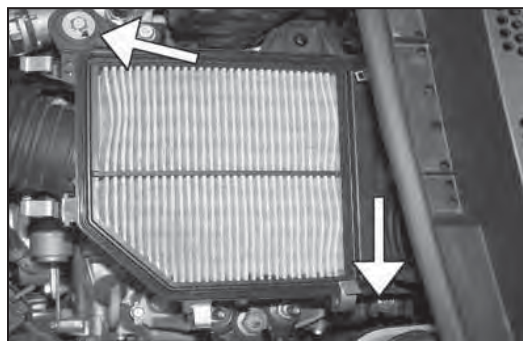

6. Loosen and remove the two bolts that secure the lower factory airbox to the vehicle.

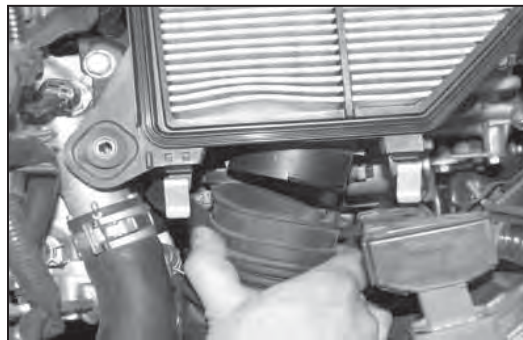

7. Remove the air inlet hose from the lower factory airbox.

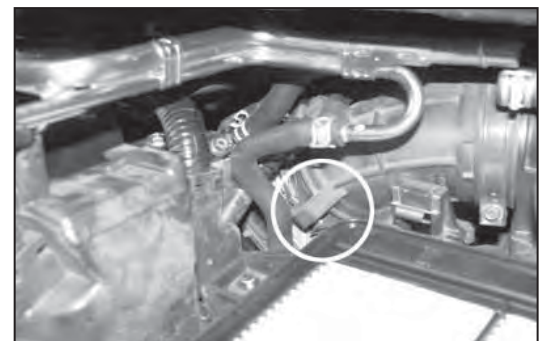

8. Using the 5.5mm socket and short extension, loosen the hose clamps that secure the factory intake tube to the throttle body.

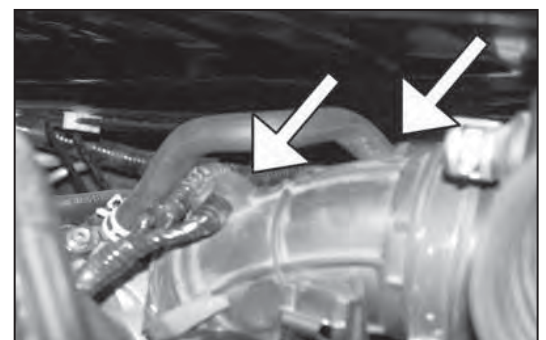

9. Unclip the EVAP canister hose and two wire harnesses from the factory intake tube.



10. Pull up and twist downward to remove the lower factory airbox and intake tube.

NOTE: K&N Engineering, Inc., recommends that customers do not discard factory air intake.

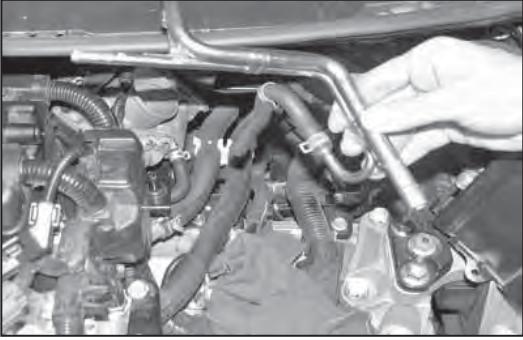
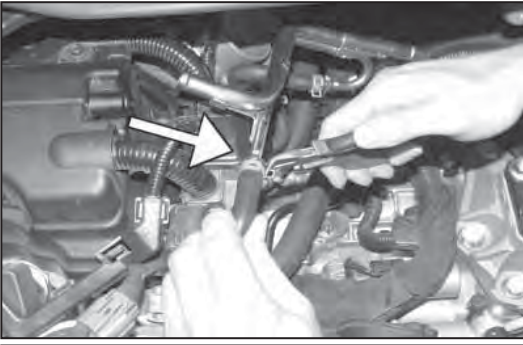

11. Using pliers, remove the coolant hose from the thermostat housing and the throttle body adaptor (a small amount of coolant may drain, have a cup ready to catch the fluid).

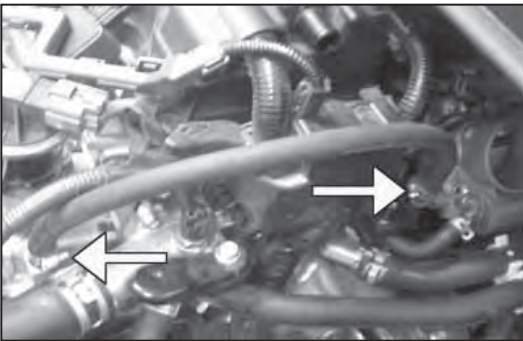

12. Install the provided coolant hose and secure with provided hose clamps.

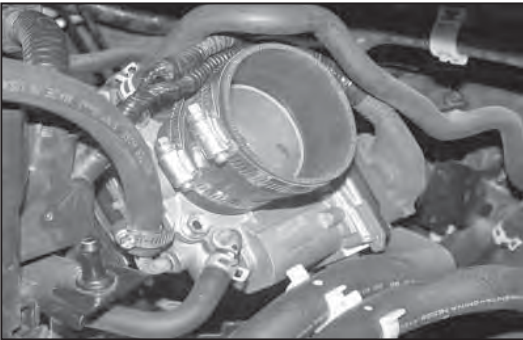

13. Install the silicone hose and hose clamps onto the throttle body as shown.

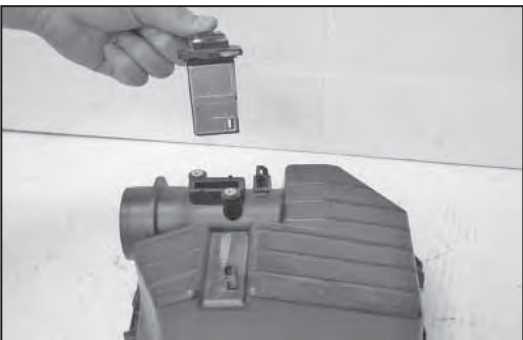

14. Loosen and remove the two screws that hold the MAF sensor to the factory airbox and remove the MAF sensor.

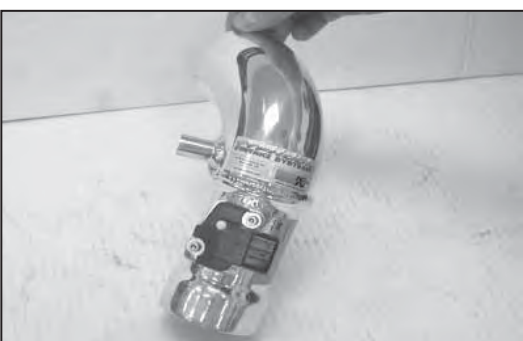

15. Secure the MAF sensor to the K&N intake tube with the provided hardware.



15a. Install the provided venturi into the end of the intake tube as shown.

NOTE: Apply a thin coat of the provided super glue to the lip of the venturi.



16. Attach the "Z" bracket to the K&N intake tube using the provided hardware.

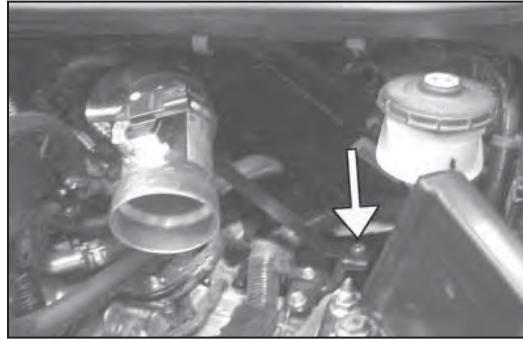

17. Install the K&N intake tube into the vehicle. Attach the bracket to the threaded hole from the factory airbox mounting point. Tighten hose clamps at the throttle body.

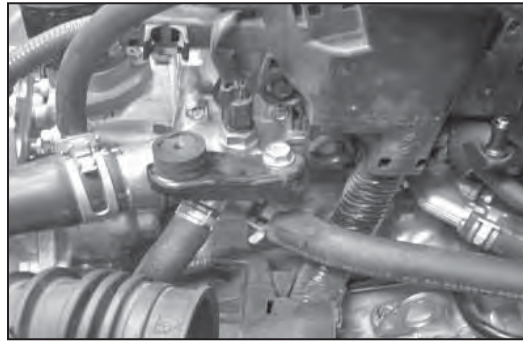

18. Secure the rubber mounted stud onto the other factory airbox mounting point.

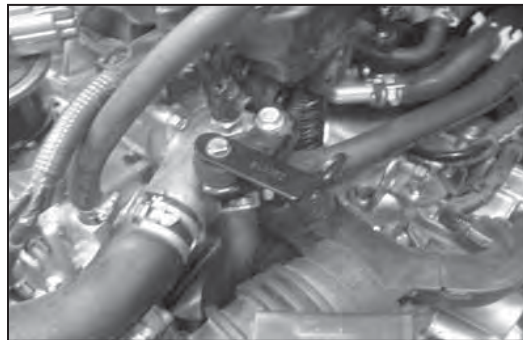

19. Install the "L" bracket onto the rubber mounted stud as shown.



20. Attach the large edge trim around the heat shield as shown. Install the small edge trim into the inner hole. It will be necessary to trim the edge trim for proper fit.



21. Loosen the positive battery cable and unclip the battery wire harness, adjust battery cable as shown. Then resecure the battery.

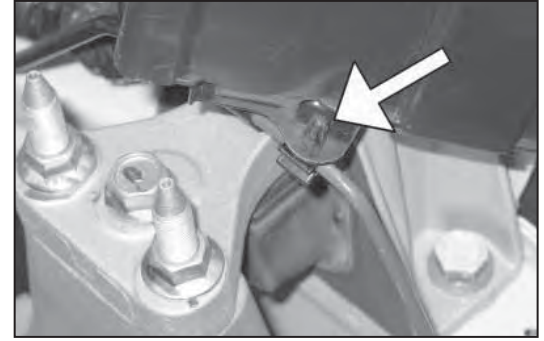

22. Unclip hydraulic line from clip and then remove the clip from the vehicle.

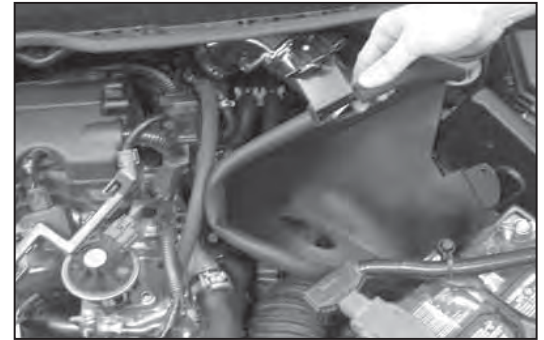
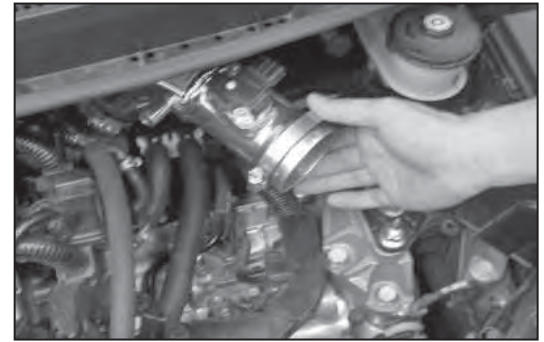

23. Slide the provided hose clamp onto the K&N intake tube, then install the heat shield. **NOTE: On automatic transmission equipped vehicles, it will be necessary to remove the air filter and heat shield from the vehicle to check the transmission fluid level.**

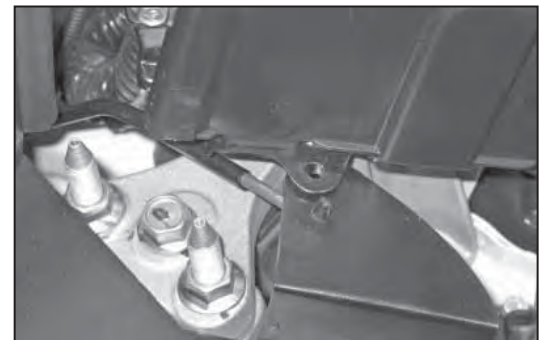

24. Install clip to the hydraulic line then attach to hole in heat shield.



25. Attach the "L" bracket to the heat shield, and then install a bolt through the the hole on the ECU bracket to the threaded boss on the heat shield. Then attach the factory air inlet hose to the heat shield.

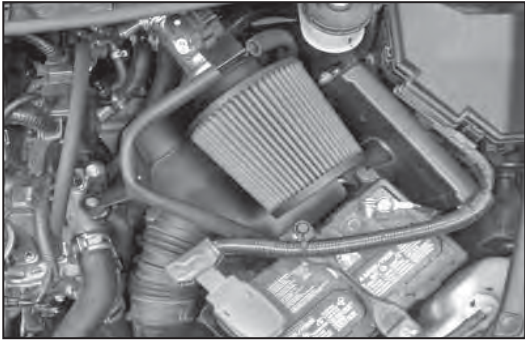

26. Install the air filter onto the K&N® intake tube.

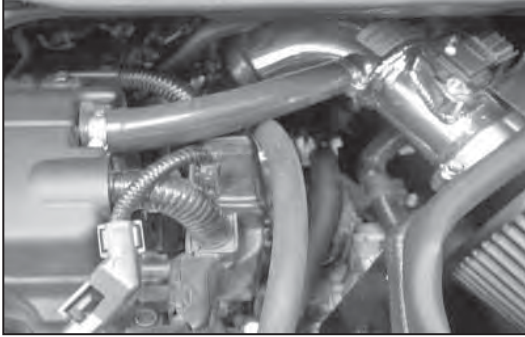

27. Attach the provided CCV-hose with #8 hose clamps, from the engine valve cover to the K&N® intake tube as shown.

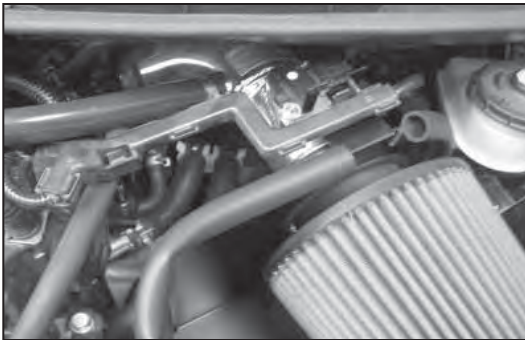

28. Adjust for best fit and clearance and secure all hardware and hose clamps.

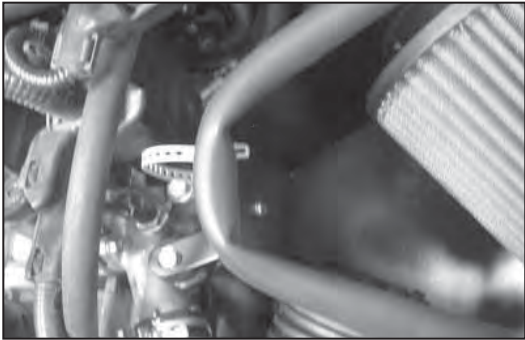

29. Install cable tie to the heat shield, then secure to the hose as shown.

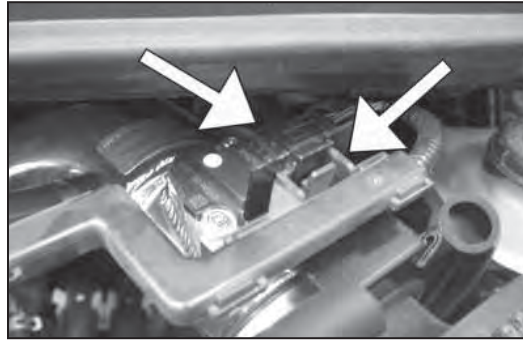

30. Reconnect the MAF sensor, then clip on the harness cover onto the heat shield bracket.

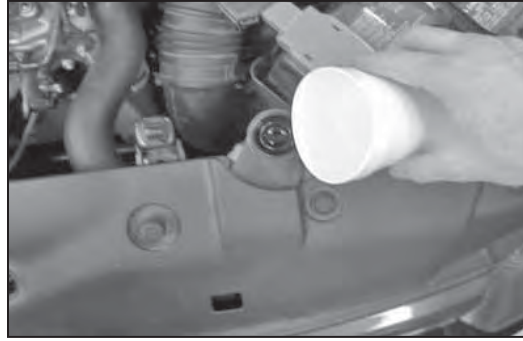

31. Loosen and remove the radiator cap to replace the coolant drained from step #11.



32. Resecure the radiator cap.

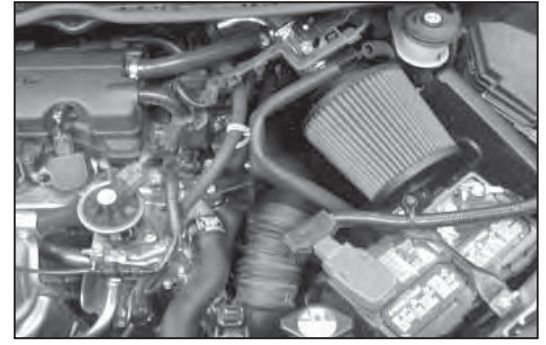

33. Reconnect the vehicle's negative battery cable. Double check to make sure everything is tight and properly positioned before starting the vehicle.

34. The C.A.R.B. exemption sticker, (attached), must be visible under the hood so that an emissions inspector can see it when the vehicle is required to be tested for emissions. California requires testing every two years, other states may vary.

35. It will be necessary for all K&N® high flow intake systems to be checked periodically for realignment, clearance and tightening of all connections. Failure to follow the above instructions or proper maintenance may void warranty.

ROAD TESTING:

1. Start the engine with the transmission in neutral or park, and the parking brake engaged. Listen for air leaks or odd noises. For air leaks secure hoses and connections. For odd noises, find cause and repair before proceeding. This kit will function identically to the factory system except for being louder and much more responsive.

2. Test drive the vehicle. Listen for odd noises or rattles and fix as necessary.

3. If road test is fine, you can now enjoy the added power and performance from your kit.

4. K&N Engineering, Inc., suggests checking the air filter element periodically for excessive dirt build-up. When the element becomes covered in dirt (or once a year), service it according to the instructions on the Recharger® service kit, part number 99-5050 or 99-5000.

STREET LEGAL IN MOST STATES

**NOT LEGAL FOR USE IN CA & OTHER STATES
ADOPTING CA EMISSIONS STANDARDS**

See our catalog or knfilters.com for CARB status on each part for a specific vehicle

* FREE K&N® decal To register your warranty, please see us online at knfilters.com/register. FREE K&N® decal *

• 1455 CITRUS ST., P.O. BOX 1329, RIVERSIDE, CA., U.S.A. 92502 • TECH SERVICE 800-858-3333 • FAX 951-826-4001
• e-mail: tech@knfilters.com • WWW: <http://www.knfilters.com>

18571J
10/24/11