



AIRCHARGER®

HIGH-FLOW INTAKE KITS

NOT LEGAL FOR SALE OR USE ON ANY POLLUTION CONTROLLED MOTOR VEHICLE IN CALIFORNIA OR STATES ADOPTING CALIFORNIA EMISSION PROCEDURES.

See knfilters.com for CARB status on each part for a specific vehicle

INSTALLATION INSTRUCTIONS

63-3088

CHEVROLET / GMC

2015 Colorado / Canyon

V6-3.6L

NOTE: This kit was not designed to fit vehicles with a body lift.

TOOLS NEEDED:

- ratchet
- extension
- 10mm socket
- 8mm socket
- T27 torx
- T20 torx
- flat blade screw driver
- 4mm allen
- 3mm allen
- 10mm wrench

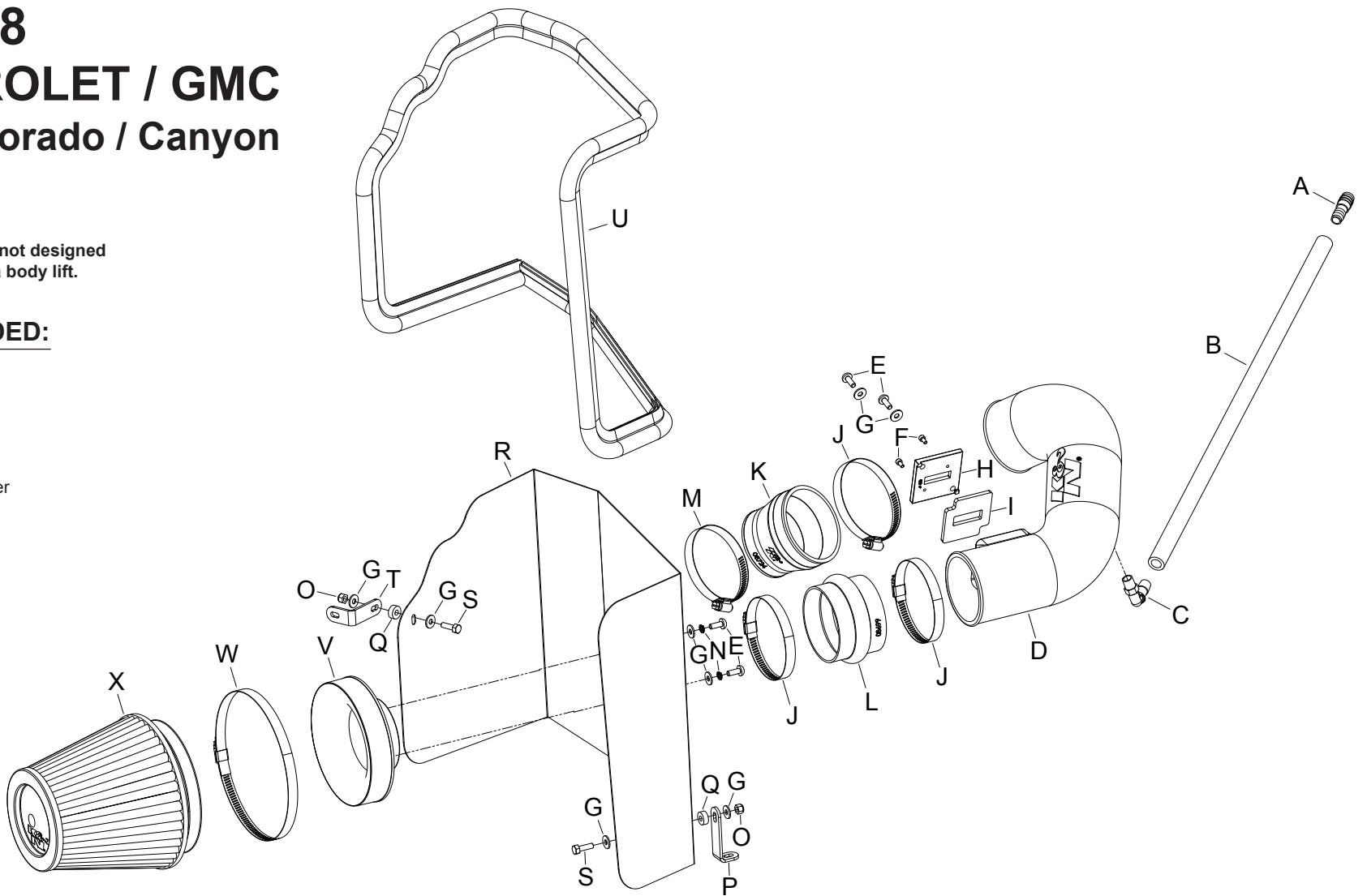

PARTS LIST:

Description	Qty.	Part #	Description	Qty.	Part #	Description	Qty.	Part #
A hose mender; 1/2" to 5/8", barbed	1	08726	I gasket; 57-2556, 3/16 poron	1	09069	Q spacer: .625" od x .250" id x .250" l	2	06555
B hose; 1/2" x 24" l	1	08642	J hose clamp #56	3	08620	R heat shield	1	073183
C vent; 90deg, 1/2" hose, 1/4" npt	1	08110FK	K hose; 3-1/2" to 3" id x 3" l tprd	1	08724	S bolt; m6 x 1.00" x 20mm hex, ss	2	07795
D intake tube	1	087293	L hose; 3-1/2" id x 2-1/2" l hump	1	08699	T bracket; 63-1025, small; tb/pc	1	070015
E bolt; m6 x 1.00 x 16mm, ss	4	07730	M hose clamp #52	1	08610	U edge trim (75")	1	102460
F bolt; m4 - 0.07 8mm, a/h cap, ss	2	07733	N washer, m6 split lock zinc	2	1-3025	V adapter; universal, 6" filter 3.5"	1	21512-1
G washer; 6mm flat, ss	8	08269	O nut; 6mm nylock, hexhead, ss	2	07512	W hose clamp # 104	1	08697
H adaptor; 57-2556, nylon 6/6 gf	1	21515	P bracket; "l", tb/pc	1	07805	X air filter	1	RF-1042XD

NOTE: FAILURE TO FOLLOW INSTALLATION INSTRUCTIONS AND NOT USING THE PROVIDED HARDWARE MAY DAMAGE THE INTAKE TUBE, THROTTLE BODY AND ENGINE.

TO START:

1. Turn off the ignition and disconnect the negative battery cable.
NOTE: Disconnecting the negative battery cable erases pre-programmed electronic memories. Write down all memory settings before disconnecting the negative battery cable. Some radios will require an anti-theft code to be entered after the battery is reconnected. The anti-theft code is typically supplied with your owner's manual. In the event your vehicles anti-theft code cannot be recovered, contact an authorized dealership to obtain your vehicles anti-theft code.

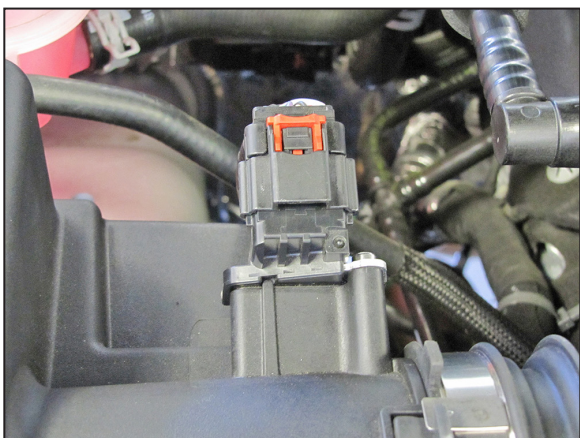

2. Disconnect the mass air sensor electrical connection.

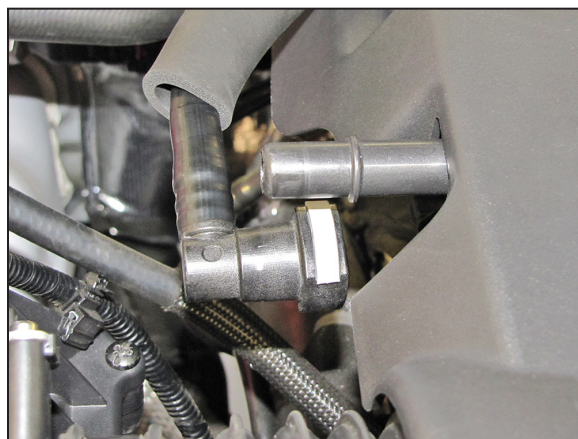

3. Disconnect the crank case vent hose from the intake plenum and then disconnect it from fitting on the valve cover.

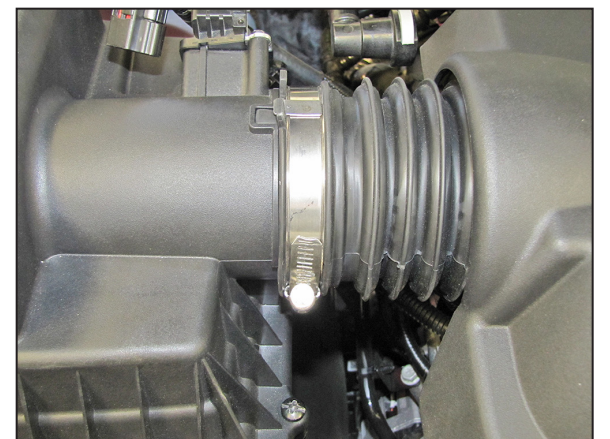

4. Loosen the hose clamp that secures the intake tube to the air filter housing.



5. Remove the oil cap.

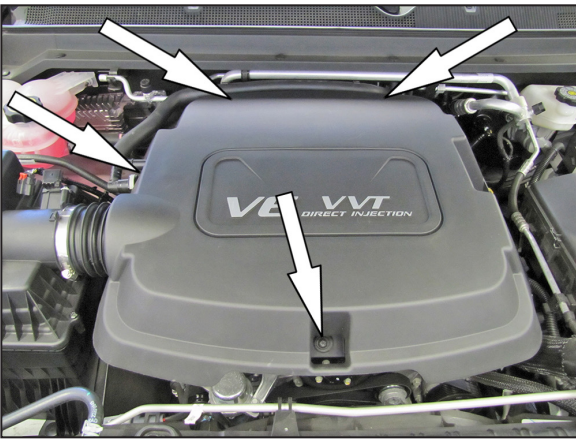

6. Loosen the two bolts that secure the rear of the intake plenum and remove the two forward bolts that secure the plenum.

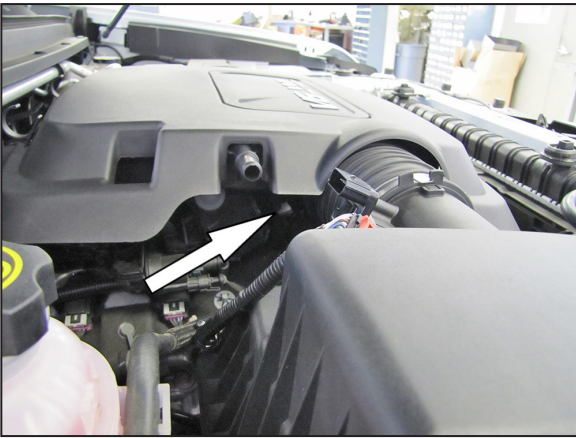

7. Loosen the hose clamp securing the intake plenum to the throttle body.



8. Lift up and remove the intake plenum from the engine.

NOTE: Be sure to reinstall the engine oil cap.

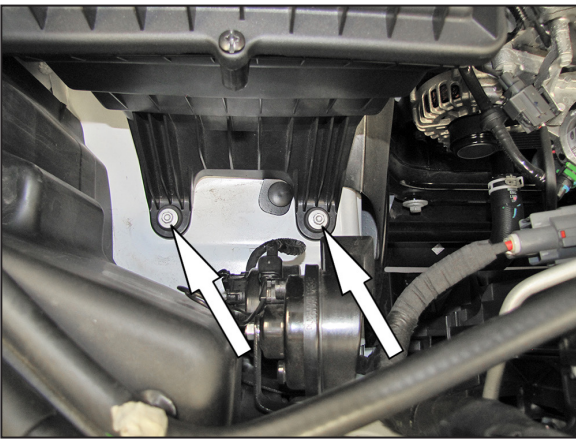

9. Remove the two nuts that secure the air filter housing to the inner fender and lift up the housing and remove it from the vehicle.

NOTE: The housing is also held by a mounting grommet in the rear. One of the air box mounting nuts will be reused in a later step. NOTE: K&N Engineering, Inc., recommends that customers do not discard factory air intake.

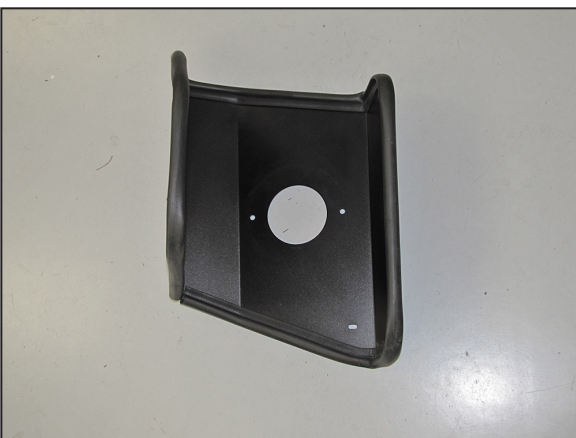

10. Install the provided edge trim onto the heat shield as shown.

NOTE: Some trimming of the edge trim will be necessary.

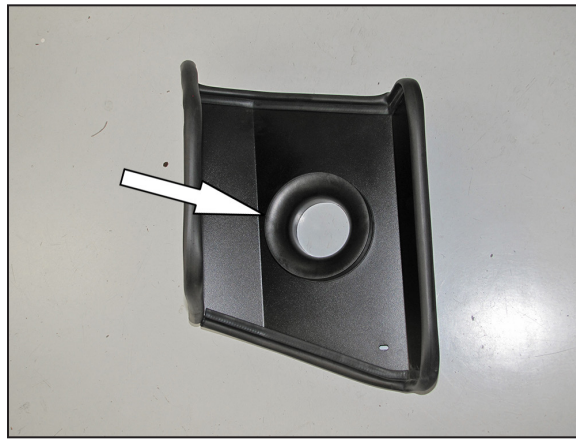

11. Install the provided filter adapter and secure with the provided hardware.



12. Install the provided heat shield mounting bracket (07805) onto the heat shield as shown using the provided hardware.

NOTE: be sure to place one of the provided spacers between the heat shield and bracket.

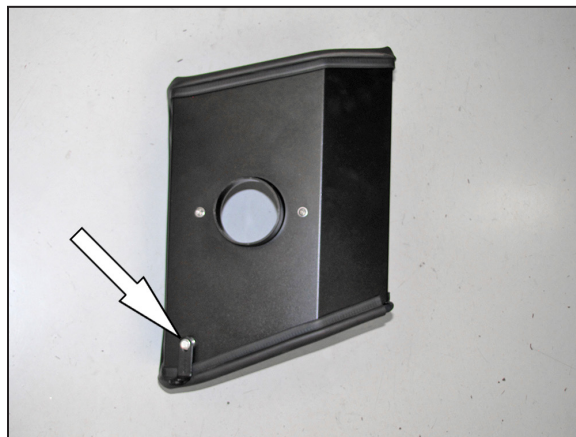

13. Install the provided heat shield mounting bracket (070015) onto the heat shield as shown using the provided hardware.

NOTE: be sure to place one of the provided spacers between the heat shield and bracket.

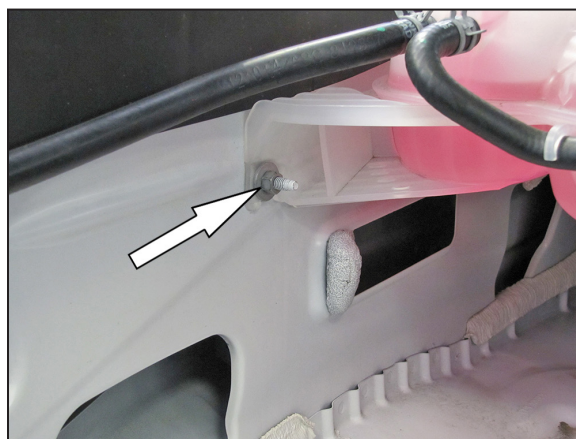

14. Remove the nut that secures the front of the coolant reservoir.

NOTE: This nut will be reused in the next step.



15. Install the heat shield so that the brackets set onto the coolant reservoir stud and the air filter housing mounting stud then secure the heat shield with the factory mounting nuts removed earlier.

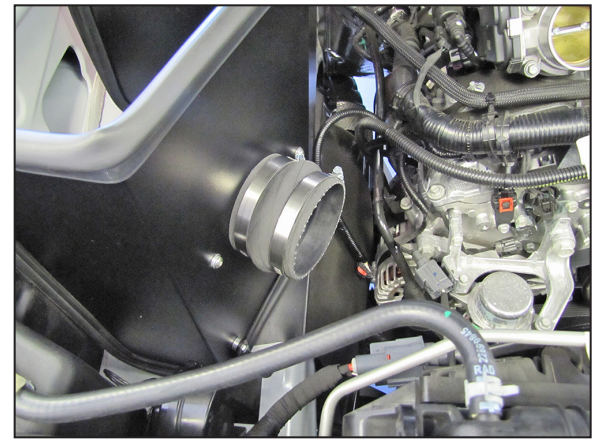

16. Install the provided hump coupler (06899) onto the filter adapter and secure with the provided hose clamp.



17. Install the provided step coupler (08724) onto the throttle body and secure with the provided hose clamp.

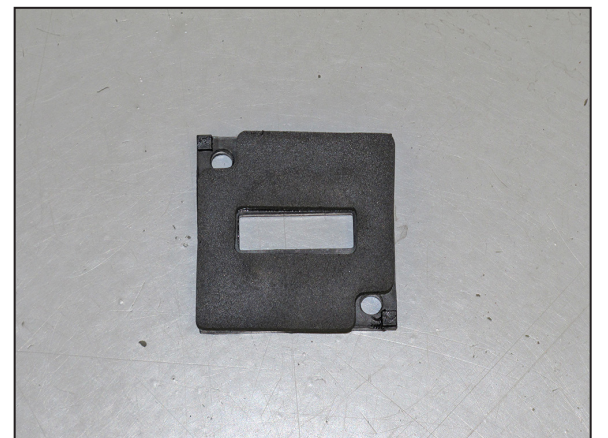

18. Install the provided gasket onto the K&N® mass air sensor adapter.

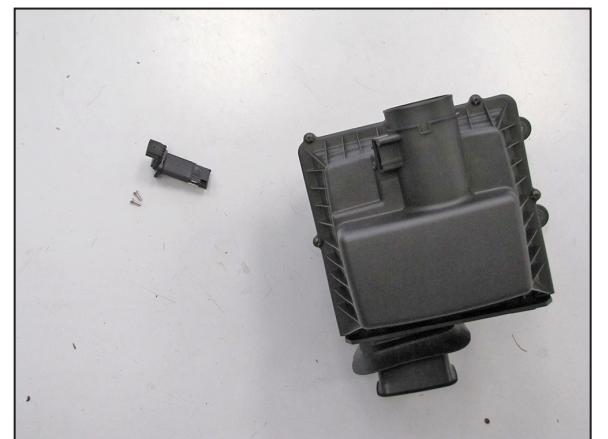

19. Remove the mass air sensor from the factory air filter housing.

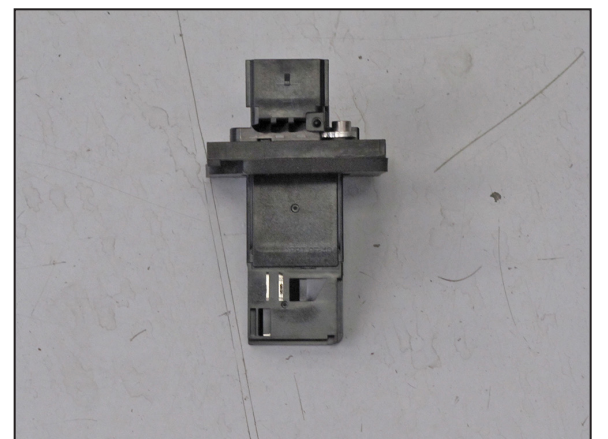

20. Install the factory mass air sensor into the K&N® adapter assemble and secure with the provided hardware.

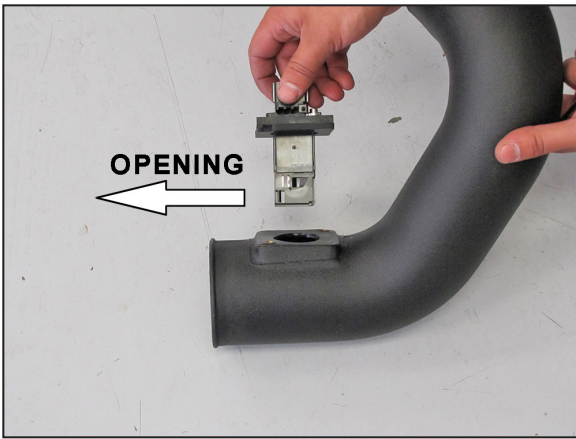

21. Install the mass air sensor assembly into the K&N® intake tube and secure with the provided hardware.

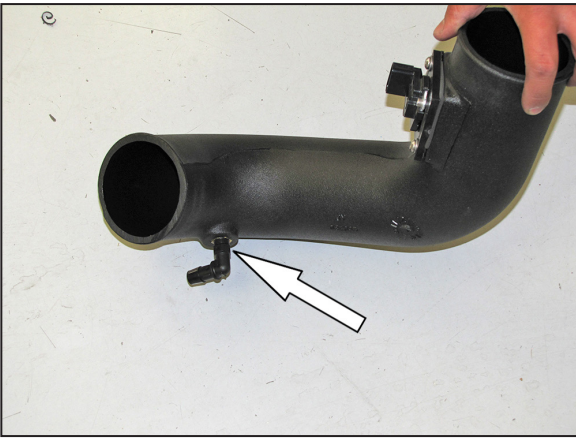

22. Install the provided 90° vent fitting into the K&N® intake tube as shown.
NOTE: Plastic NPT fittings are easy to cross thread. Install the vent fitting "hand" tight, then turn it two complete turns with a wrench.

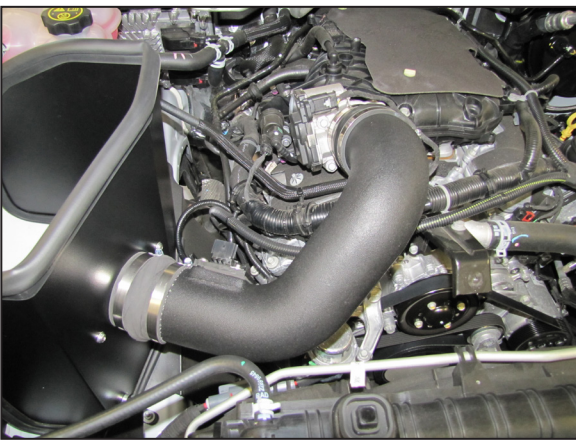

23. Install the K&N® intake tube into the hump coupler and then into the step coupler at the throttle body, adjust the tube for best fit and then secure with the provided hose clamps.

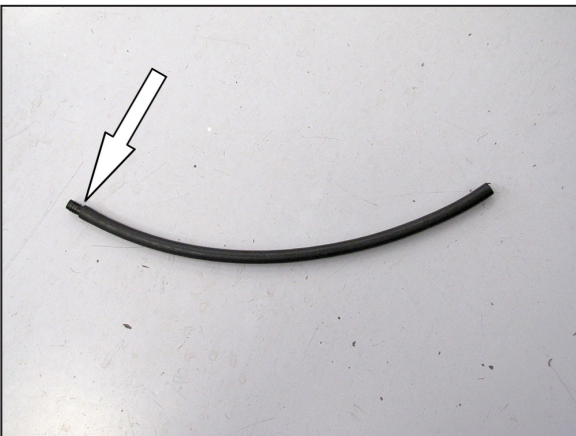

24. Install the hose mender into the provided crank case vent hose.



25. Install the crank case vent hose onto the fitting installed into the K&N® intake tube and then connect the hose mender into the fitting on the valve cover.

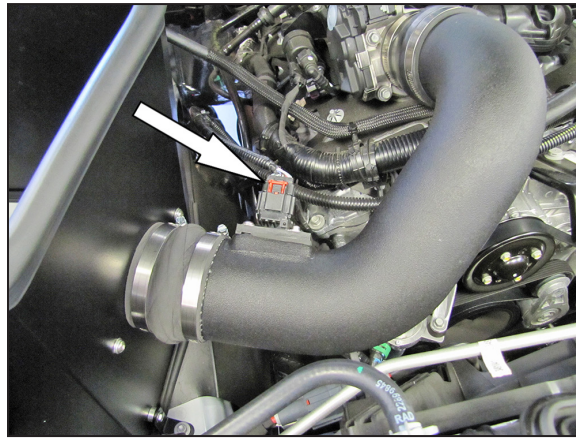

26. Reconnect the mass air sensor electrical connection.

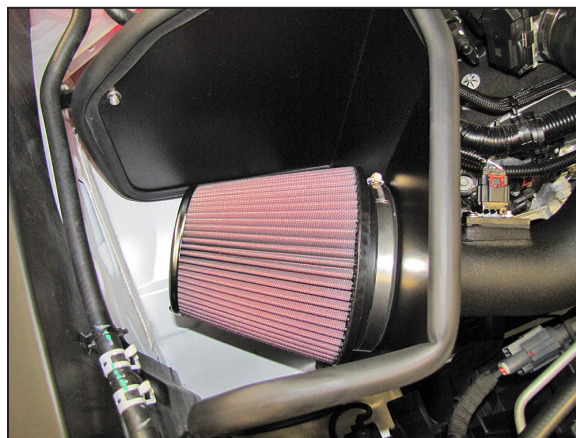

27. Install the K&N® air filter and secure with the provided hose clamp.
NOTE: Drycharger® air filter wrap; part # RF-1042DK is available to purchase separately. To learn more about Drycharger® filter wraps or look up color availability please visit <http://www.knfilters.com>®.



28. Reconnect the vehicle's negative battery cable. Double check to make sure everything is tight and properly positioned before starting the vehicle.

29. It will be necessary for all K&N® high flow intake systems to be checked periodically for realignment, clearance and tightening of all connections. Failure to follow the above instructions or proper maintenance may void warranty.

ROAD TESTING:

1. Start the engine with the transmission in neutral or park, and the parking brake engaged. Listen for air leaks or odd noises. For air leaks secure hoses and connections. For odd noises, find cause and repair before proceeding. This kit will function identically to the factory system except for being louder and much more responsive.

2. Test drive the vehicle. Listen for odd noises or rattles and fix as necessary.

3. If road test is fine, you can now enjoy the added power and performance from your kit.

4. K&N Engineering, Inc., requires cleaning the intake system's air filter element every 100,000 miles. When used in dusty or off-road environments, our filters will require cleaning more often. We recommend that you visually inspect your filter once every 25,000 miles to determine if the screen is still visible. When the screen is no longer visible some place on the filter element, it is time to clean it. To clean and re-oil, purchase our filter Recharger® service kit, part number 99-5050 or 99-5000 and follow the easy instructions.

NOT LEGAL FOR SALE OR USE ON ANY POLLUTION CONTROLLED MOTOR VEHICLE IN CALIFORNIA OR STATES ADOPTING CALIFORNIA EMISSION PROCEDURES.

See knfilters.com for CARB status on each part for a specific vehicle