



# AIRCHARGER™

## HIGH-FLOW INTAKE KITS

NOT LEGAL FOR SALE OR USE ON ANY POLLUTION CONTROLLED MOTOR VEHICLE IN CALIFORNIA OR STATES ADOPTING CALIFORNIA EMISSION PROCEDURES.  
See knfilters.com for CARB status on each part for a specific vehicle

### INSTALLATION INSTRUCTIONS

## 63-2582

## FORD

### 2011-15 F250 / F350 / F450 / F550

### V8-6.7L Turbo Diesel

**NOTE:** This kit was not designed to fit vehicles with a body lift.

#### TOOLS NEEDED:

- Ratchet
- Extension
- 13mm Socket
- 10mm Socket
- 8mm Socket
- 7/32" Socket
- Flat Blade Screwdriver
- Pliers
- T20 Torx
- 13mm Wrench
- 10mm Wrench
- 4mm Allen Wrench
- 3mm Allen Wrench

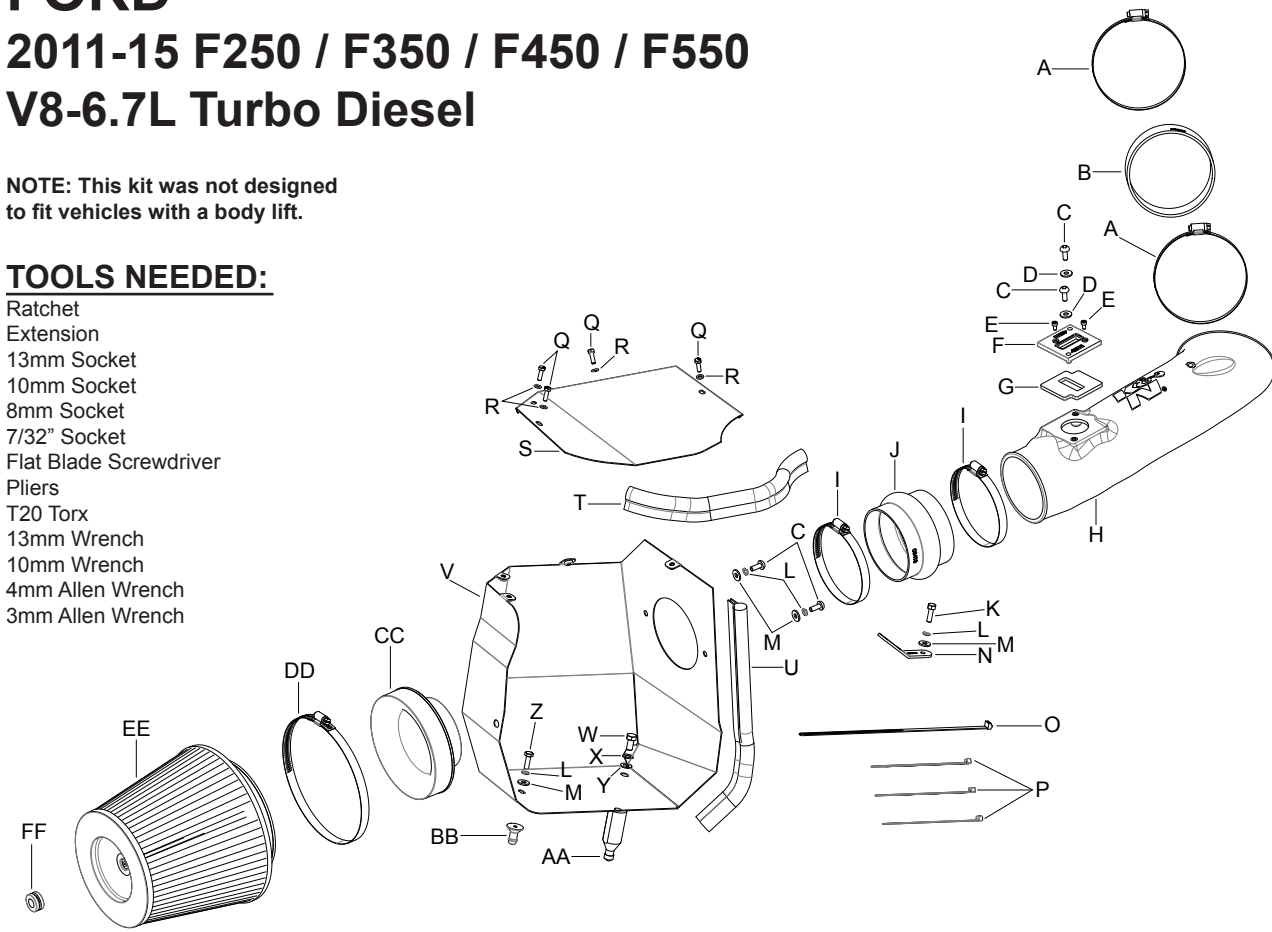

#### PARTS LIST:

Description	Qty.	Part #
A	Hose Clamp # 72	2 08671
B	Hose; 4-1/2" ID X 1-3/4"L Reinforced	1 08540
C	Bolt; M6 X 1.00 X 16MM, Buttonhead, SS	4 07730
D	Washer; 6MM Flat, SS	2 08269
E	Bolt; M4-0.07 8MM, A/H Cap, SS	2 07733
F	Adaptor; Nylon 6/6 GF, Black	1 21515
G	Gasket; 3/16 Poron	1 09069
H	Intake Tube	1 087252
I	Hose Clamp # 64 Stainless	2 08645
J	Hose; 4" ID X 3"L Hump Reinforced	1 08418
K	Bolt; M6 X 1.00" X 20MM HEX, SS	1 07795
L	Washer, M6 Split Lock Zinc	4 1-3025
M	Washer; 1/4" ID X 5/8" OD -SAE	4 08275
N	Bracket; "L", STL, TK/PC	1 083155
O	Cable Ties; 11" Black	1 21590
P	Zip Tie, 8" Tree Push-MNT	3 1-127
Q	Bolt; 5MM-.80 X 16MM Hexhead	4 22204
R	Washer; 5MM Internal Star Cut Lock	4 07724
S	Heat Shield Lid	1 074090
T	Edge Trim (11")	1 102468
U	Edge Trim (15")	1 102474
V	Heat Shield	1 074091
W	Bolt; 8MM-1.25 X 16MM, Hexhead	1 07844
X	Washer; 8MM Spring (Wave)	1 08239
Y	Washer; 5/16" ID X 5/8" OD, Flat	1 08276
Z	Bolt; 6MM- 1.00 X 16MM, SS	1 07812
AA	Standoff; 6.0 Ford Air box	1 06532
BB	Nipple, Heatshield Mount Pres.	1 8-186
CC	Adaptor; #454	1 27300
DD	Hose Clamp # 104	1 08697
EE	Air Filter	1 RC-5282
FF	Grommet; 1"OD, 1/2"ID, 1/2" THK	1 08064

**NOTE: FAILURE TO FOLLOW INSTALLATION INSTRUCTIONS AND NOT USING THE PROVIDED HARDWARE MAY DAMAGE THE INTAKE TUBE, THROTTLE BODY AND ENGINE.**

#### TO START:

- Turn off the ignition and disconnect the negative battery cable.  
**NOTE:** Disconnecting the negative battery cable erases pre-programmed electronic memories. Write down all memory settings before disconnecting the negative battery cable. Some radios will require an anti-theft code to be entered after the battery is reconnected. The anti-theft code is typically supplied with your owner's manual. In the event your vehicles' anti-theft code cannot be recovered, contact an authorized dealership to obtain your vehicles anti-theft code.

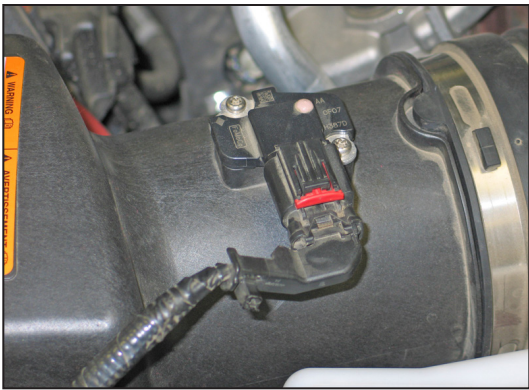

- Release the red locking tab and then disconnect the mass air sensor electrical connection and unhook the wiring harness from the air box.

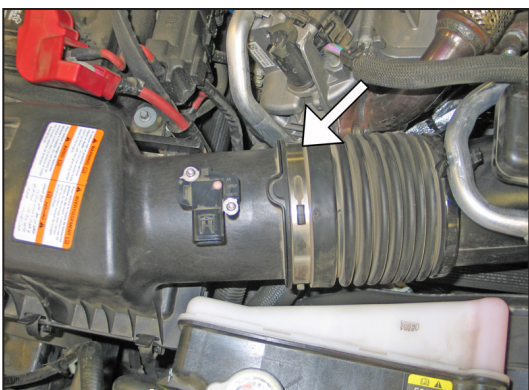

- Loosen the hose clamp that secures the intake tube to the upper air box.

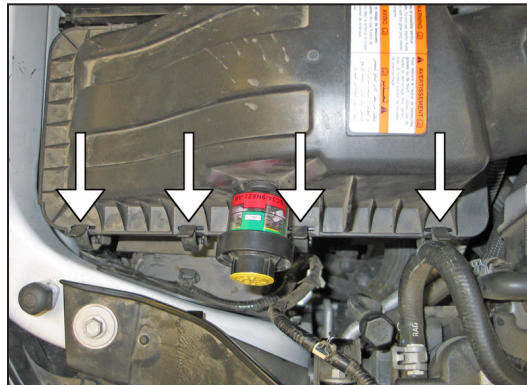

- Release the four upper air box retaining clips.



- Remove the upper air box housing from the vehicle.

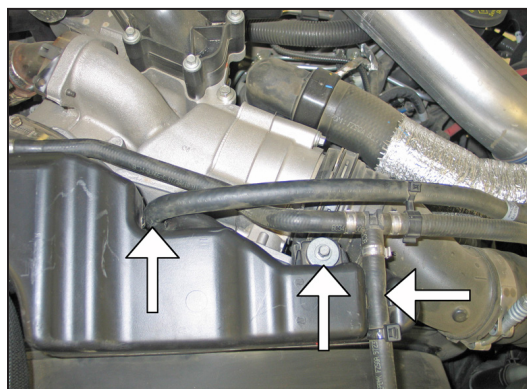

- Unhook the coolant hoses from the intake plenum and remove the bolt securing the plenum to the engine fan shroud.

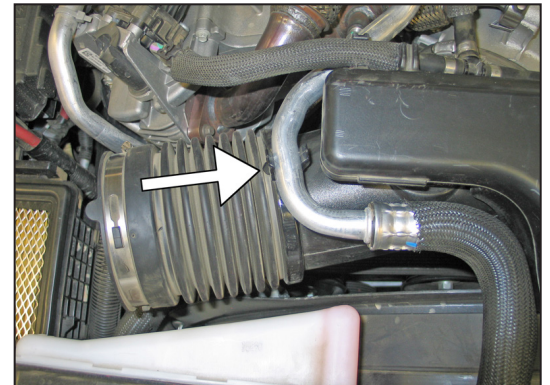

- Unhook the coolant pipe from the intake tube.

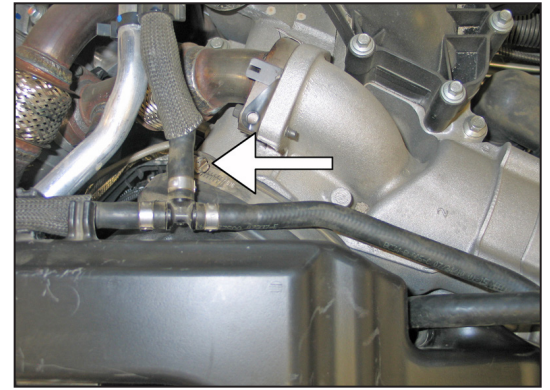

- Loosen the hose clamp that secures the intake tube to the engine inlet.

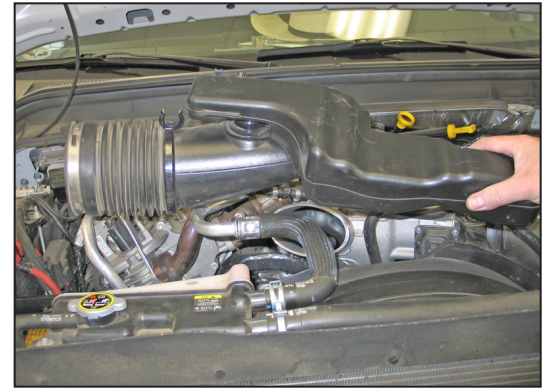

- Remove the intake tube from the vehicle.





10. Remove the bolt securing the lower air box to the battery tray.



11. Remove the lower air box from the vehicle.  
**NOTE: K&N Engineering, Inc., recommends that customers do not discard factory air intake.**

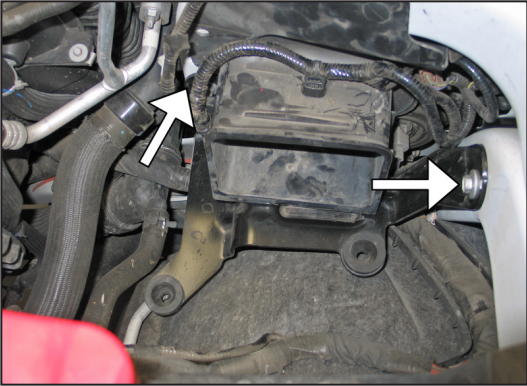

12. Remove the two bolts that secure the air box mounting bracket to the core support and inner fender.



13. Remove the air box mounting bracket from the vehicle.

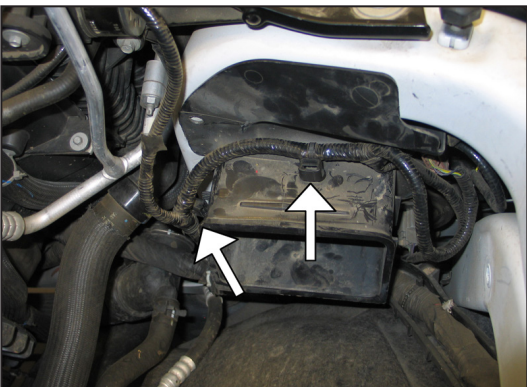

14. Unhook the wiring harness from the fresh air intake duct.



15. Remove the 5 bolts and one push pin securing the front of the inner fender panel and then pull the inner fender panel back to gain access to the bottom of the fresh air intake duct.

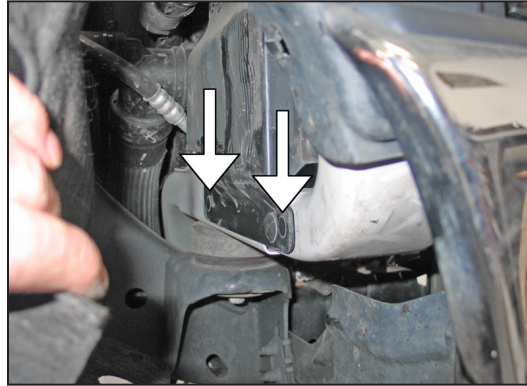

16. Remove the two clips shown that retain the bottom of the fresh air intake duct.



17. Remove the push pin securing the top of the fresh air intake duct.

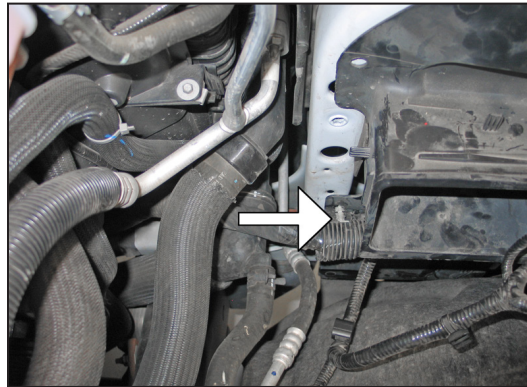

18. Unhook the wiring harness secured to the core support through the fresh air intake duct.



19. Remove the fresh air intake duct from the vehicle. Secure the inner fender to the vehicle with the original hardware from step #15.

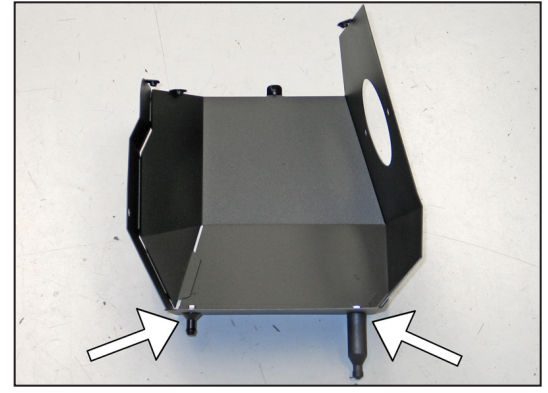

20. Install the two heat shield stand-offs onto the heat shield as shown using the provided hardware.

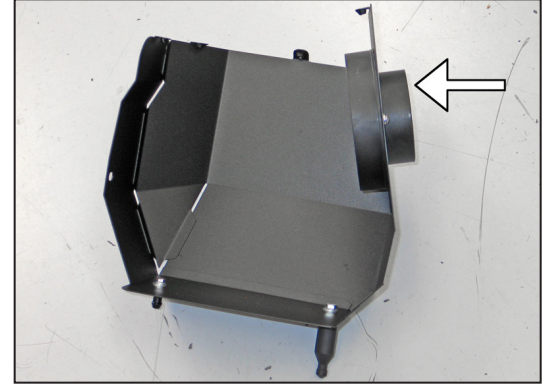

21. Install the filter adapter into the heat shield using the provided hardware.

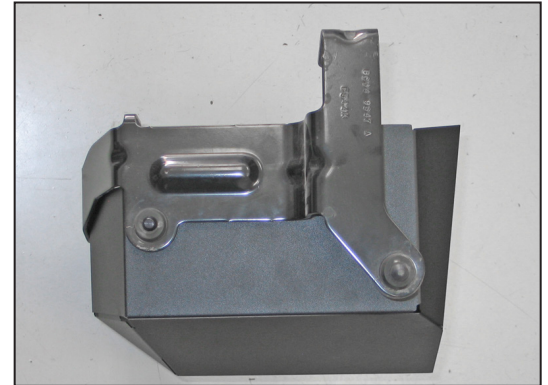

22. Install the factory air box mounting bracket onto the heat shield as shown so that the mount stand-offs installed in step #20 snap into the factory mounting grommets.

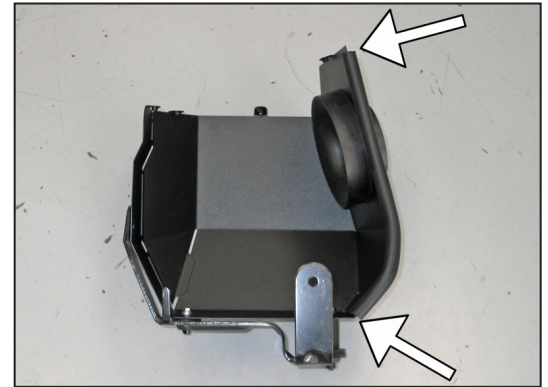

23. Install the provided edge trim onto the heat shield as shown.

**NOTE: Some trimming of the edge trim will be necessary.**



24. Set the heat shield assembly into position and secure with the factory mounting hardware from step #12.

**NOTE: Start the bolt going into the inner fender panel first, then start the bolt going into the core support; once both are installed, tighten both bolts. Use care lowering the heat shield into position as it will be very close to the positive battery cable. The negative battery cable should have been disconnected in step #1 to prevent any possible arcing.**



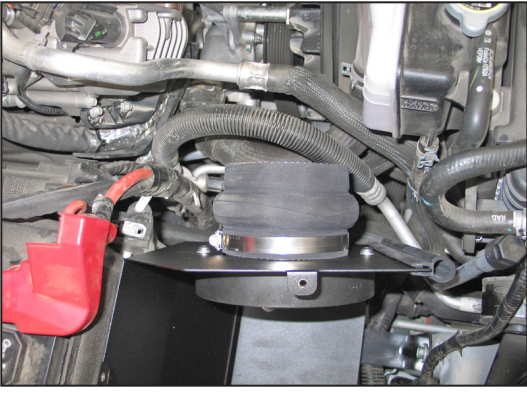

25. Install the silicone hump hose (08418) onto the filter adapter and secure with the provided hose clamp.

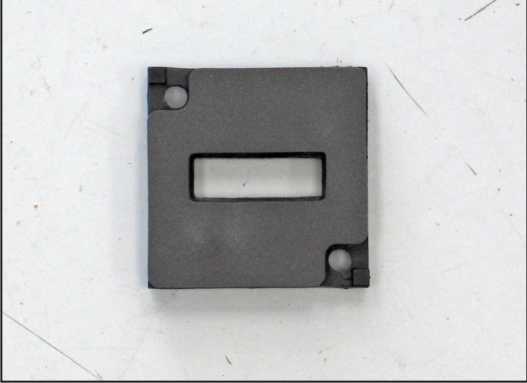

26. Attach the provided gasket onto the mass air sensor adapter as shown.



27. Remove the two screws securing the mass air sensor into the factory air box and then remove the sensor from the air box.

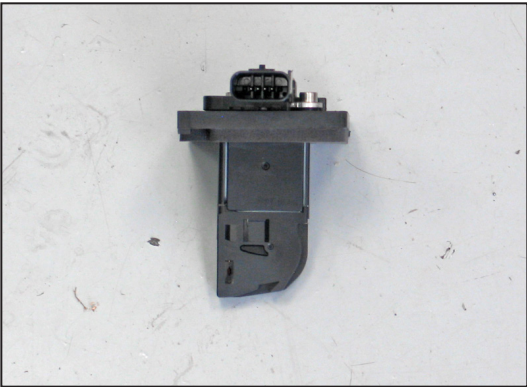

28. Install the mass air sensor into the K&N® mass air sensor adapter and secure with the provided hardware.

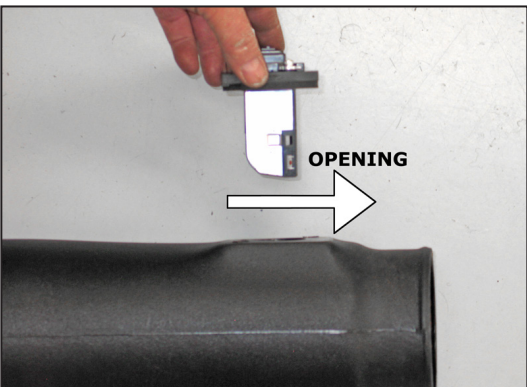

29. Install the mass air sensor assembly into the K&N® intake tube as shown and secure with the provided hardware.  
**NOTE: The opening in the front of the sensor should be pointed towards the filter end of the tube.**



30. Install the provided silicone hose (08540) all the way onto the K&N® intake tube so the end of the tube is exposed.



31. Install the intake tube into the silicone hose attached to the filter adapter and align the tube with the factory intake. Slide the silicone hose onto the factory intake and then secure the tube with the hose clamps.

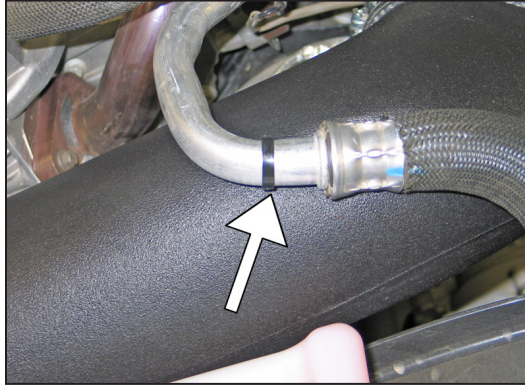

32. Secure the coolant pipe to the insert of the K&N® intake tube with the provided mounting tie wrap.



33. Install the coolant hose bracket onto the fan shroud as shown using the provided hardware.

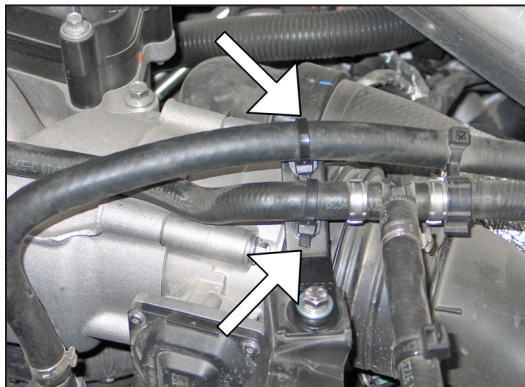

34. Secure the two coolant hoses with the provided mounting tie wraps as shown.

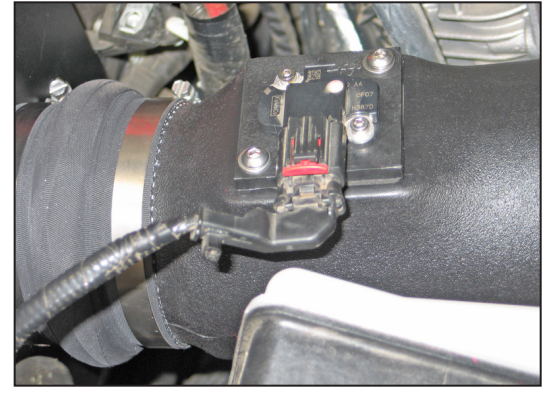

35. Reconnect the mass air sensor electrical connection. Secure the mass air sensor wiring harness to the A/C recharge pipe with the provided tie wrap.



36. Remove the filter minder from the factory upper air box.



37. Install the filter minder along with the provided grommet into the K&N® air filter as shown.



38. Feed the K&N® air filter top first into its location, then rotate it back and install onto the filter adapter. Secure the air filter with the provided hose clamp.

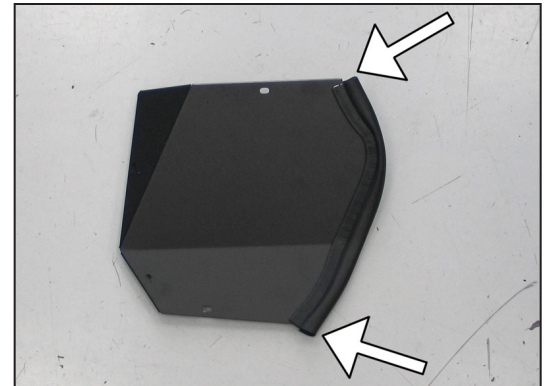

39. Install the provided edge trim onto the heat shield lid as shown.  
**NOTE: Some trimming of the edge trim will be necessary.**





40. Attach the heat shield lid onto the heat shield and secure with the provided hardware.

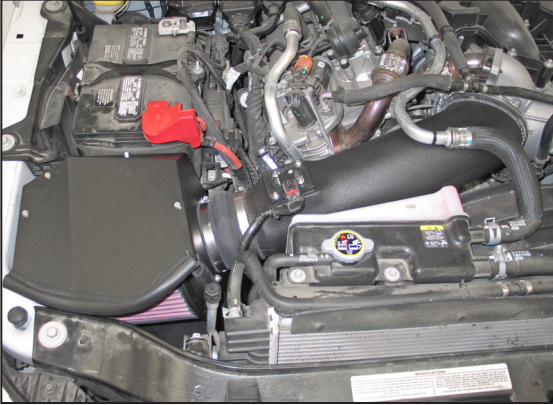

41. Reconnect the vehicle's negative battery cable. Double check to make sure everything is tight and properly positioned before starting the vehicle.

42. It will be necessary for all K&N® high flow intake systems to be checked periodically for realignment, clearance and tightening of all connections. Failure to follow the above instructions or proper maintenance may void warranty.

#### ROAD TESTING:

1. Start the engine with the transmission in neutral or park, and the parking brake engaged. Listen for air leaks or odd noises. For air leaks secure hoses and connections. For odd noises, find cause and repair before proceeding. This kit will function identically to the factory system except for being louder and much more responsive.

2. Test drive the vehicle. Listen for odd noises or rattles and fix as necessary.

3. If road test is fine, you can now enjoy the added power and performance from your kit.

4. K&N Engineering, Inc., requires cleaning the intake system's air filter element every 100,000 miles. When used in dusty or off-road environments, our filters will require cleaning more often. We recommend that you visually inspect your filter once every 25,000 miles to determine if the screen is still visible. When the screen is no longer visible some place on the filter element, it is time to clean it. To clean and re-oil, purchase our filter Recharger® service kit, part number 99-5050 or 99-5000 and follow the easy instructions.

**NOT LEGAL FOR SALE OR USE ON ANY POLLUTION CONTROLLED MOTOR VEHICLE IN CALIFORNIA OR STATES ADOPTING CALIFORNIA EMISSION PROCEDURES.**

See [knfilters.com](http://knfilters.com) for CARB status on each part for a specific vehicle