



AIRCHARGER®

HIGH-FLOW INTAKE KITS

NOT LEGAL FOR SALE OR USE ON ANY POLLUTION CONTROLLED MOTOR VEHICLE IN CALIFORNIA OR STATES ADOPTING CALIFORNIA EMISSION PROCEDURES.

See knfilters.com for CARB status on each part for a specific vehicle

INSTALLATION INSTRUCTIONS

63-2565

FORD

2007-09 Mustang GT

V8-4.6L

TOOLS NEEDED:

- Flat Blade Screwdriver
- Ratchet
- Extension
- 8mm Socket
- 10mm Socket
- 10mm Wrench
- 4mm Allen Wrench
- 2.5mm Allen Wrench
- Needle Nose Pliers

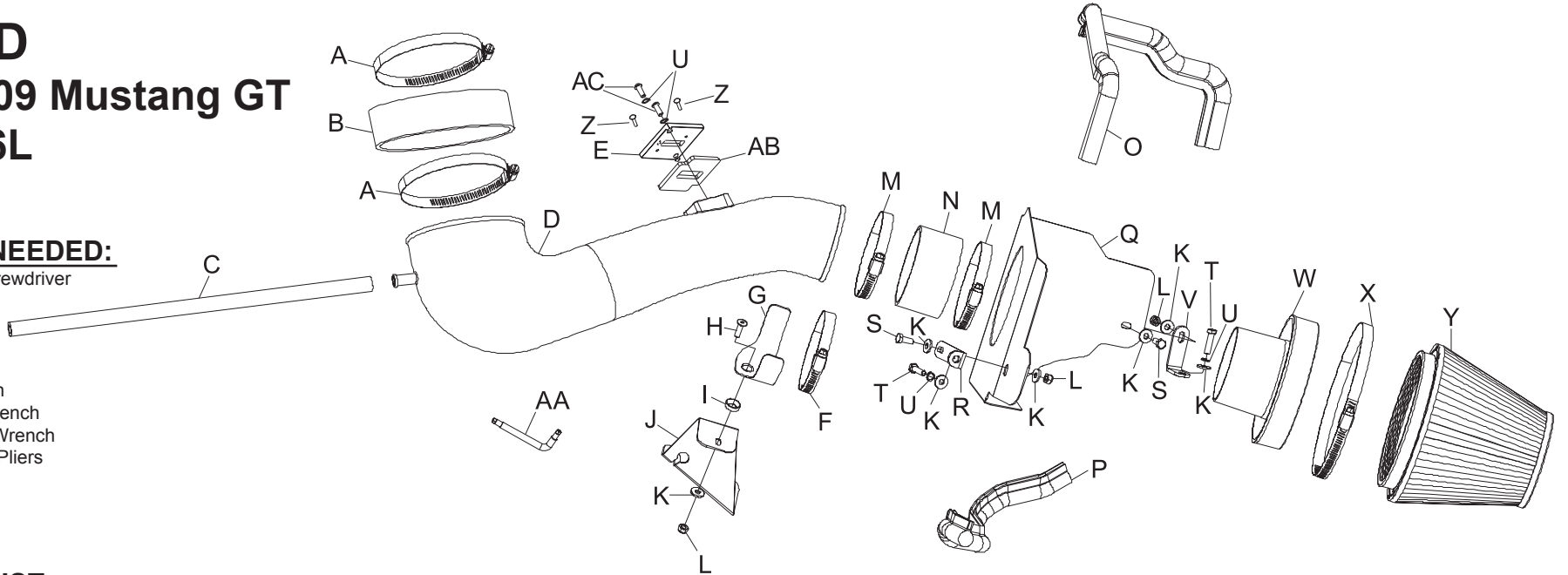

PARTS LIST:

Description	Qty.	Part #
A Hose Clamp #72	2	08671
B Hose; 2"ID x 6.13"ID Oval	1	08541
C Hose; 3/8"ID x 17"L	1	08404
D Intake Tube (EW)	1	087166-1
E Adaptor; Nylon 6/6 GF, Black	1	21515
F Hose Clamp #52	1	08610
G Saddle Bracket	1	078855
H Bolt; 6mm-1.00 x 20mm, F/H/A	1	08376
I Washer, Conical, Black Nylon	1	08180
J Bracket	1	26638
K Washer; 1/4"ID x 5/8"OD Flat	7	08275
L Nut; 6mm Nylock	3	07553
M Hose Clamp #56	2	08620
N Hose; 3.5"ID x 2"L, Black Silicone	1	08630
O Edge Trim 30"	1	102489
P Edge Trim 23"	1	102495
Q Heat Shield	1	074038
R Bracket; "L"	1	07158
S Bolt; 6mm-1.00 x 16mm, Hex	2	07703
T Bolt; 6mm-1.00 x 25mm, Hex	2	07704
U Washer; 1/4" Split Lock	4	08198
V Bracket "L"	1	070812
W Adapter #452	1	21518
X Hose Clamp #104	1	08697
Y Air Filter	1	RF-1048
Z Screw; m4.7x16mm	2	07726
AA Wrench; Torx T20	1	69801
AB Gasket; 3/16 Poron	1	09069
AC Bolt; M6x1.00x16mm, BH, SS	2	07730

NOTE: FAILURE TO FOLLOW INSTALLATION INSTRUCTIONS AND NOT USING THE PROVIDED HARDWARE MAY DAMAGE THE INTAKE TUBE, THROTTLE BODY AND ENGINE.

TO START:

1. Turn off the ignition and disconnect the negative battery cable.

NOTE: Disconnecting the negative battery cable erases pre-programmed electronic memories. Write down all memory settings before disconnecting the negative battery cable. Some radios will require an anti-theft code to be entered after the battery is reconnected. The anti-theft code is typically supplied with your owner's manual. In the event your vehicles' anti-theft code cannot be recovered, contact an authorized dealership to obtain your vehicles anti-theft code.

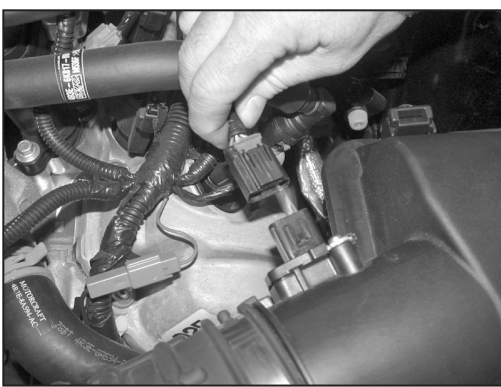

2. Release the red locking tab and then disconnect the mass air sensor electrical connection.



3. Rotate the green locking tab clockwise and then disconnect the crank case breather hose from the valve cover as shown.



4. Loosen the hose clamps, which secure the intake tube to the throttle body and air box, then remove the intake tube as shown.

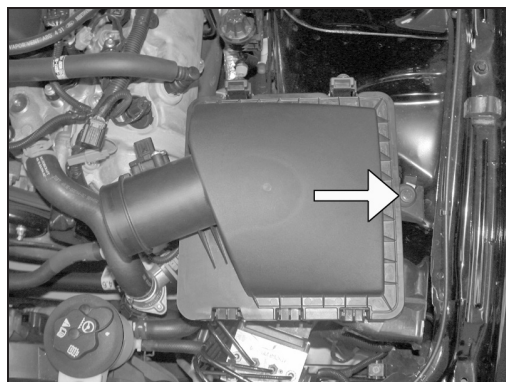

5. Remove the air box mounting bolt shown.



6. Remove the air box assembly as shown. **NOTE: K&N Engineering, Inc., recommends that customers do not discard factory air intake.**

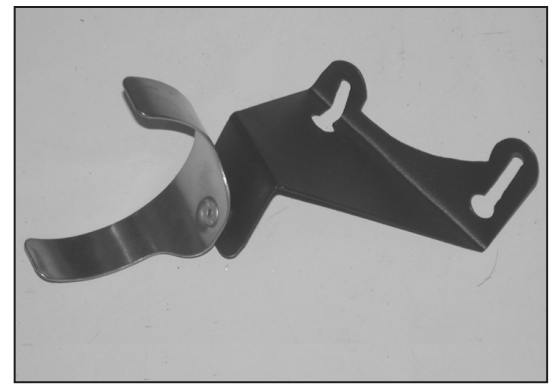

7. Install the saddle clamp onto the tubemounting bracket as shown with the provided hardware.

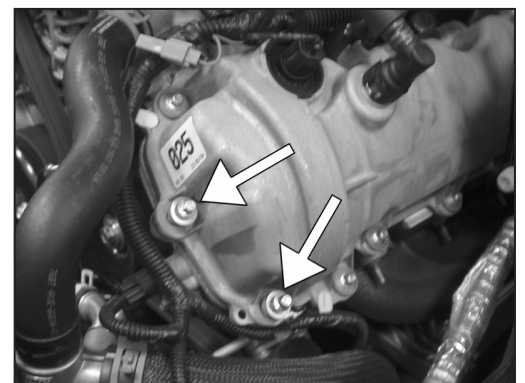

8. Remove the two valve cover bolts shown. **NOTE: These bolts will be reused.**

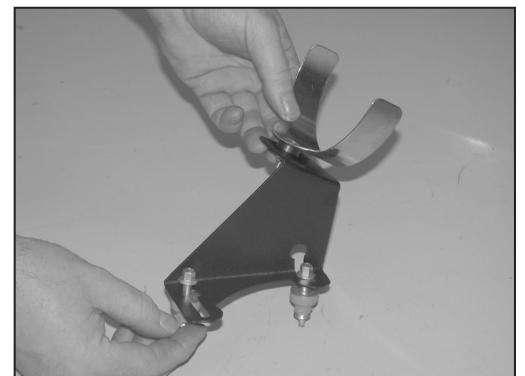

9. Install the valve cover bolts removed in step #8 into the tube mounting bracket as shown passing through the key hole portion and then slide the bolts to the end of the slots.

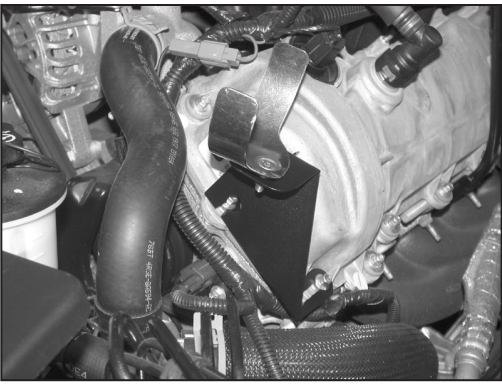

10. Install the tube-mounting bracket onto the valve cover as shown and secure with the stock hardware removed in step #8.

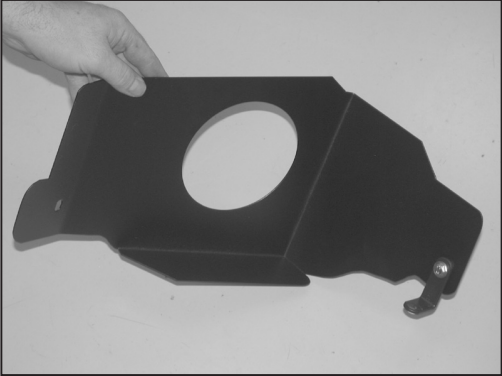

11. Install the "L" bracket (070812) onto the rear of the heat shield as shown with the provided hardware.

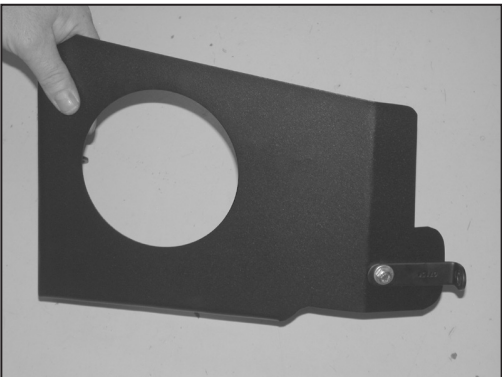

12. Install the "L" bracket (07158) onto the front of the heat shield as shown with the provided hardware.

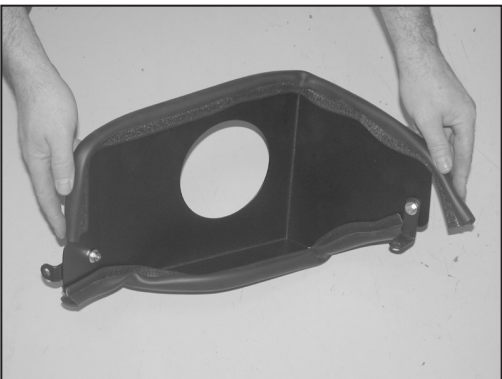

13. Install the edge trim onto the heat shield as shown.

NOTE: Some trimming of the edge trim may be necessary for proper fit.

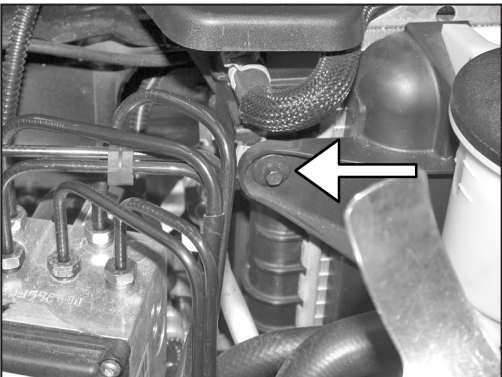

14. Remove the radiator fan shroud mounting bolt shown.

NOTE: This bolt will not be reused.

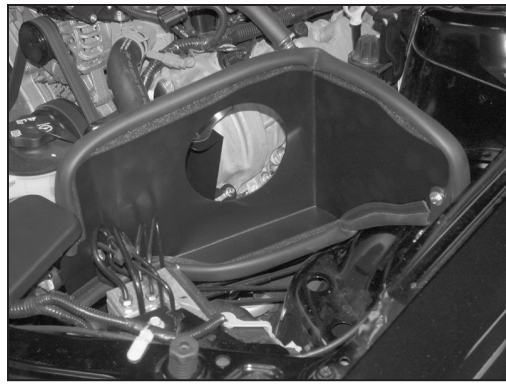

15. Install the heat shield and secure with the provided hardware as shown.

NOTE: The forward mounting bracket will mount to the radiator fan shroud mounting location and the rear bracket will mount to the air box mounting location.

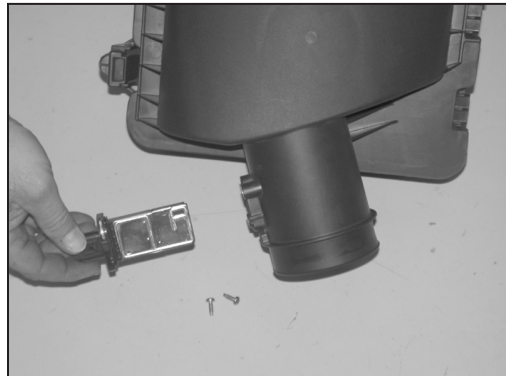

16. Remove the mass air sensor from the factory air box with the T20 "TORX" wrench provided.

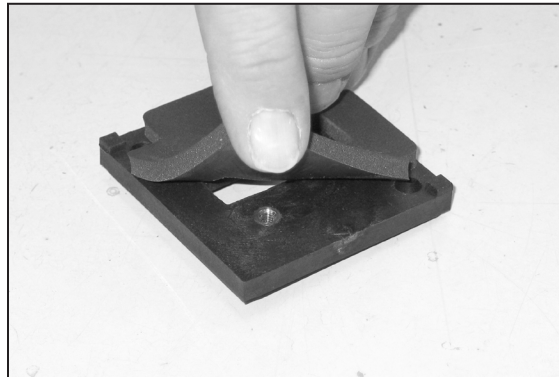

17. Install the provided gasket to the back of the K&N® mass air sensor adaptor plate as shown.

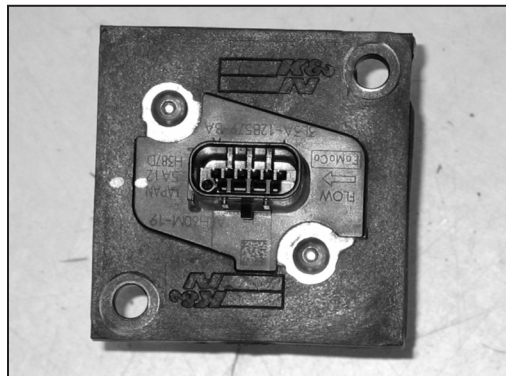

17a. Install the mass air sensor into the K&N® mass air sensor adaptor and secure with the provided hardware.



17b. Install the mass air sensor assembly into the K&N® intake tube and secure with the provided hardware.

NOTE: Be sure the opening in the mass air sensor is towards the inlet end of the tube.

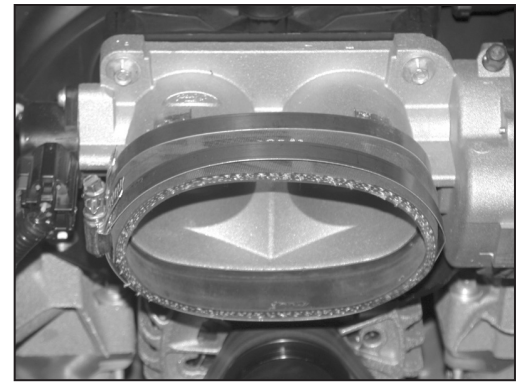

18. Install the silicone hose (08541) onto the throttle body with the provided hose clamps as shown.



19. Install the K&N® intake tube into the silicone hose at the throttle body and onto the saddle bracket assembly then secure with the provided hose clamps as shown.



20. Install the supplied vent hose onto the vent port on the valve cover and then onto the K&N® intake tube as shown.

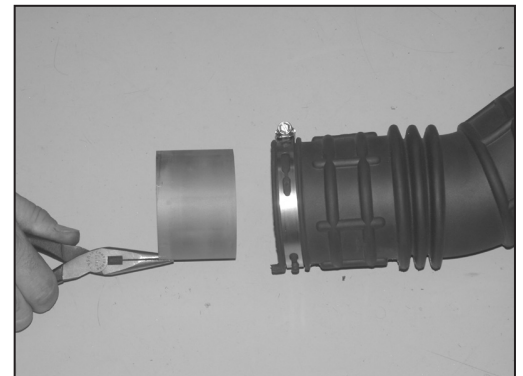

21. Vehicles that come equipped with Hydrocarbon trap, use a pair of needle nose pliers, to remove the Hydrocarbon trap from the stock intake tube as shown.

NOTE: The Hydrocarbon trap coating is very fragile; care should be taken during removal as not to damage it.

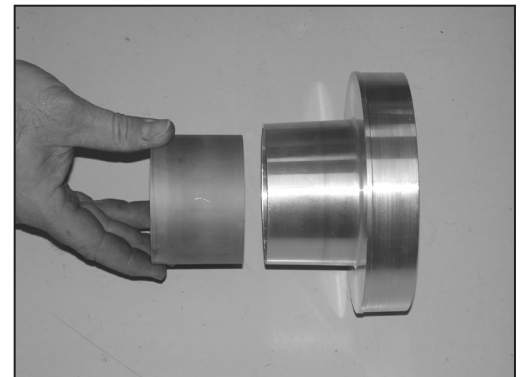

22. Vehicles that come equipped with Hydrocarbon trap, place the Hydrocarbon trap into the filter adapter as shown.

NOTE: This intake system is designed to use the factory Hydrocarbon trap, Failure to use the Hydrocarbon trap will result in poor performance and possible engine damage may result.



23. Install the silicone hose (08630) onto the filter adapter and secure with the provided hose clamp as shown.



24. Install the air filter onto the air filter adapter and secure with the provided hose clamp as shown.

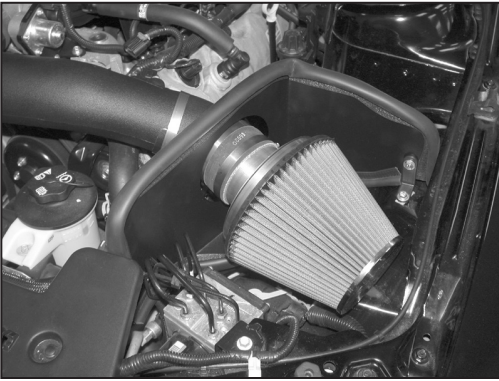

25. Install the air filter assembly onto the K&N® intake tube as shown and secure with the provided hose clamp.



26. Reconnect the mass air sensor electrical connection as shown.



27. Reconnect the vehicle's negative battery cable. Double check to make sure everything is tight and properly positioned before starting the vehicle.

28. It will be necessary for all K&N® high flow intake systems to be checked periodically for realignment, clearance and tightening of all connections. Failure to follow the above instructions or proper maintenance may void warranty.

ROAD TESTING:

1. Start the engine with the transmission in neutral or park, and the parking brake engaged. Listen for air leaks or odd noises. For air leaks secure hoses and connections. For odd noises, find cause and repair before proceeding. This kit will function identically to the factory system except for being louder and much more responsive.

2. Test drive the vehicle. Listen for odd noises or rattles and fix as necessary.

3. If road test is fine, you can now enjoy the added power and performance from your kit.

4. K&N Engineering, Inc., requires cleaning the intake system's air filter element every 100,000 miles. When used in dusty or off-road environments, our filters will require cleaning more often. We recommend that you visually inspect your filter once every 25,000 miles to determine if the screen is still visible. When the screen is no longer visible some place on the filter element, it is time to clean it. To clean and re-oil, purchase our filter Recharger® service kit, part number 99-5050 or 99-5000 and follow the easy instructions.

NOT LEGAL FOR SALE OR USE ON ANY POLLUTION CONTROLLED MOTOR VEHICLE IN CALIFORNIA OR STATES ADOPTING CALIFORNIA EMISSION PROCEDURES.

See knfilters.com for CARB status on each part for a specific vehicle