



# AIRCHARGER®

## HIGH-FLOW INTAKE KITS

NOT LEGAL FOR SALE OR USE ON ANY POLLUTION CONTROLLED MOTOR VEHICLE IN CALIFORNIA OR STATES ADOPTING CALIFORNIA EMISSION PROCEDURES.  
See knfilters.com for CARB status on each part for a specific vehicle.

### INSTALLATION INSTRUCTIONS

**63-1569**  
**JEEP**  
**2014-15 Cherokee**  
**V6-3.2L**

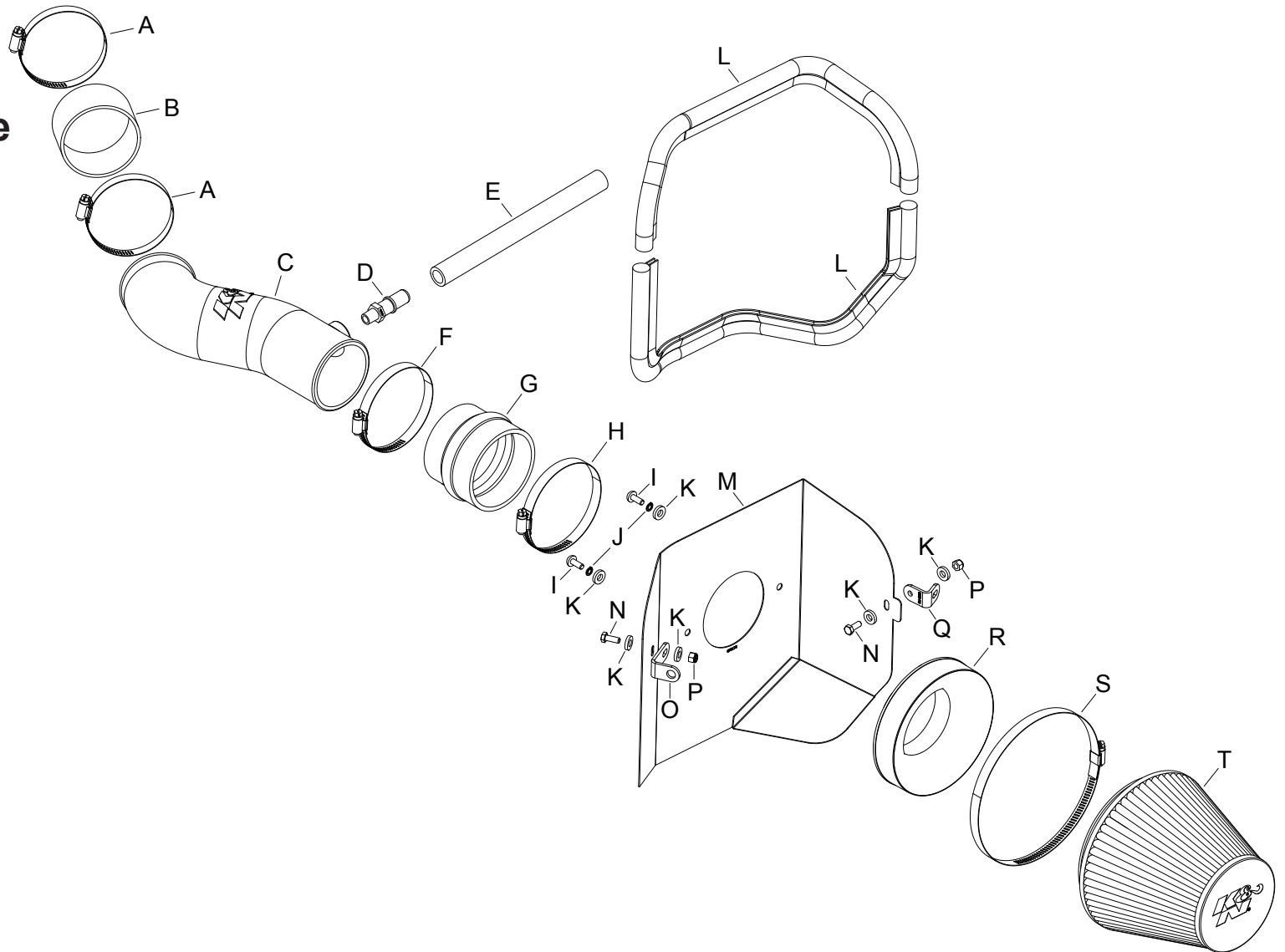

**TOOLS NEEDED:**

- ratchet
- extension
- 13mm socket
- 10mm socket
- 10mm wrench
- 3/4" wrench
- flat blade screw driver
- 4mm allen.

**PARTS LIST:**

Description	Qty.	Part #	Description	Qty.	Part #	Description	Qty.	Part #
A hose clamp #52	2	08610	H hose clamp #60 stainless	1	08628	O bracket; 63-1015, "I", fin, tb/pc	1	070712
B hose; 3-1/4" id x 2" l	1	08690	I bolt; m6 x 1.00 x 16mm, ss	2	07730	P nut; 6mm nylock, hexhead, ss	2	07512
C intake tube (jt)	1	087288A	J washer, m6 split lock zinc	2	1-3025	Q bracket; I, 63-1569, stl, tb/pc	1	064323
D vent; 1/4 npt to quick	1	082628	K washer; 1/4" id x 5/8" od - sae	6	08275	R adapter; universal, 6" filter 3.5"	1	21512-1
E hose; 5/8" id x 9-3/4" l	1	084047	L edge trim (44")	1	102486	S hose clamp # 104	1	08697
F hose clamp #56	1	08620	M heat shield	1	073175	T air filter	1	RF-1048
G hose; hump 3.25/3.50 x 3.00"	1	5-576	N bolt; 6mm-1.00 x 16mm, ss	2	07812			

**NOTE: FAILURE TO FOLLOW INSTALLATION INSTRUCTIONS AND NOT USING THE PROVIDED HARDWARE MAY DAMAGE THE INTAKE TUBE, THROTTLE BODY AND ENGINE.**

**TO START:**

1. Turn off the ignition and disconnect the negative battery cable.  
**NOTE: Disconnecting the negative battery cable erases pre-programmed electronic memories. Write down all memory settings before disconnecting the negative battery cable. Some radios will require an anti-theft code to be entered after the battery is reconnected. The anti-theft code is typically supplied with your owner's manual. In the event your vehicles anti-theft code cannot be recovered, contact an authorized dealership to obtain your vehicles anti-theft code.**



2. Lift off the decorative engine cover.

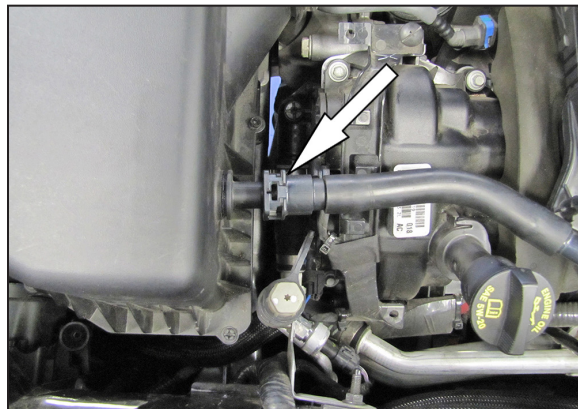

3. Disconnect the crank case vent hose from the air filter housing.

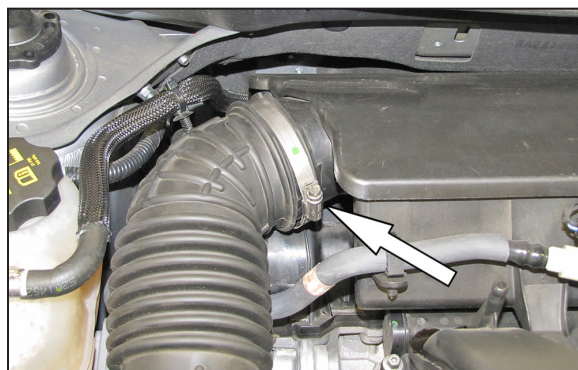

4. Loosen the hose clamp that secures the intake tube to the intake plenum.



5. Lift up the air filter housing to dislodge it from the mounting grommets and then remove the complete air filter housing assembly from the vehicle.  
**NOTE: K&N Engineering, Inc., recommends that customers do not discard factory air intake.**



6. Remove the two factory bolts shown.  
**NOTE: These bolts will be reused in a later step.**

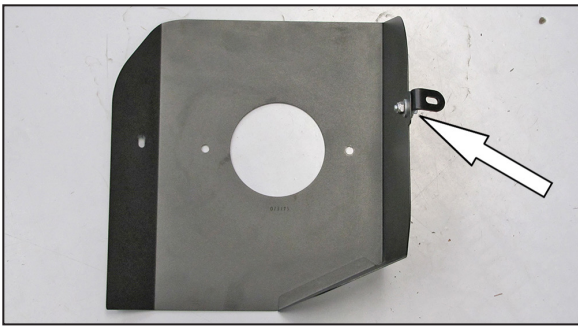

7. Install the heat shield mounting bracket (064323) onto the heat shield as shown using the provided hardware.

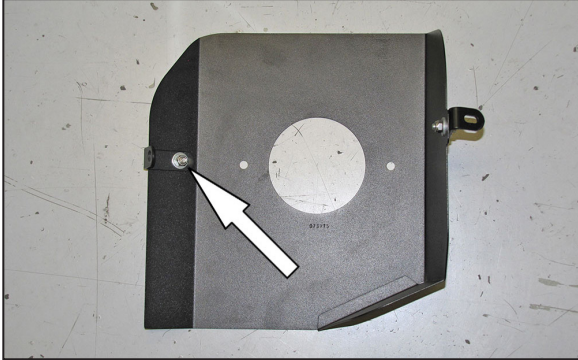

8. Install the heat shield mounting bracket (070712) onto the heat shield as shown using the provided hardware.

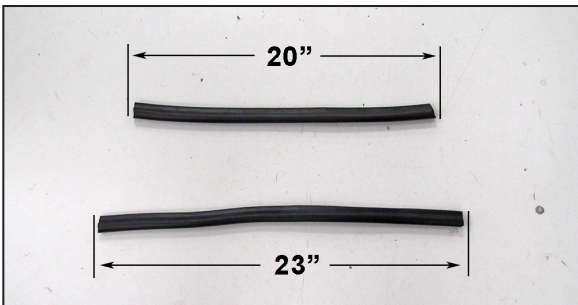

9. Cut the provided edge trim into two sections. One section will be 20" long, the other section will be 23" long.

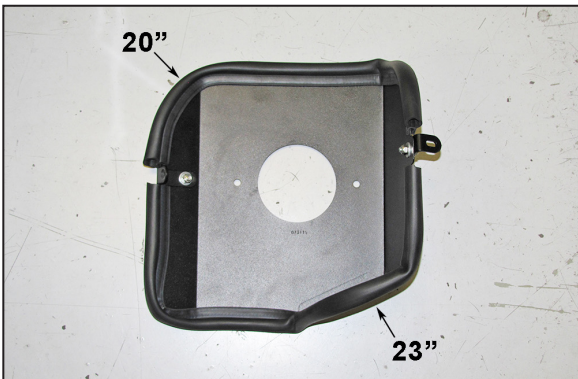

10. Install the provided edge trim onto the heat shield as shown.

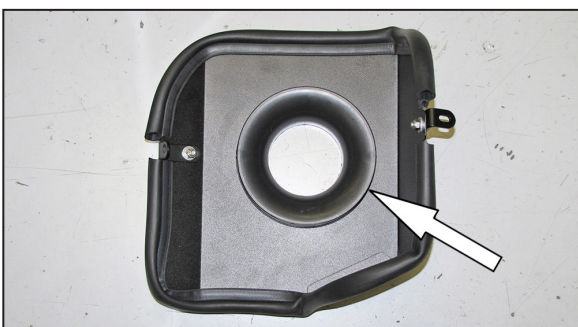

11. Install the filter adapter into the heat shield and secure with the provided hardware.



12. Install the K&N® air filter onto the filter adapter and secure with the provided hose clamp.  
**NOTE: Drycharger® air filter wrap; part # RF-1048DK is available to purchase separately. To learn more about Drycharger® filter wraps or look up color availability please visit <http://www.knfilters.com>®.**

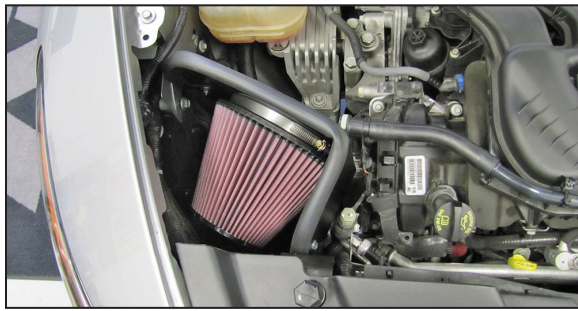

13. Install the heat shield assembly into the vehicle and secure with the hardware removed in step #6.  
**NOTE: Do not completely tighten at this time.**

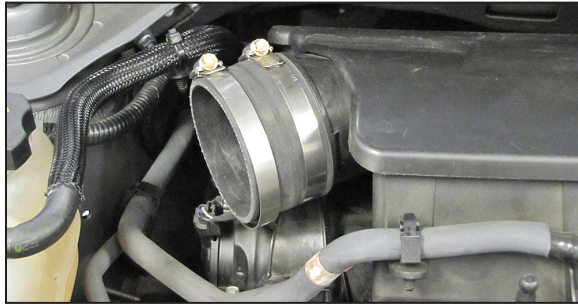

14. Install the provided coupler hose (08690) onto the intake plenum and secure with the provided hose clamp.



15. Install the provided quick disconnect fitting into the K&N® intake tube as shown.  
**NOTE: Plastic NPT fittings are easy to cross thread. Install the vent fitting "hand" tight, then turn it two complete turns with a wrench.**



16. Install the provided hump coupler (5-576) all the way onto the K&N® intake tube but do not secure at this time.



17. Install the K&N® intake tube into the coupler at the intake plenum and then slide the hump coupler onto the filter adapter. Adjust the intake tube for best fit and then secure with the provided hose clamps and heat shield mounting hardware.

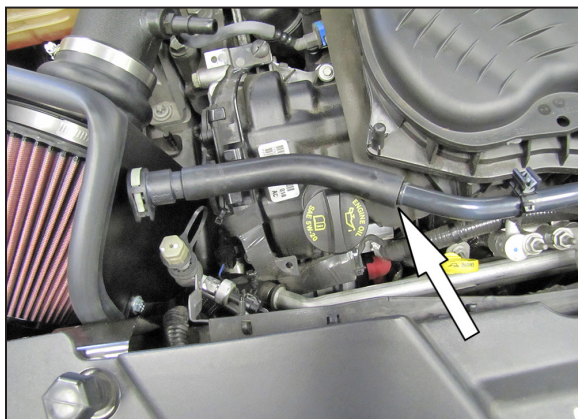

18. Remove the flexible crank case vent line from the hard line.



19. Remove the quick disconnect fitting from the factory flexible crank case vent line.

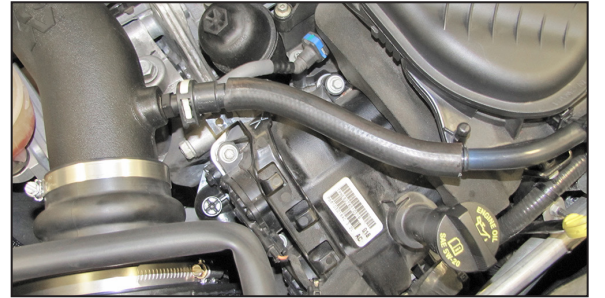

20. Install the factory quick disconnect fitting into the provided crank case vent hose and then install the assembly onto the factory hardline and connect the quick disconnect fitting to the fitting installed into the K&N® intake tube.



21. Reinstall the decorative engine cover.



22. Reconnect the vehicle's negative battery cable. Double check to make sure everything is tight and properly positioned before starting the vehicle.

23. It will be necessary for all K&N® high flow intake systems to be checked periodically for realignment, clearance and tightening of all connections. Failure to follow the above instructions or proper maintenance may void warranty.

#### ROAD TESTING:

1. Start the engine with the transmission in neutral or park, and the parking brake engaged. Listen for air leaks or odd noises. For air leaks secure hoses and connections. For odd noises, find cause and repair before proceeding. This kit will function identically to the factory system except for being louder and much more responsive.

2. Test drive the vehicle. Listen for odd noises or rattles and fix as necessary.

3. If road test is fine, you can now enjoy the added power and performance from your kit.

4. K&N Engineering, Inc., requires cleaning the intake system's air filter element every 100,000 miles. When used in dusty or off-road environments, our filters will require cleaning more often. We recommend that you visually inspect your filter once every 25,000 miles to determine if the screen is still visible. When the screen is no longer visible some place on the filter element, it is time to clean it. To clean and re-oil, purchase our filter Recharger® service kit, part number 99-5050 or 99-5000 and follow the easy instructions.

**NOT LEGAL FOR SALE OR USE ON ANY POLLUTION CONTROLLED MOTOR VEHICLE IN CALIFORNIA OR STATES ADOPTING CALIFORNIA EMISSION PROCEDURES.**

See [knfilters.com](http://knfilters.com) for CARB status on each part for a specific vehicle