



AIRCHARGER[®]

HIGH-FLOW INTAKE KITS

NOT LEGAL FOR SALE OR USE ON ANY POLLUTION CONTROLLED MOTOR VEHICLE IN CALIFORNIA OR STATES ADOPTING CALIFORNIA EMISSION PROCEDURES.
See knfilters.com for CARB status on each part for a specific vehicle

INSTALLATION INSTRUCTIONS

63-1114

DODGE / CHRYSLER

2011-15 Challenger

2011-15 Charger

2011-15 300C

V8-5.7L HEMI

TOOLS NEEDED:

- 4mm Allen
- 3/4" Drill Bit
- 10mm Socket
- 13mm Socket
- 10mm Wrench
- Drill
- Flat Blade Screwdriver
- Hack Saw
- Ratchet

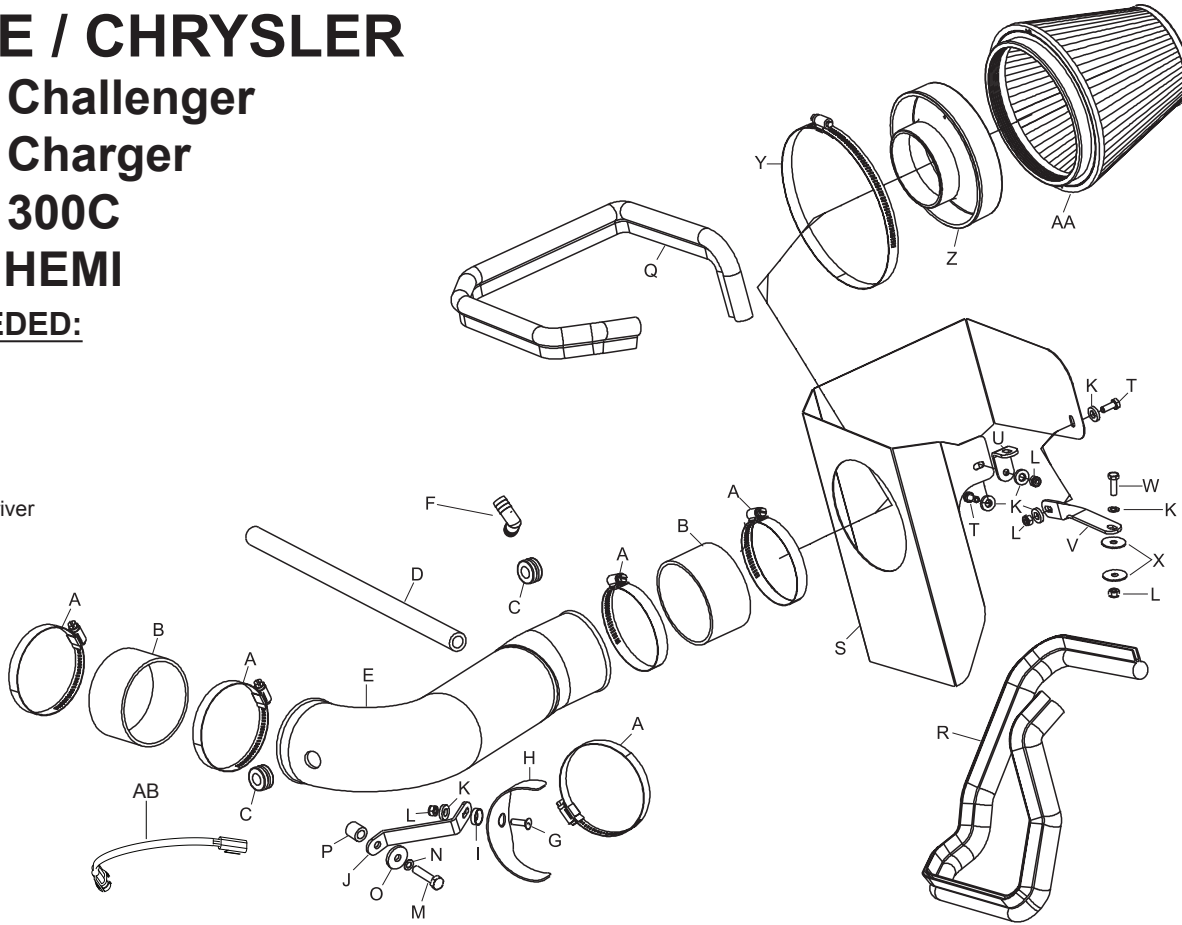

PARTS LIST:

Description	Qty.	Part #
A	5	08620
B	2	08630
C	2	08064
D	1	08177
E	1	087153
F	1	08065
G	1	08376
H	1	078855
I	1	08180
J	1	010088
K	6	08275
L	4	07553
M	1	07784
N	1	08239
O	1	08276
P	1	07849
Q	1	102489
R	1	102496
S	1	07498
T	2	07703
U	1	070066
V	1	070772
W	1	07865
X	2	08160
Y	1	08697
Z	1	21512-1
AA	1	RF-1042
AB	1	21680

NOTE: FAILURE TO FOLLOW INSTALLATION INSTRUCTIONS AND NOT USING THE PROVIDED HARDWARE MAY DAMAGE THE INTAKE TUBE, THROTTLE BODY AND ENGINE.

TO START:

1. Turn off the ignition and disconnect the negative battery cable.

NOTE: Disconnecting the negative battery cable erases pre-programmed electronic memories. Write down all memory settings before disconnecting the negative battery cable. Some radios will require an anti-theft code to be entered after the battery is reconnected. The anti-theft code is typically supplied with your owner's manual. In the event your vehicles' anti-theft code cannot be recovered, contact an authorized dealership to obtain your vehicles anti-theft code.

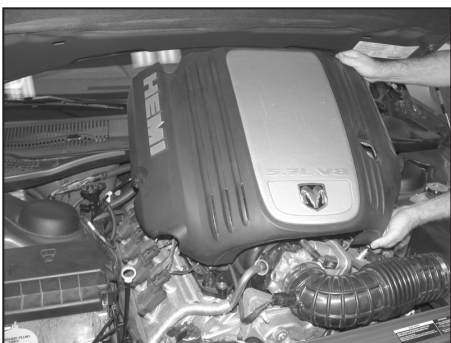

2. Lift up on the engine cover to loosen it from the mounts, and then remove the cover from the vehicle.



3. Unlock the red locking tab on the air temperature sensor electrical connection, then depress the locking lever and pull apart the temperature sensor electrical connection.

NOTE: Some vehicles may be equipped with an intake resonator near the inlet air temperature sensor.

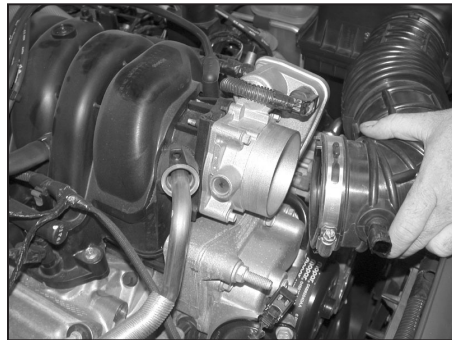

4. Loosen the hose clamp that secures the intake tube to the throttle body and pull the intake tube off of the throttle body.



5. Disconnect the crank case vent hose from the valve cover port as shown.

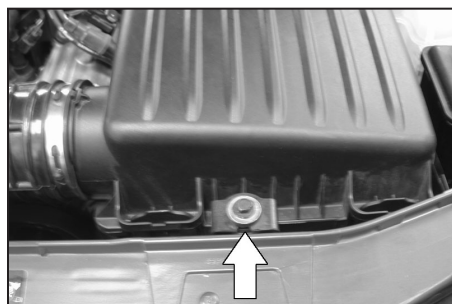

6. Loosen and remove the airbox mounting bolt as shown.



7. Lift the complete intake and air filter assembly to remove it from the vehicle.

NOTE: K&N Engineering, Inc., recommends that customers do not discard factory air intake.

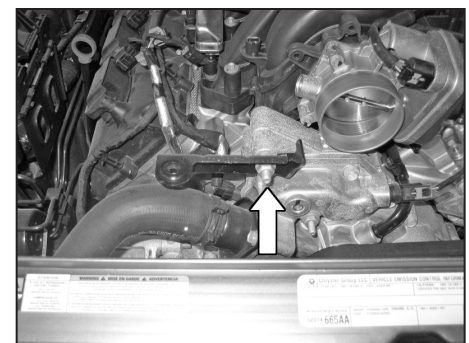

7a. On vehicles equipped with an intake resonator, remove the nut shown that secures the resonator bracket; remove the resonator bracket from the engine.



8. Install the twist bracket (070772) onto the core support using the hardware provided through the existing hole as shown.

NOTE: Use the two fender washers provided to sandwich the core support. Do not completely tighten at this time. On vehicles equipped with HID head lights, it will be necessary to install the mounting bolt from the bottom, this may be difficult but it will fit.

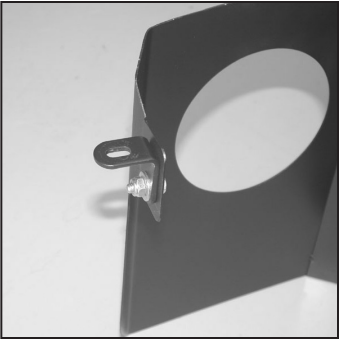

9. Install the "L" bracket (070066) onto the heat shield with the provided hardware through the non-slotted hole in the bracket.



10. Install the two pieces of edge trim onto the heat shield as shown, be sure to leave a gap at the bracket mounting locations.

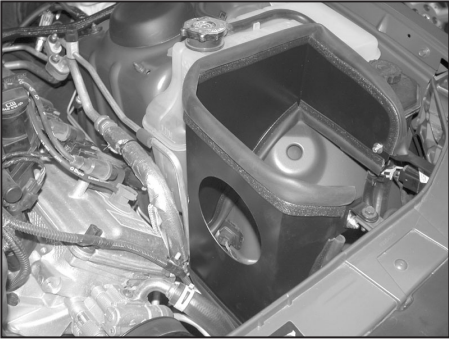

11. Install the heat shield assembly into the vehicle and secure to the bracket installed in step #8. Then secure the "L" bracket with the factory bolt removed in step #6 to the airbox mounting location.

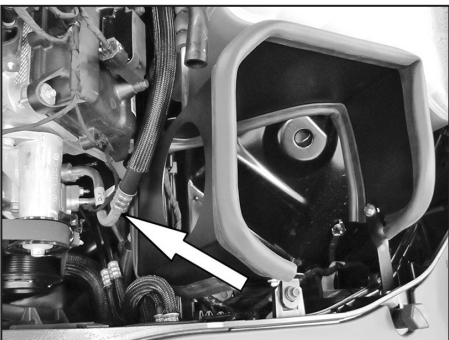
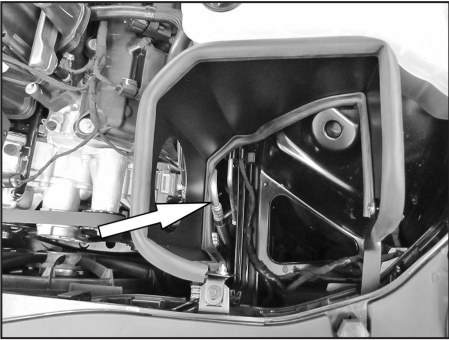

11a. Due to vehicle manufacturing tolerances, the A/C lines on some vehicles may need to be repositioned slightly so that they do not contact the heat shield. To adjust, grab the A/C line on the aluminum section and carefully apply pressure in the desired direction until clearance is obtained.



12. Assemble the tube mounting bracket and saddle clamp as shown with the provided hardware.

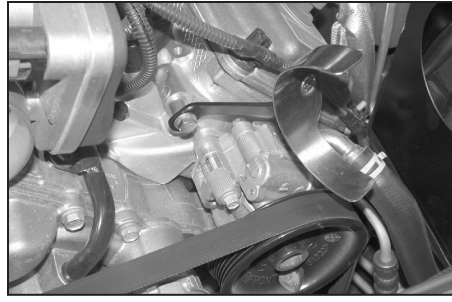

13. Using the provided spacer, install the tube mounting bracket assembly onto the engine as shown.

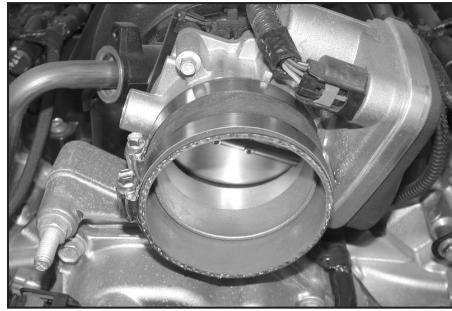

14. Install the silicone hose (08630) onto the throttle body and secure with the provided hose clamp as shown.

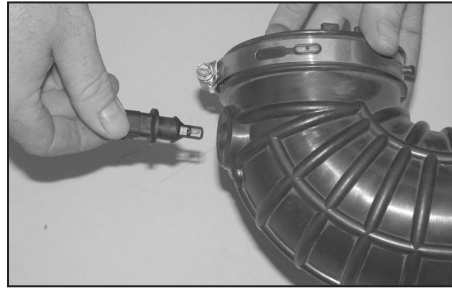

15. Remove the air temperature sensor from the factory intake tube.
NOTE: The inlet air temperature sensor may be a different style than the one shown.



16. Install the provided grommet into the K&N® intake tube as shown.



17. Install the factory air temperature sensor into the grommet installed in step #16.



18. Install the K&N® intake tube into the throttle body and onto the saddle clamp as shown, then secure with the hose clamps provided.



19. Install the provided crank case vent hose onto the vent port on the valve cover then install the vent hose onto the K&N® intake tube.

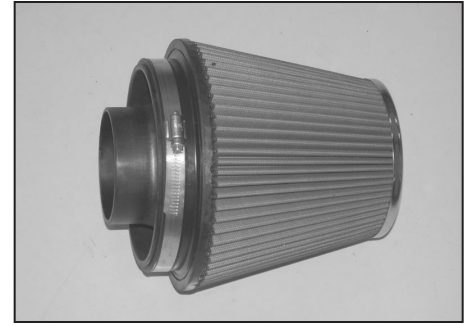

20. Install the filter adapter into the air filter and secure with the provided hose clamp.
NOTE: Drycharger® air filter wrap; part # RF-1042DK is available to purchase separately. To learn more about Drycharger® filter wraps or look up color availability please visit <http://www.knfilters.com>.



21. Install silicone hose (08630) onto the air filter assembly and secure with the provided hose clamp.

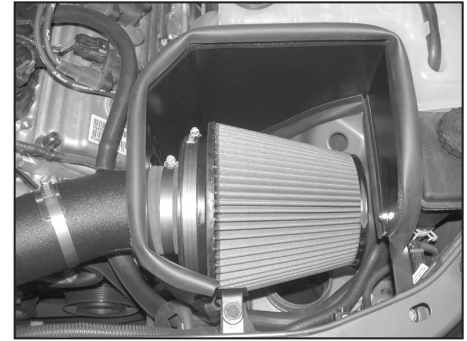

22. Install the air filter assembly onto the K&N® intake tube and secure with the provided hose clamp as shown.

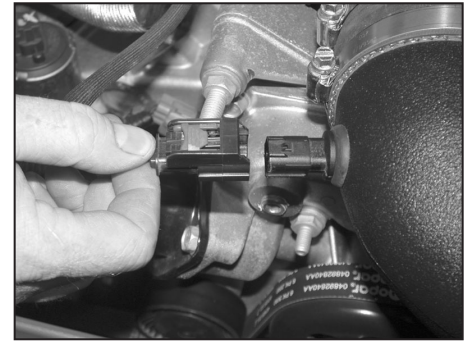

23. Reconnect the air temperature sensor electrical connection as shown.
NOTE: On 2012 and later model vehicles, it will be necessary to attach the provided extension harness to the factory wiring harness and connect it to the inlet air temperature sensor.

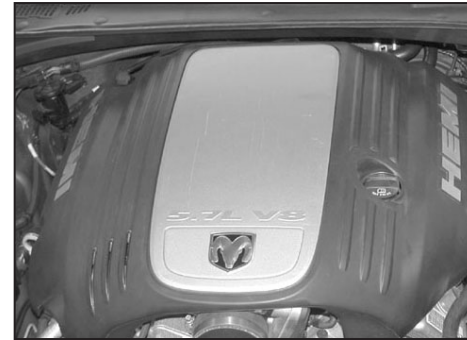

24. Reinstall the engine cover removed in step #2.



25. Reconnect the vehicle's negative battery cable. Double check to make sure everything is tight and properly positioned before starting the vehicle.

26. It will be necessary for all K&N® high flow intake systems to be checked periodically for realignment, clearance and tightening of all connections. Failure to follow the above instructions or proper maintenance may void warranty.

ROAD TESTING:

1. Start the engine with the transmission in neutral or park, and the parking brake engaged. Listen for air leaks or odd noises. For air leaks secure hoses and connections. For odd noises, find cause and repair before proceeding. This kit will function identically to the factory system except for being louder and much more responsive.

2. Test drive the vehicle. Listen for odd noises or rattles and fix as necessary.

3. If road test is fine, you can now enjoy the added power and performance from your kit.

4. K&N Engineering, Inc., requires cleaning the intake system's air filter element every 100,000 miles. When used in dusty or off-road environments, our filters will require cleaning more often. We recommend that you visually inspect your filter once every 25,000 miles to determine if the screen is still visible. When the screen is no longer visible some place on the filter element, it is time to clean it. To clean and re-oil, purchase our filter Recharger® service kit, part number 99-5050 or 99-5000 and follow the easy instructions.

NOT LEGAL FOR SALE OR USE ON ANY POLLUTION CONTROLLED MOTOR VEHICLE IN CALIFORNIA OR STATES ADOPTING CALIFORNIA EMISSION PROCEDURES.

See knfilters.com for CARB status on each part for a specific vehicle