



INTAKE SYSTEMS FOR VEHICLES LISTED ARE 50 STATE LEGAL. SEE KNFILTERS.COM FOR CARB STATUS ON EACH PART FOR A SPECIFIC VEHICLE.

INSTALLATION INSTRUCTIONS

- 57-3070**
CADILLAC / CHEVROLET / GMC
2009-14 Escalade ESV / EXT
V8-6.2L
2009-13 Avalanche
V8-5.3L / 6.0L
2009-13 Silverado 1500
V8-4.8L / 5.3L / 6.2L
2009-14 Suburban
V8-5.3L / 6.0L
2009-14 Tahoe
V8-4.8L / 5.3L / 6.2L
2009-14 Yukon, Denali / Denali XL / XL 1500
V8-4.8L / 5.3L / 6.2L
2009-13 Sierra, Denali 1500
V8-4.8L / 5.3L / 6.2L

NOTE: EXCLUDES HYBRID MODELS

NOTE: This kit was not designed to fit vehicles with a body lift.

TOOLS NEEDED:

- 1/2" Socket
- 5/8" Drill Bit
- 5/8" Wrench
- 10mm Socket
- Drill
- Extension
- Flat Blade Screwdriver
- Ratchet
- T15 Torx

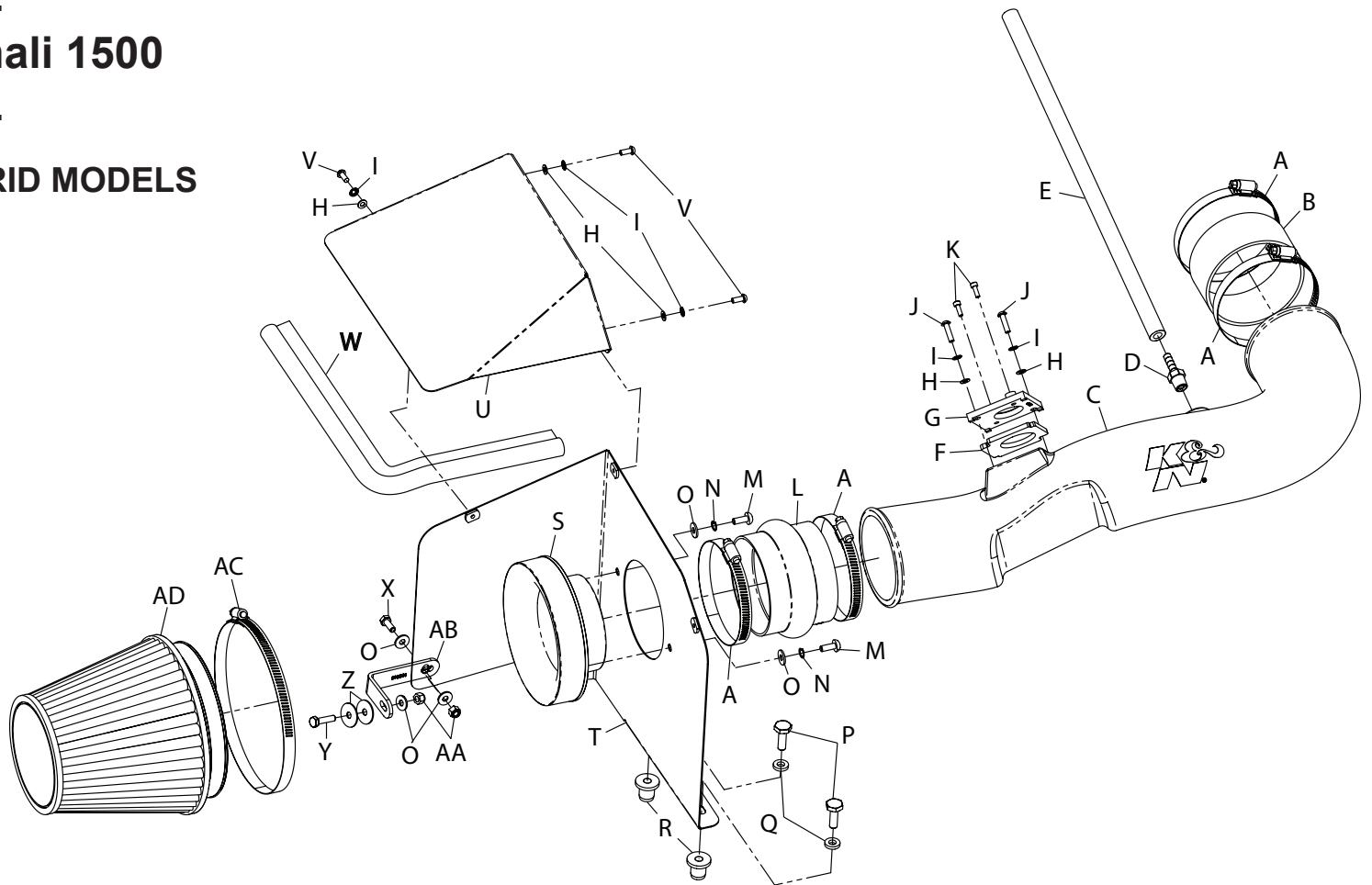

PARTS LIST:

Description	Qty.	Part #	Description	Qty.	Part #	Description	Qty.	Part #
A Hose Clamp #64 Stainless	4	08645	K Bolt; M4 - 0.07 8mm, A/H Cap, SS	2	07733	U Heat Shield;Top, Mild STL.	1	07326
B Hose; 4" ID X 2" L	1	08761	L Hose; 4" ID X 3" L Hump	1	08418	V Bolt; M5 - 0.8 X 12mm B/H,	3	07734
C Intake Tube	1	087265	M Bolt; M6 X 1.00 X 16mm, BttnHd.	2	07730	W Edge Trim (20")	1	102494
D Vent; Strt, 3/8" Hose, 1/4"NPT	1	08047	N Washer; 1/4" Lock, ZN	2	08198	X Bolt; M6-1.00 X 25mm, SS	1	07858
E Hose; 3/8" ID X 17" L	1	08404	O Washer; 6mm Flat, SS	5	08269	Y Bolt; 6mm-1.00 X 16mm, SS	1	07812
F Gasket; 3/16" Thk, Poron	1	09077	P Bolt; 5/16"-18 X 1"L, SS	2	07777	Z Washer; 1"D X 1/4 Hole	2	08160
G Adapter; Grivory	1	09403	Q Washer; 5/16"ID X 5/8"OD, Flat	2	08276	AA Nut; 6mm Nylcok, Hexhead	2	07512
H Washer; 5mm Flat, SS	5	08212	R Insert; 5/16-18 X .600 OD X .730L	2	088002	AB Bracket; "L" Small, STL,	1	010031
I Washer; 5mm Internal Star Cut	5	07724	S Adaptor; #454	1	27300	AC Hose Clamp #104	1	08697
J Bolt; M5-0.8 X 20mm, Bttnhd, SS	2	22208	T Heat Shield	1	07325	AD Air Filter	1	RF-1042XD

NOTE: FAILURE TO FOLLOW INSTALLATION INSTRUCTIONS AND NOT USING THE PROVIDED HARDWARE MAY DAMAGE THE INTAKE TUBE, THROTTLE BODY AND ENGINE.

TO START:

1. Turn off the ignition and disconnect the negative battery cable.
NOTE: Disconnecting the negative battery cable erases pre-programmed electronic memories. Write down all memory settings before disconnecting the negative battery cable. Some radios will require an anti-theft code to be entered after the battery is reconnected. The anti-theft code is typically supplied with your owner's manual. In the event your vehicles' anti-theft code cannot be recovered, contact an authorized dealership to obtain your vehicles anti-theft code.



2. Disconnect the mass air sensor electrical connection.



3. Lift up and remove the engine cover from the engine as shown.



4. Unhook the radiator hose mount from the intake tube.



5. Disconnect the crank case vent line from the intake tube plenum as shown.



6. Loosen the two hose clamps which secure the intake tube to the throttle body and air box, then remove the intake tube from the vehicle.



7. Pull up and remove the air box assembly from the vehicle as shown.
NOTE: K&N Engineering, Inc., recommends that customers do not discard factory air intake.

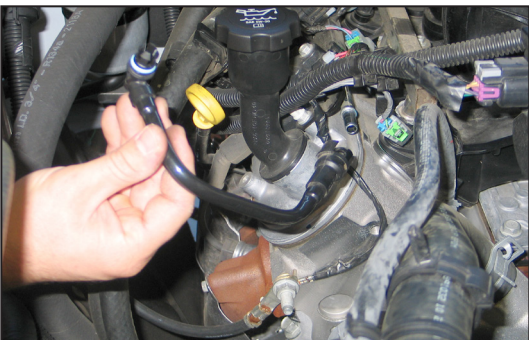

8. Rotate the crank case vent line on the valve cover, and then release the locking tab and remove the crank case vent line from valve cover port.

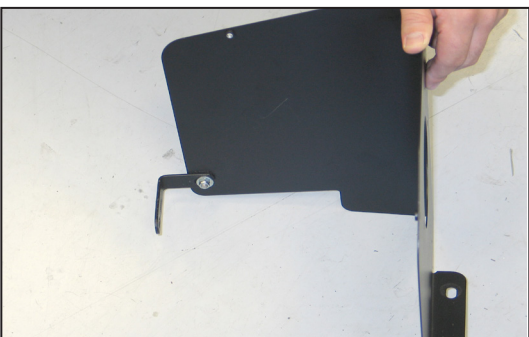

9. Install the heat shield mounting bracket (#010031) onto the heat shield as shown using the provided hardware.

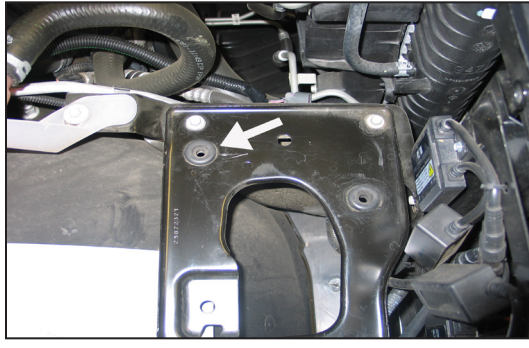

10. Remove the air box mounting grommet show.

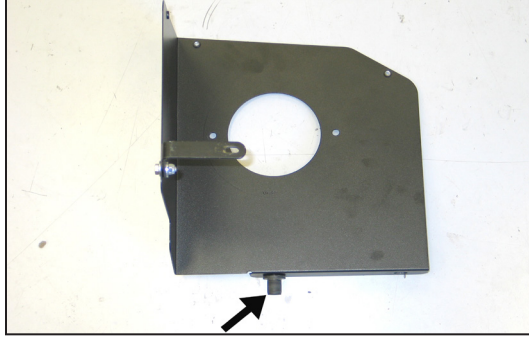

11. Secure one of the supplied 5/16" inserted nuts to the heat shield as shown using the provided hardware.

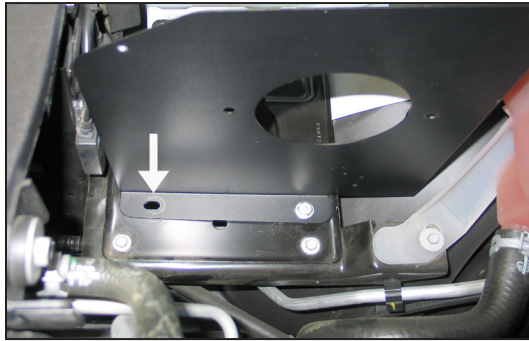

12. Set the heat shield assembly into position on the air box mounting tray so that the inserted nut sets into the air box mounting grommet hole. Mark the forward mounting location for drilling.

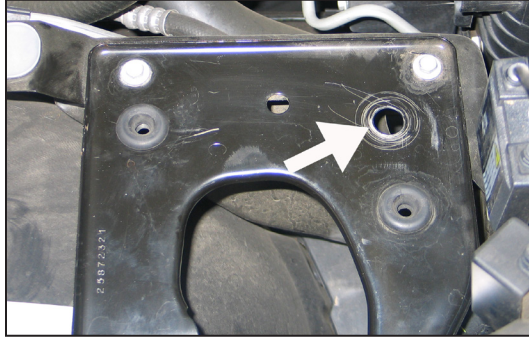

13. Remove the heat shield assembly and drill a 5/8" hole at the marked location.

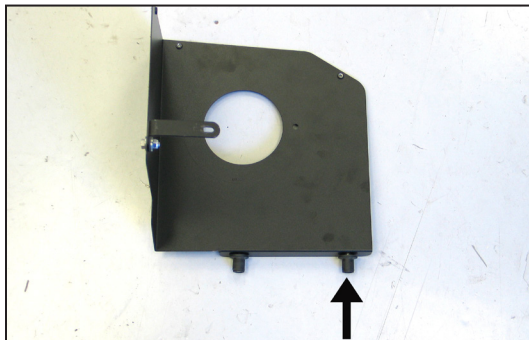

14. Install the remaining 5/16" inserted nut into the heat shield and secure with the provided hardware.

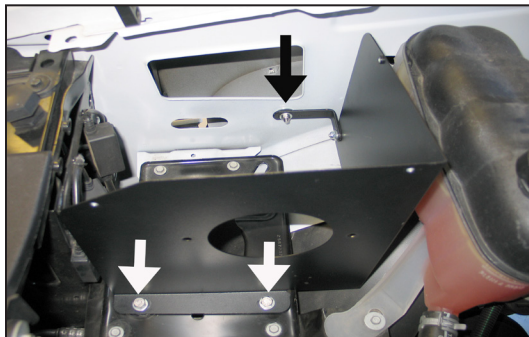

15. Reinstall the heat shield assembly, secure the mounting bracket to the inner fender with the provided hardware and then secure the two inserted nuts to the air box mounting tray.

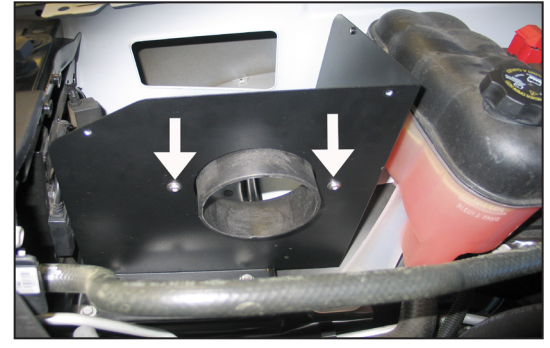

16. Install the filter adapter into the heat shield and secure with the provided hardware.

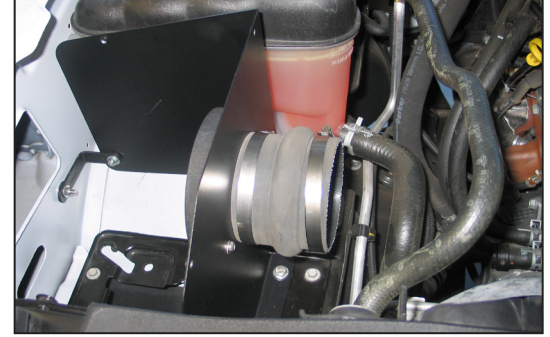

17. Install the silicone hose (#08418) onto the filter adapter and secure with the provided hose clamp.

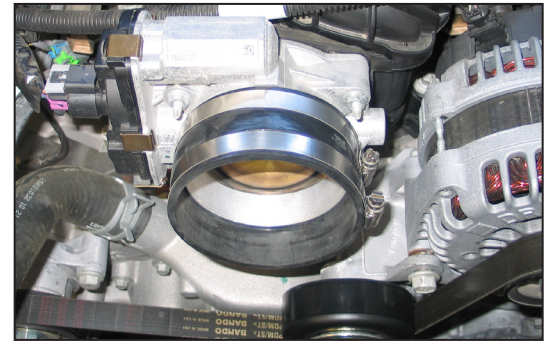

18. Install the provided silicone hose (#08761) onto the throttle body and secure with the provided hose clamp.

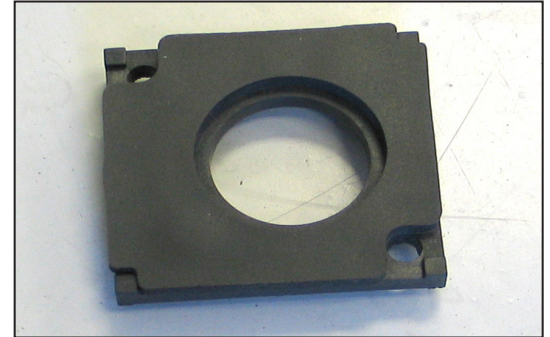

19. Peel the backing paper from the provided mass air sensor adapter gasket and then place the gasket onto the K&N® mass air sensor adapter as shown.



20. Remove the two screws which secure the mass air sensor to the factory air box and then remove the sensor from the air box.

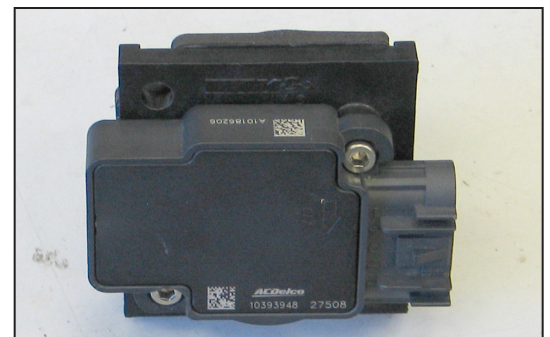

21. Install the mass air sensor into the K&N® mass air sensor adapter and secure with the provided hardware.

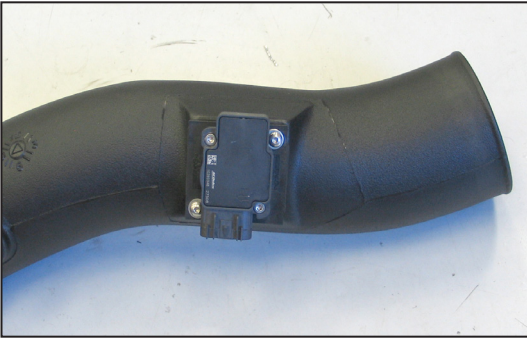

22. Install the mass air sensor assembly into the K&N® intake tube and secure with the provided hardware.

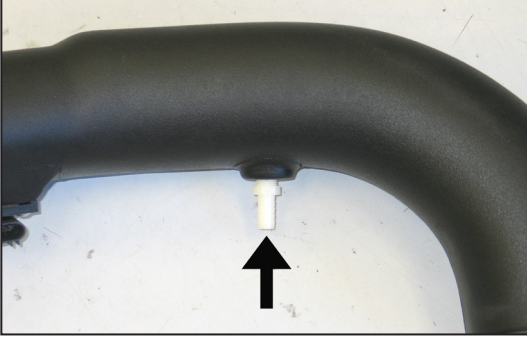

23. Install the provided 1/4" NPT fitting into the K&N® intake tube as shown.

NOTE: Plastic NPT fittings are easy to cross thread. Install the vent fitting "hand" tight, then turn it two complete turns with a wrench.



24. Install the K&N® intake tube into the silicone hose at the filter adapter and then into the silicone hose at the throttle body and secure with the provided hose clamps.

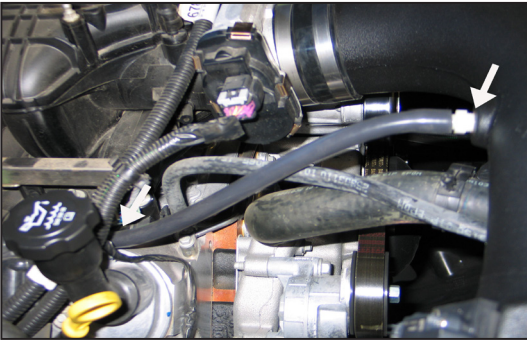

25. Install the provided silicone crank case vent hose onto the valve cover vent port and then to the 1/4" npt fitting in the K&N® intake tube as shown.

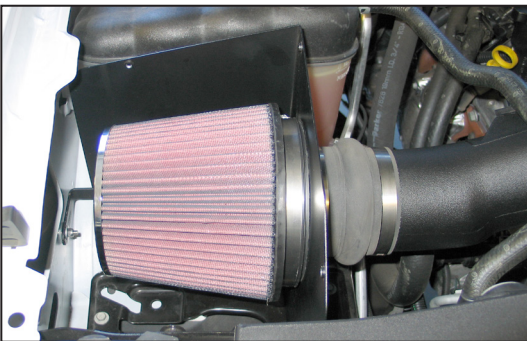

26. Install the K&N® air filter onto the filter adapter and secure with the provided hose clamp.

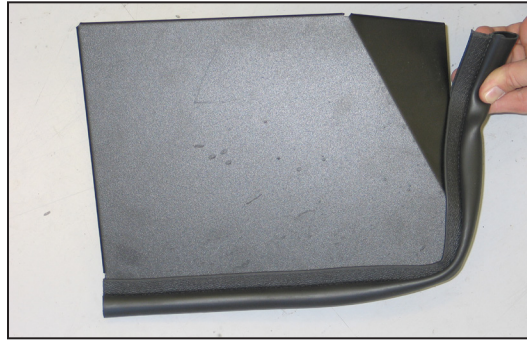

27. Install the provided edge trim onto the air filter cover as shown.

NOTE: Some trimming of the edge trim will be necessary.

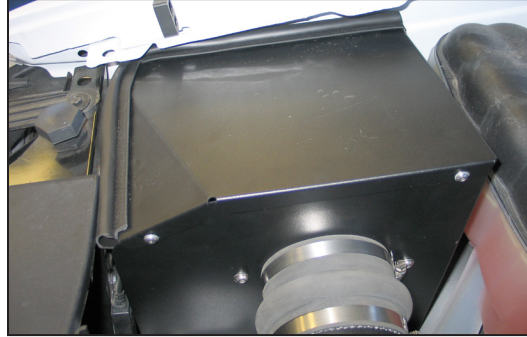

28. Install the air filter lid onto the heat shield and secure with the provided hardware.

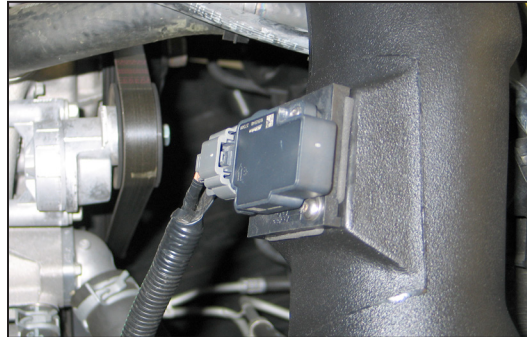

29. Reconnect the mass air sensor electrical connection.



30. Reinstall the factory engine cover.

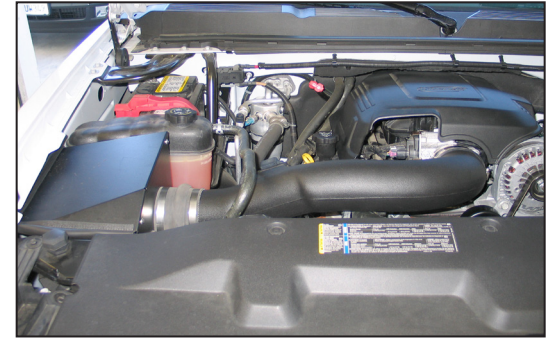

31. Reconnect the vehicle's negative battery cable. Double check to make sure everything is tight and properly positioned before starting the vehicle.

32. The C.A.R.B. exemption sticker, (attached), must be visible under the hood so that an emissions inspector can see it when the vehicle is required to be tested for emissions. California requires testing every two years, other states may vary.

33. **NOTE:** Most General Motors vehicles have the Vehicle Emissions Certification Information (VECI) label affixed to the air filter box. In order to be compliant with California emissions laws, the label **MUST** remain in the engine compartment. If the Vehicle Emission Control Information label is removed during modification, a new replacement label must be obtained and installed in a readily visible position in the engine compartment. The label shall not be affixed to any equipment which is easily detached from the vehicle. We recommend that the label is affixed to the underside of the hood adjacent to the hood latch. The label is Vehicle Identification Number dependent and can be ordered from the vehicle dealership. In order to receive the proper decal please bring your VIN with you. Failure to have the VECI under the hood may result in failure of a pre-registration smog test.

33. It will be necessary for all K&N® high flow intake systems to be checked periodically for realignment, clearance and tightening of all connections. Failure to follow the above instructions or proper maintenance may void warranty.

ROAD TESTING:

1. Start the engine with the transmission in neutral or park, and the parking brake engaged. Listen for air leaks or odd noises. For air leaks secure hoses and connections. For odd noises, find cause and repair before proceeding. This kit will function identically to the factory system except for being louder and much more responsive.

2. Test drive the vehicle. Listen for odd noises or rattles and fix as necessary.

3. If road test is fine, you can now enjoy the added power and performance from your kit.

4. K&N Engineering, Inc., requires cleaning the intake system's air filter element every 100,000 miles. When used in dusty or off-road environments, our filters will require cleaning more often. We recommend that you visually inspect your filter once every 25,000 miles to determine if the screen is still visible. When the screen is no longer visible some place on the filter element, it is time to clean it. To clean and re-oil, purchase our filter Recharger® service kit, part number 99-5050 or 99-5000 and follow the easy instructions.

INTAKE SYSTEMS FOR VEHICLES LISTED ARE 50 STATE LEGAL. SEE KNFILTERS.COM FOR CARB STATUS ON EACH PART FOR A SPECIFIC VEHICLE.