



INTAKE SYSTEMS FOR VEHICLES LISTED ARE 50 STATE LEGAL. SEE KNFILTERS.COM FOR CARB STATUS ON EACH PART FOR A SPECIFIC VEHICLE.

INSTALLATION INSTRUCTIONS

57-3048 CHEVROLET / GMC 2003-04 Trailblazer / Envoy V8-5.3L

NOTE: This kit was not designed to fit vehicles with a body lift.

TOOLS NEEDED:

- Ratchet
- Extension
- 13mm Socket
- 10mm Wrench
- 17mm Wrench
- Phillips Screwdriver
- Flat Blade Screwdriver
- 4mm Allen Wrench
- 5mm Allen Wrench
- Drill
- 5/8" Drill Bit

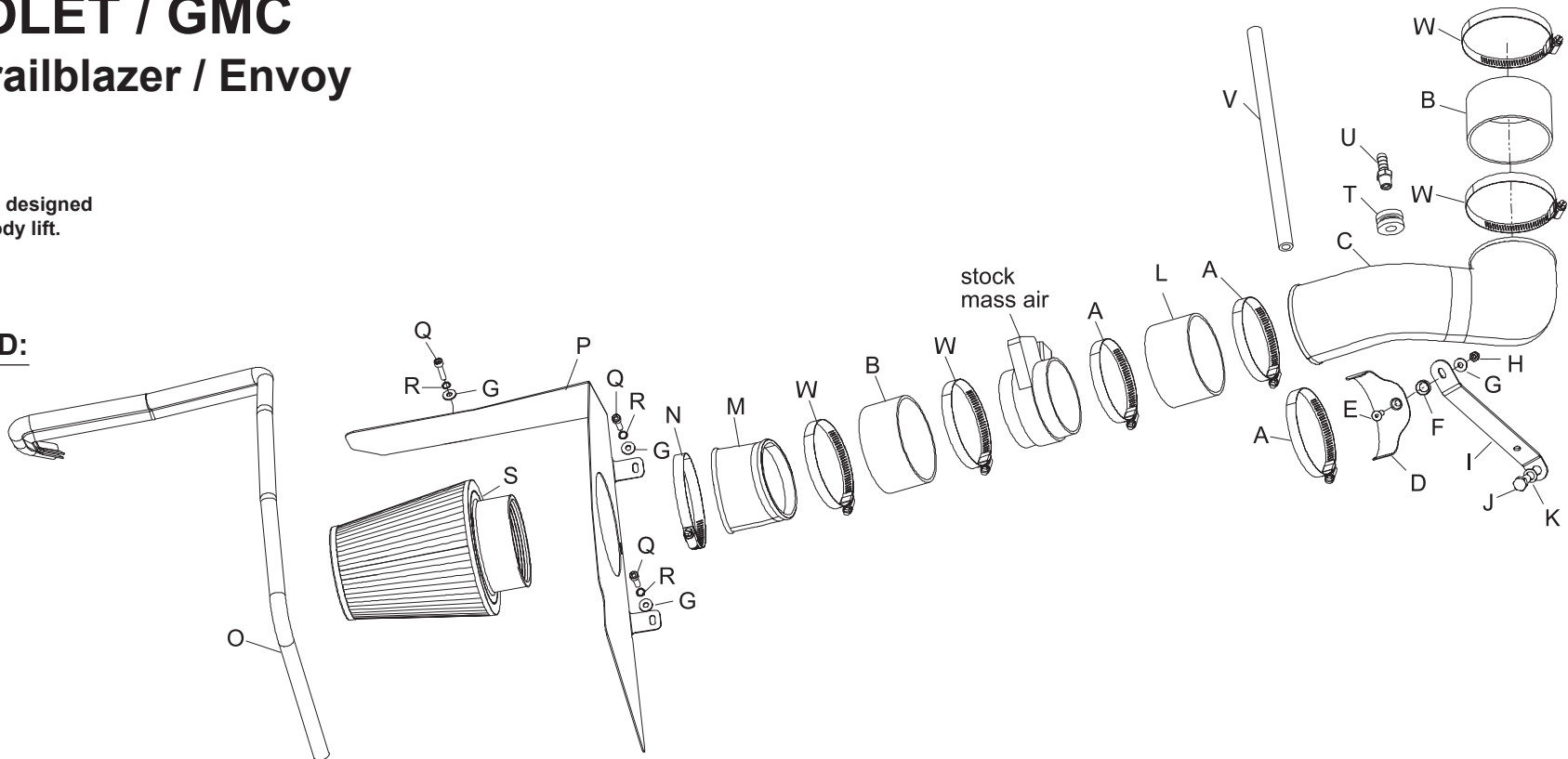

PARTS LIST:

Description	Qty.	Part #	Description	Qty.	Part #	Description	Qty.	Part #
A hose clamp #60	3	08624	I bracket	1	010085	Q bolt; 6mm-1.00 x 25mm allen	3	07859
B silicone hose 4" id x 2" l	2	08625	J bolt m10-1.5 x 25mm	1	07702	R washer; 1/4" split lock	3	08198
C intake tube "EI"	1	087136	K washer; 10mm wave	1	08175	S air filter	1	RF-1032
D saddle bracket	1	078855	L silicone hose 3.75" id x 2.25" l	1	08631	T grommet; 15/16" od, 3/8" id	1	08100
E bolt; 6mm-1.00x20mm f/h/a	1	08376	M intake tube EH"	1	087135	U vent; str 3/8" hose	1	08041
F washer; black nylon,	1	08180	N hose clamp #64	1	08648	V silicone hose 5/16" id x 21" l	1	08409
G washer; 1/4" flat	4	08275	O edge trim	1	102496	W hose clamp #64 stainless	4	08645
H nut; 6mm nylock	1	07553	P heat shield	1	07490			

NOTE: FAILURE TO FOLLOW INSTALLATION INSTRUCTIONS AND NOT USING THE PROVIDED HARDWARE MAY DAMAGE THE INTAKE TUBE, THROTTLE BODY AND ENGINE.

TO START:

1. Turn off the ignition and disconnect the negative battery cable.
NOTE: Disconnecting the negative battery cable erases pre-programmed electronic memories. Write down all memory settings before disconnecting the negative battery cable. Some radios will require an anti-theft code to be entered after the battery is reconnected. The anti-theft code is typically supplied with your owner's manual. In the event your vehicles anti-theft code cannot be recovered, contact an authorized dealership to obtain your vehicles anti-theft code.

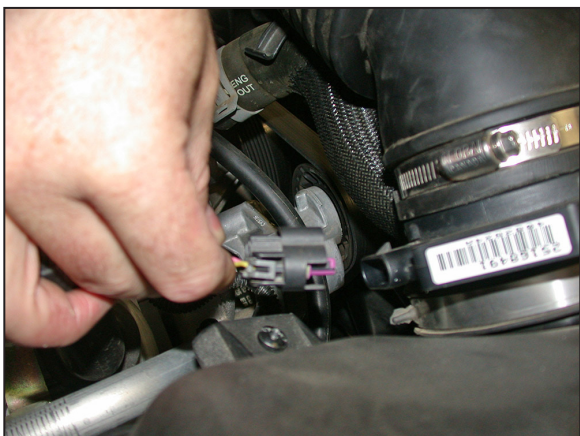

2. Depress the locking tab on the mass air sensor electrical connection and then separate the connector from the mass air sensor.

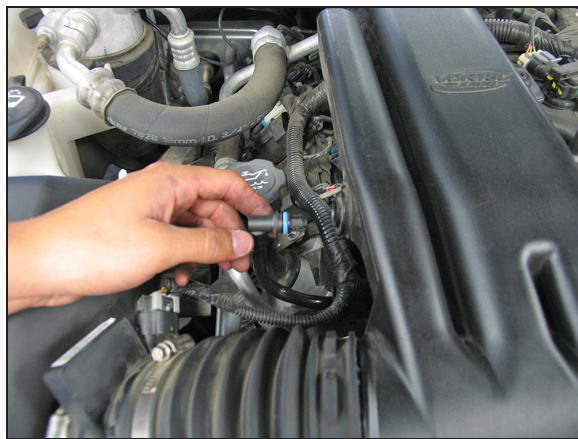

2a. On vehicles equipped with crank case vent hose, unhook the crank case vent from the intake tube as shown.



3. Loosen the two hose clamps which secure the stock intake tube, mass air sensor and throttle body, then lift the intake tube to release it from the rubber mount on the intake manifold and remove it from the vehicle.

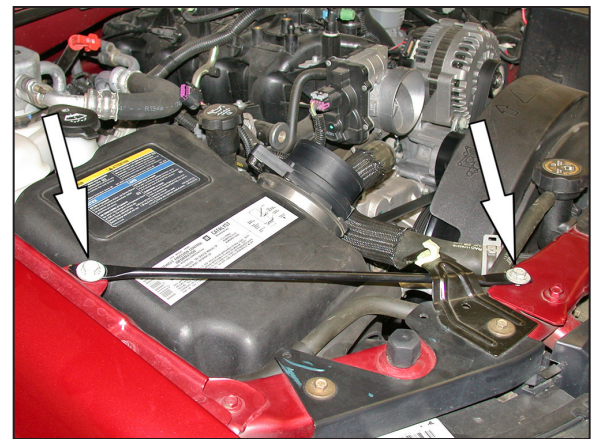

4. Remove the two bolts, which secure the core support brace to the core support and inner fender, and then remove the brace from the vehicle.

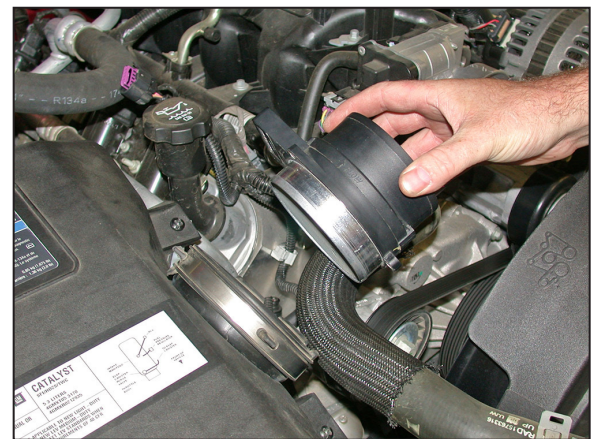

5. Loosen the hose clamp, which secures the mass air sensor to the air box, then remove the mass air sensor from the air box.

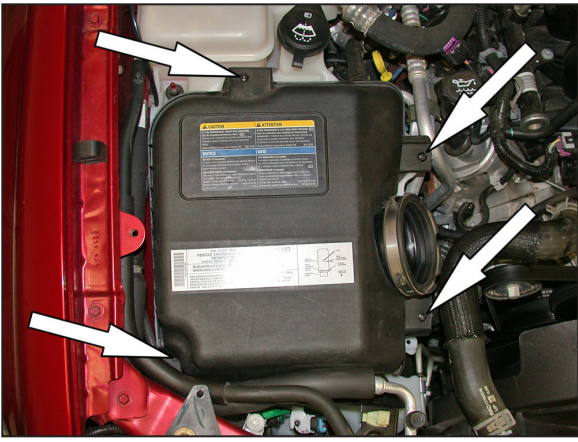

6. Loosen and remove the four screws that secure the upper air box lid.



7. Remove the upper air box lid from the vehicle as shown.



8. Remove the stock air filter assembly from the vehicle as shown.
NOTE: K&N Engineering, Inc., recommends that customers do not discard factory air intake.



9. Remove the fresh air supply tube from the lower air box / washer reservoir housing.

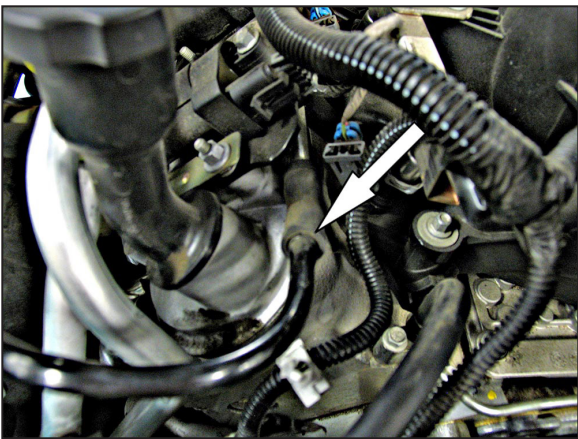

9a. On vehicles equipped with a crank case vent hose, remove the factory vent hose from the valve cover vent port shown.

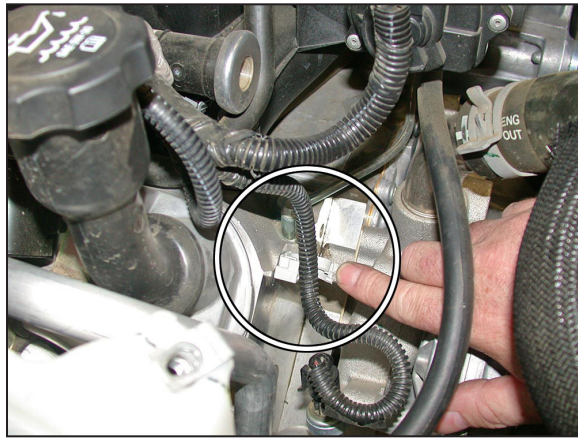

10. Using a screwdriver unlock the wiring harness from the retaining clip attached to the engine as shown.

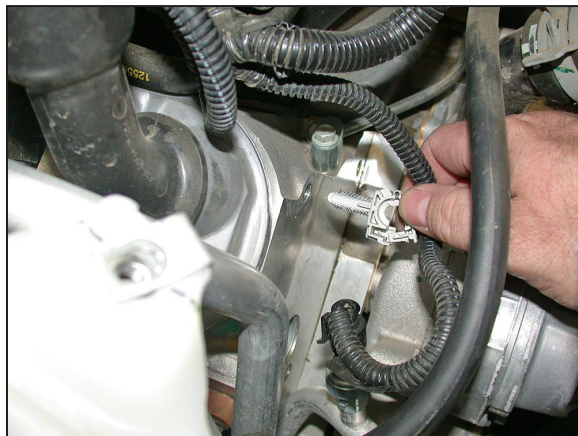

11. Unthread the retaining clip from the engine as shown.



12. Assemble the saddle clamp to the tube bracket as shown using the provided hardware.

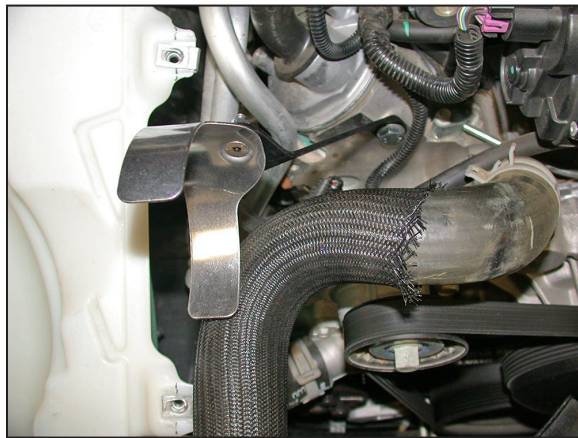

13. Install the tube bracket assembly onto the engine using the hardware provided.
NOTE: The supplied bolt threads into the threaded hole in the engine vacated by the wire harness clip in step #11.



14. Install the wiring harness retaining clip removed in step #11 into the new tube mounting bracket, and then resecure the wire harness to the clip as shown.

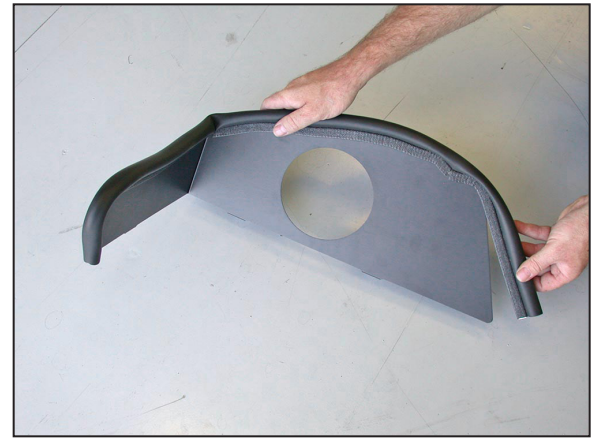

15. Install the provided edge trim onto the heat shield as shown.
NOTE: Some trimming may be necessary.



16. Install the heat shield assembly into the vehicle using the provided hardware.



17. Install the provided silicone hose (08625) onto the throttle body and secure with the provided hose clamp as shown.



18. Install the provided silicone hose (08631) onto the mass air sensor and secure with the provided hose clamp as shown.



18a. On vehicles equipped with a crank case vent, mark the tube 4" back from the end of the tube and 1/2" below the mold seam then drill a 5/8" id hole.



18b. Install the provided grommet into the hole drilled into the intake tube in step #18a.



19. Install the mass air sensor assembly onto the K&N intake tube (EI) as shown.

NOTE: Do not completely tighten at this time.

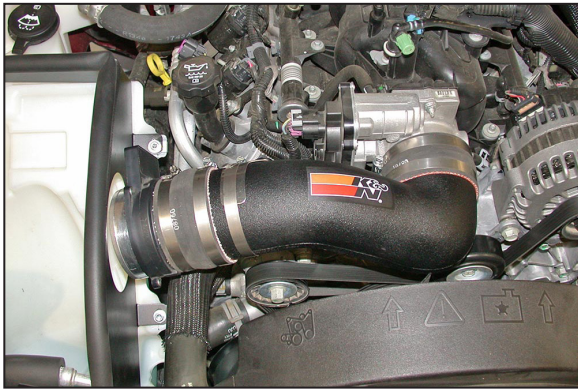

20. Install the K&N® intake tube assembly into the silicone hose at the throttle body and onto the saddle clamp as shown, then secure with the provided hose clamps.



20a. On vehicles equipped with a crank case vent hose, install the supplied hose mender into the supplied crank case vent hose fitting.

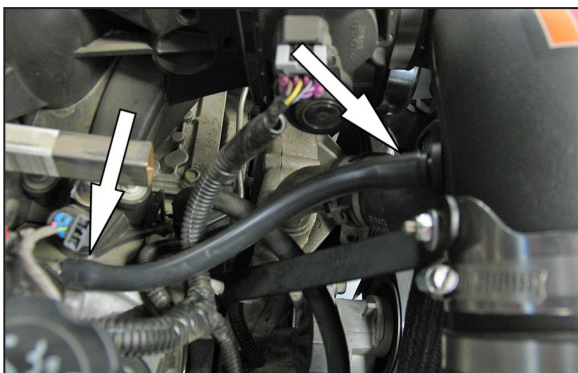

20b. Install the crank case vent assembly onto the valve cover fitting and then into the grommet installed into the K&N® intake tube as shown.

NOTE: Some trimming of the vent hose will be necessary.



21. Install the supplied silicone hose (08625) onto the small diameter end of the "EH" K&N® intake tube.



22. Install the "EH" tube assembly onto the mass air sensor and secure with the provided hose clamp.



23. Install the K&N® air filter onto K&N® intake tube and secure with the provided hose clamp.

NOTE: Drycharger® air filter wrap; part # RF-1032DK is available to purchase separately. To learn more about Drycharger® filter wraps or look up color availability please visit <http://www.knfilters.com>®.



24. Re-install the core support brace removed in step #4 with the stock hardware.

NOTE: Adjust the air filter and intake tube at this time for minimum of 1/2" clearance then tighten the hose clamps.

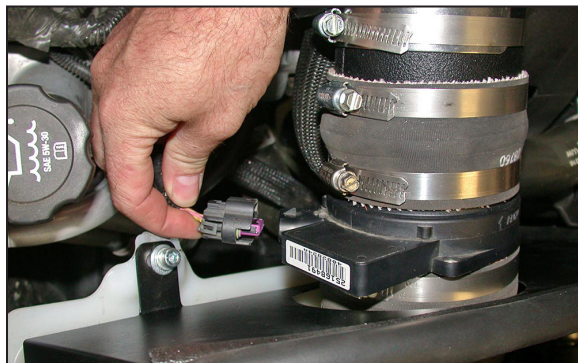

25. Reconnect the mass air sensor electrical connection as shown.



26. Reconnect the vehicle's negative battery cable. Double check to make sure everything is tight and properly positioned before starting the vehicle.

27. The C.A.R.B. exemption sticker, (attached), must be visible under the hood so that an emissions inspector can see it when the vehicle is required to be tested for emissions. California requires testing every two years, other states may vary.

28. **NOTE:** Most General Motors vehicles have the Vehicle Emissions Certification Information (VECI) label affixed to the air filter box. In order to be compliant with California emissions laws, the label **MUST** remain in the engine compartment. If the Vehicle Emission Control Information label is removed during modification, a new replacement label must be obtained and installed in a readily visible position in the engine compartment. The label shall not be affixed to any equipment which is easily detached from the vehicle. We recommend that the label is affixed to the underside of the hood adjacent to the hood latch. The label is Vehicle Identification Number dependent and can be ordered from the vehicle dealership. In order to receive the proper decal please bring your VIN with you. Failure to have the VECI under the hood may result in failure of a pre-registration smog test.

29. It will be necessary for all K&N® high flow intake systems to be checked periodically for realignment, clearance and tightening of all connections. Failure to follow the above instructions or proper maintenance may void warranty.

ROAD TESTING:

1. Start the engine with the transmission in neutral or park, and the parking brake engaged. Listen for air leaks or odd noises. For air leaks secure hoses and connections. For odd noises, find cause and repair before proceeding. This kit will function identically to the factory system except for being louder and much more responsive.

2. Test drive the vehicle. Listen for odd noises or rattles and fix as necessary.

3. If road test is fine, you can now enjoy the added power and performance from your kit.

4. K&N Engineering, Inc., requires cleaning the intake system's air filter element every 100,000 miles. When used in dusty or off-road environments, our filters will require cleaning more often. We recommend that you visually inspect your filter once every 25,000 miles to determine if the screen is still visible. When the screen is no longer visible some place on the filter element, it is time to clean it. To clean and re-oil, purchase our filter Recharger® service kit, part number 99-5050 or 99-5000 and follow the easy instructions.

INTAKE SYSTEMS FOR VEHICLES LISTED ARE 50 STATE LEGAL. SEE KNFILTERS.COM FOR CARB STATUS ON EACH PART FOR A SPECIFIC VEHICLE.