



INTAKE SYSTEMS FOR VEHICLES LISTED ARE 50 STATE LEGAL. SEE KNFILTERS.COM FOR CARB STATUS ON EACH PART FOR A SPECIFIC VEHICLE.

INSTALLATION INSTRUCTIONS

57-3026
CHEVROLET / GMC
1988-95 C/K Pickup / Sierra
1992-95 Blazer / Tahoe / Yukon
1992-95 Suburban
V8-5.0L / 5.7L

NOTE: This kit was not designed to fit vehicles with a body lift.

TOOLS NEEDED:

- 13mm Wrench
- 8mm Wrench
- T25 Torx Driver
- 3/8 Wrench
- 7/16 Wrench
- Flat Blade Screwdriver
- 10mm Allen Wrench
- 4mm Allen Wrench

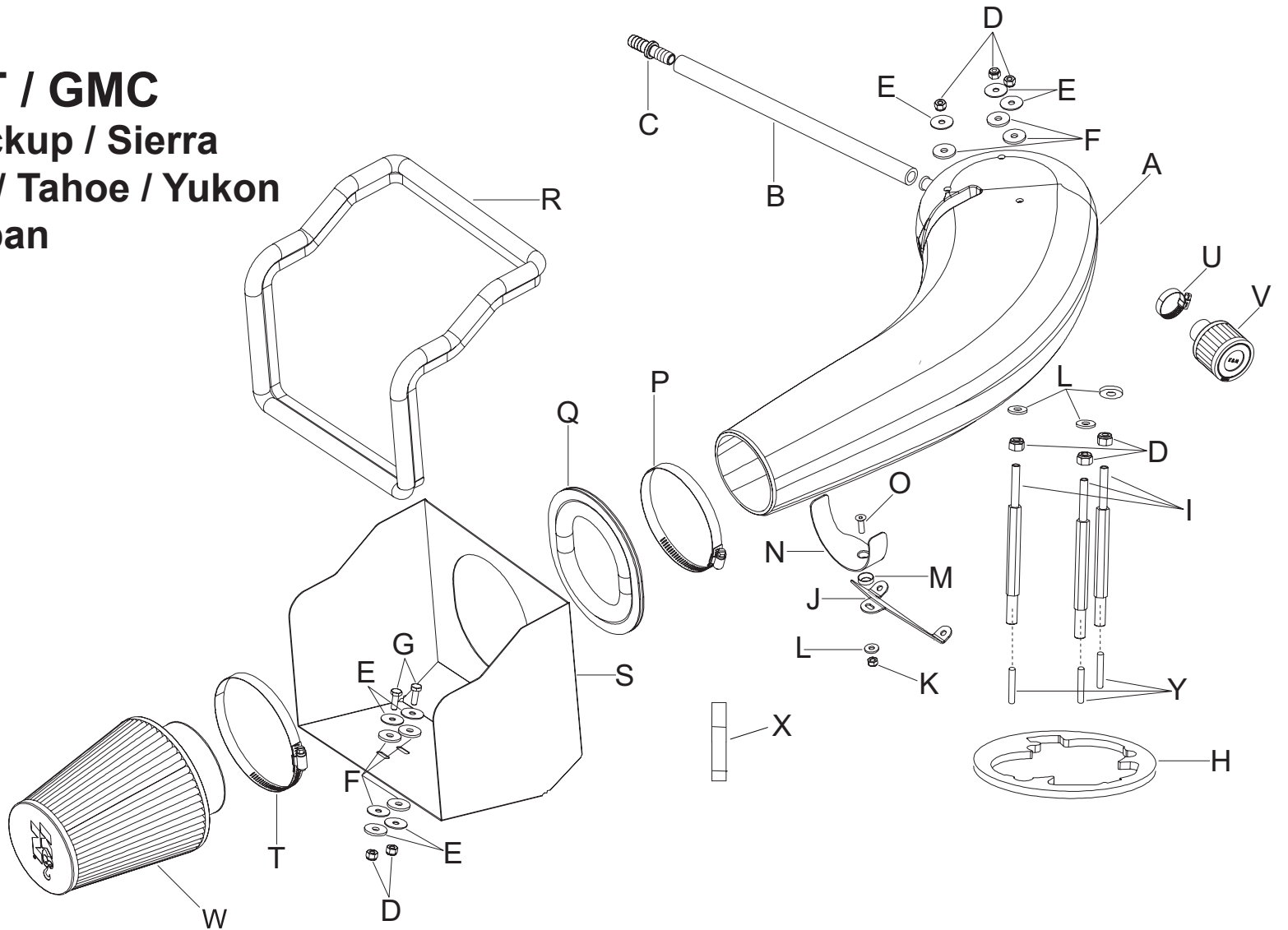

PARTS LIST:

Description	Qty.	Part #	Description	Qty.	Part #	Description	Qty.	Part #
A Intake Tube	1	08779	J Bracket	1	070862	S Heat Shield	1	07441
B Hose; 1/2"ID x 14"L Silicone	1	08402	K Nut; 6mm Nylock, Hexhead	1	07553	T Hose Clamp #64	1	08648
C Hose; Mender 1/2" Barbed	1	08686	L Washer; 1/4"ID x 5/8"OD - SAE	4	08275	U Hose Clamp #12 mini	1	08420
D Nut; 1/4-20, Nylock, Zinc	8	07517	M Washer; Conical, Nylon, Black	1	08180	V Vent Filter	1	RU-3630
E Washer; 1"D x 1/4 Hole Fender	7	08160	N Saddle Bracket	1	078855	W Air Filter	1	RF-1032
F Washer; 1" x .300 x .100 Rubber	7	21685	O Bolt; 6mm-1.00x20mm F/H/A	1	08376	X Thread Locker	1	482
G Bolt; 1/4-20 x 3/4 Hexhead	2	08386	P Hose Clamp #72	1	08671	Y Stud; 5mm-.8 x 30mm L	3	22211
H Gasket	1	09027	Q Edge Trim 20"	1	102476			
I Stud	3	09795-1	R Edge Trim 48"	1	102485			

NOTE: FAILURE TO FOLLOW INSTALLATION INSTRUCTIONS AND NOT USING THE PROVIDED HARDWARE MAY DAMAGE THE INTAKE TUBE, THROTTLE BODY AND ENGINE.

TO START:

1. Turn off the ignition and disconnect the negative battery cable.
NOTE: Disconnecting the negative battery cable erases pre-programmed electronic memories. Write down all memory settings before disconnecting the negative battery cable. Some radios will require an anti-theft code to be entered after the battery is reconnected. The anti-theft code is typically supplied with your owner's manual. In the event your vehicles' anti-theft code cannot be recovered, contact an authorized dealership to obtain your vehicles anti-theft code.



2. Loosen and remove the air cleaner wing nuts, then remove the air cleaner lid.



3. Disconnect the cold inlet tube and then remove the air cleaner base assembly as shown.
NOTE: Some vehicles are equipped with an air injection check valve which is vented to the air cleaner assembly. On these vehicles, remove the rubber hose and clamp the provided filter to the check valve.



4. Loosen and remove the two bolts that secure the air inlet/resonator, then remove the assembly as shown.

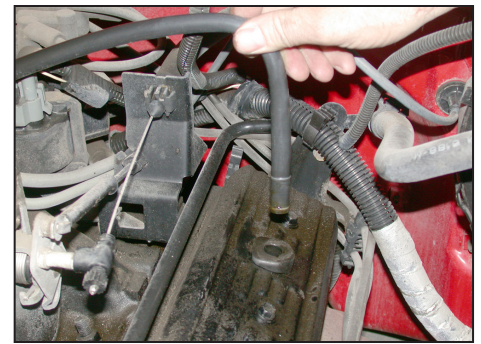

5. Remove the crank case vent line from the valve cover as shown.



6. Remove the throttle body spacer as shown.
NOTE: K&N Engineering, Inc., recommends that customers do not discard factory air intake.

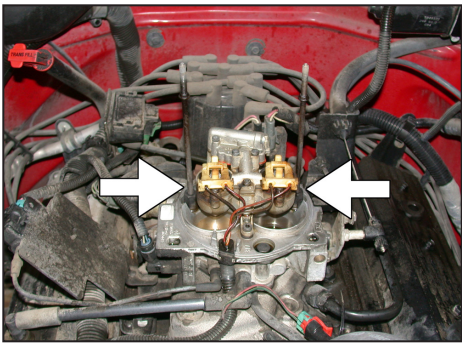

7a. On 92-95 vehicles, remove the two factory throttle body studs as shown.

7b. On 88-91 vehicles, remove the factory "Z" stud.

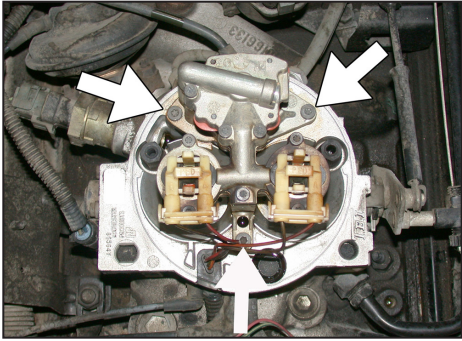

8. Remove the three factory torx screws as shown.

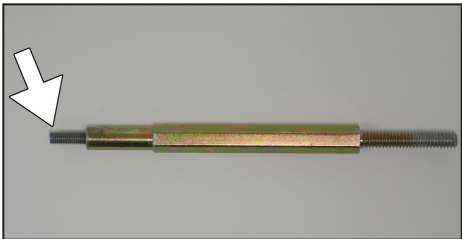

8a. Apply two drops of the provided thread locker onto the threads of the 5mm stud and then thread the stud into the tube mounting stud as shown.

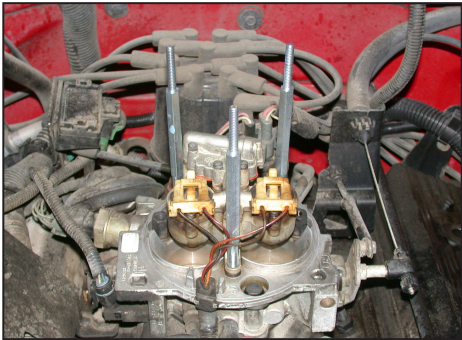

9. Install the three provided throttle body studs into the three holes from step 8.

NOTE: Apply two drops of thread locker to the throttle body studs and torque them to 30 inch-pounds. Failure to follow the above instructions may damage the throttle body.

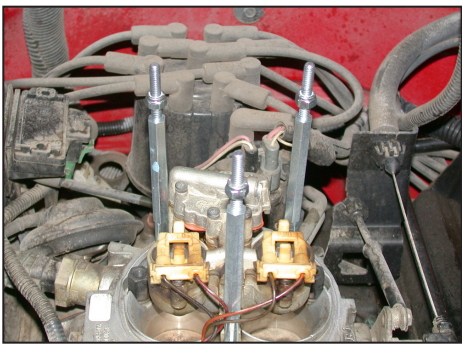

10. Install the three provided nylock nuts onto the throttle body studs approximately 3/4" down as shown.

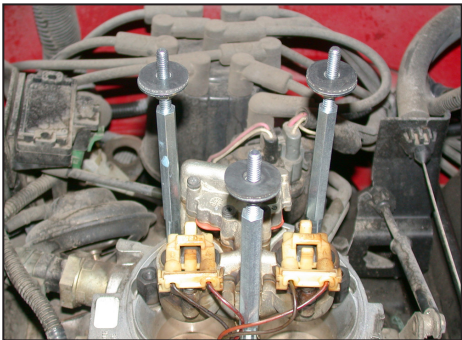

11. Install the three flat washers onto the throttle body studs as shown.



12. Install the long piece of trim seal onto the heat shield as shown.

NOTE: Some trimming of the edge trim will be necessary.



13. Install the short piece of trim seal to the heat shield as shown.

NOTE: Some trimming of the edge trim will be necessary.



14. Install the heat shield to the inner fender using the provided hardware as shown.

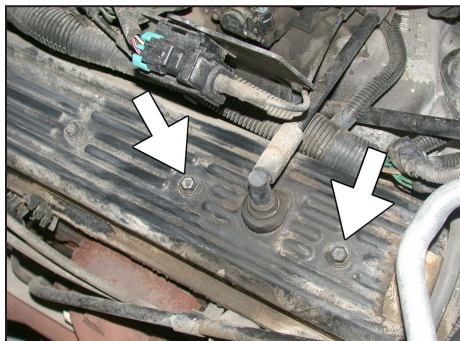

15. Remove the two valve cover bolts as shown.

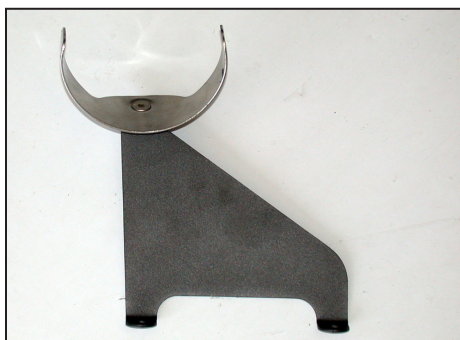

16. Assemble the saddle bracket assembly with the provided hardware as shown.



17. Install the saddle bracket assembly using the two bolts removed in step 15.



18. Remove the paper backing from the provided gasket and install the gasket onto the throttle body sticky side down.



19. Install the K&N® intake tube onto the throttle body.

NOTE: To set proper gasket compression, set the gap between the tube and the throttle body at 1/8". It may be necessary to adjust the nylock nuts several times to get the proper gap around the entire circumference. Each full turn of the nylock nut is equal to .050" up or down movement. Remove the tube when the proper gap has been achieved. Due to factory tolerances, it may be necessary to bend the EGR solenoid bracket downward to gain clearance for the K&N® intake tube.



20. Reinstall the K&N® intake tube and secure it with the provided washers and nylock nuts.



21. Secure the K&N® intake tube to the saddle bracket assembly with the provided hose clamp.



22. Install the K&N® air filter onto the K&N® intake tube as shown.



23. Assemble the silicone hose and hose mender as shown.

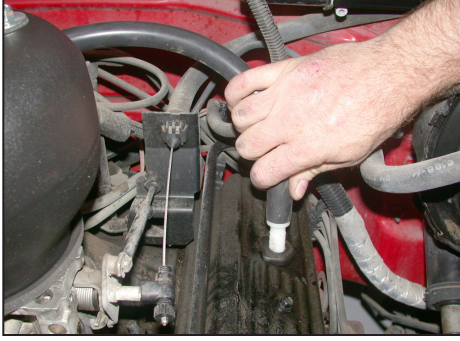

24. Install the silicone hose onto the vent on the K&N® intake tube, then push the hose mender into the grommet on the valve cover.



25. Reconnect the vehicle's negative battery cable. Double check to make sure everything is tight and properly positioned before starting the vehicle.

26. The C.A.R.B. exemption sticker, (attached), must be visible under the hood, so the emissions inspector can see it when the vehicle is required to be tested for emissions. California requires testing every two years, other states may vary.

27. **NOTE:** Most General Motors vehicles have the Vehicle Emissions Certification Information (VECI) label affixed to the air filter box. In order to be compliant with California emissions laws, the label **MUST** remain in the engine compartment. If the Vehicle Emission Control Information label is removed during modification, a new replacement label must be obtained and installed in a readily visible position in the engine compartment. The label shall not be affixed to any equipment which is easily detached from the vehicle. We recommend that the label is affixed to the underside of the hood adjacent to the hood latch. The label is Vehicle Identification Number dependent and can be ordered from the vehicle dealership. In order to receive the proper decal please bring your VIN with you. Failure to have the VECI under the hood may result in failure of a pre-registration smog test.

28. It will be necessary for all K&N® high flow intake systems to be checked periodically for realignment, clearance and tightening of all connections. Failure to follow the above instructions or proper maintenance may void warranty.

ROAD TESTING:

1. Start the engine with the transmission in neutral or park, and the parking brake engaged. Listen for air leaks or odd noises. For air leaks secure hoses and connections. For odd noises, find cause and repair before proceeding. This kit will function identically to the factory system except for being louder and much more responsive.

2. Test drive the vehicle. Listen for odd noises or rattles and fix as necessary.

3. If road test is fine, you can now enjoy the added power and performance from your kit.

4. K&N Engineering, Inc., requires cleaning the intake system's air filter element every 100,000 miles. When used in dusty or off-road environments, our filters will require cleaning more often. We recommend that you visually inspect your filter once every 25,000 miles to determine if the screen is still visible. When the screen is no longer visible some place on the filter element, it is time to clean it. To clean and re-oil, purchase our filter Recharger® service kit, part number 99-5050 or 99-5000 and follow the easy instructions.

INTAKE SYSTEMS FOR VEHICLES LISTED ARE 50 STATE LEGAL. SEE KNFILTERS.COM FOR CARB STATUS ON EACH PART FOR A SPECIFIC VEHICLE.