



INTAKE SYSTEMS FOR VEHICLES LISTED ARE 50 STATE LEGAL. SEE KNFILTERS.COM FOR CARB STATUS ON EACH PART FOR A SPECIFIC VEHICLE.

INSTALLATION INSTRUCTIONS

57-2543
FORD
***1994-96 F-150**
***1994-96 BRONCO**
V8-5.0 / 5.8L

*Vehicles that come equipped with mass air sensor.

NOTE: This kit was not designed to fit vehicles with a body lift.

TOOLS NEEDED:

- Flat Blade Screwdriver
- Drill
- 1/4 Drill Bit
- Ratchet
- Extension
- 13mm Socket
- 10mm Socket
- 8mm Socket
- 10mm wrench
- 5mm Allen

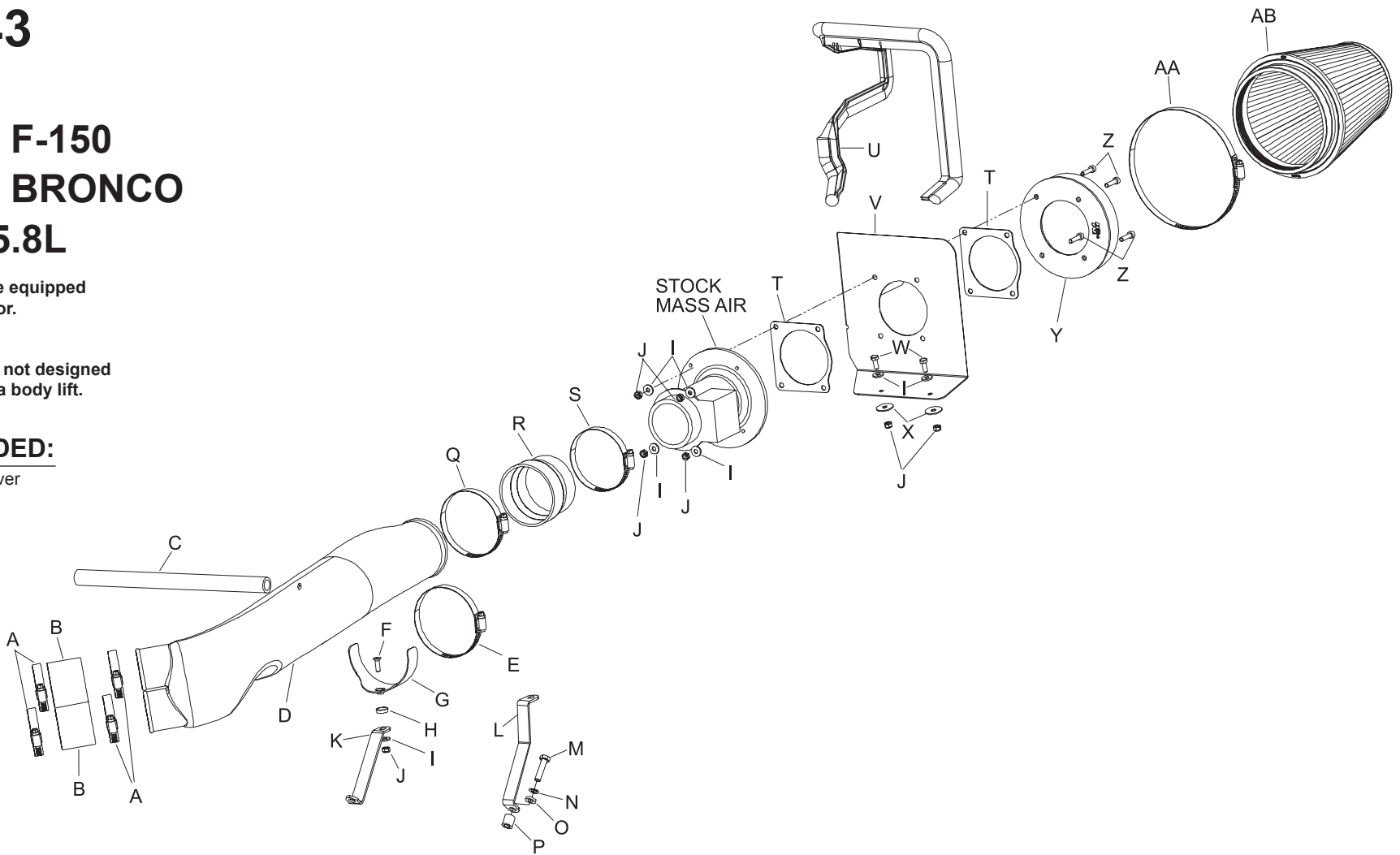

PARTS LIST:

Description	Qty.	Part #	Description	Qty.	Part #	Description	Qty.	Part #
A Hose Clamp #36	4	08530	J Nylock Nut	7	07553	S Hose Clamp #52	1	08610
B Silicone Hose	2	08405	K Bracket	1	07164	T Gasket	2	09330
C Vent Hose	1	08602	L Bracket	1	07165	U Edge Trim 39"L	1	102496
D Intake Tube (CP)	1	087085	M Hex Bolt	1	07784	V Heat Shield	1	074002
E Hose Clamp #60	1	08624	N Wave Washer	1	08239	W Hex Bolt	2	07703
F bolt; 6mm-1.00	1	08376	O Flat Washer	1	08276	X Fender Washer	2	08160
G Saddle Bracket	1	078855	P Spacers	1	07849	Y Adapter #200	1	08831
H Washer; Conical, Nylon, Black	1	08180	Q Hose Clamp #56	1	08620	Z Allen Bolt	4	07859
I Flat Washer	7	08275	R Step Hose	1	08051	AA Hose Clamp #104	1	08697
						AB Air Filter	1	RF-1041

NOTE: FAILURE TO FOLLOW INSTALLATION INSTRUCTIONS AND NOT USING THE PROVIDED HARDWARE MAY DAMAGE THE INTAKE TUBE, THROTTLE BODY AND ENGINE.

TO START:

1. Turn off the ignition and disconnect the negative battery cable.
NOTE: Disconnecting the negative battery cable erases pre-programmed electronic memories. Write down all memory settings before disconnecting the negative battery cable. Some radios will require an anti-theft code to be entered after the battery is reconnected. The anti-theft code is typically supplied with your owner's manual. In the event your vehicles' anti-theft code cannot be recovered, contact an authorized dealership to obtain your vehicles anti-theft code.



2. Disconnect the mass air sensor electrical connection.

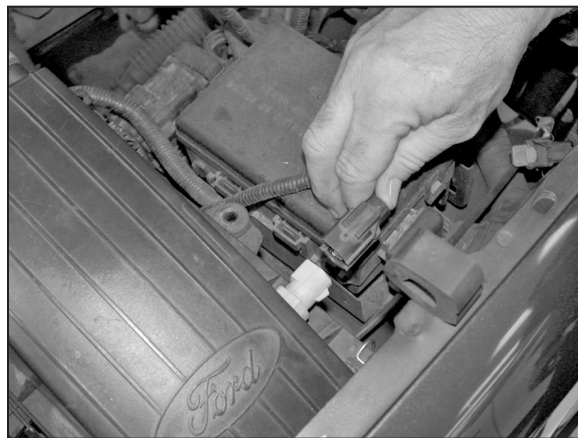

3. Disconnect the temp sensor electrical connection.



4. Loosen the hose clamp that secures the crank case vent to the valve cover then remove hose.



5. Loosen the three hose clamps that secure the intake tube to the air box and throttle body then remove the intake tube.



6. Remove the fresh air intake tube from the bottom of air box as shown.



7. Remove the three bolts that secure the air box to the vehicle then remove air box from vehicle.
NOTE: K&N Engineering, Inc., recommends that customers do not discard factory air intake.

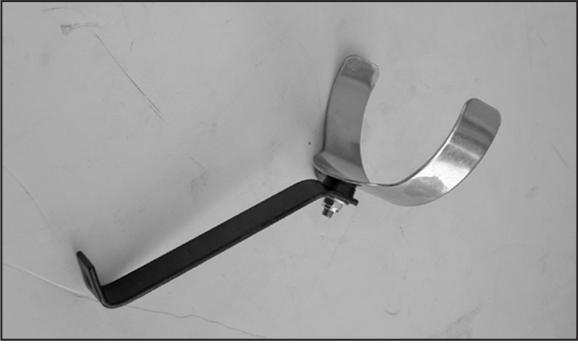

8. On vehicles that come equipped with A/C, assemble the saddle bracket onto bracket (07164) as shown.



8a. On vehicles that do not come equipped with A/C, assemble the saddle bracket onto bracket (07165) as shown.

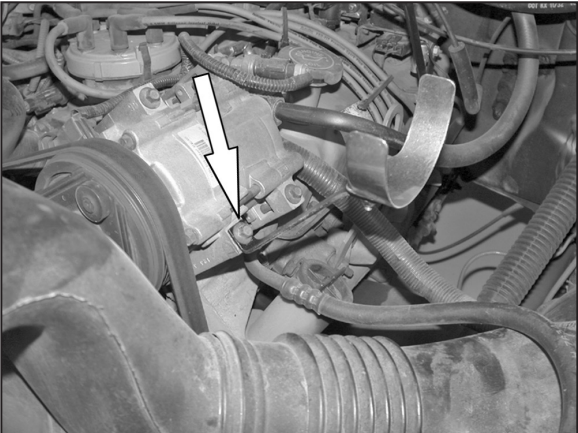

9. On vehicles that come equipped with A/C, remove the front lower A/C mounting bolt. Then secure the saddle bracket assemble from step 8 onto vehicle as shown.

NOTE: On 5.0L models use the provided spacer (07849) under bracket when mounting to vehicle.



9a. On vehicles that do not come equipped with A/C, mount the saddle bracket assembly from step 8a onto the idler pulley bracket as shown.
NOTE: On 5.0L models use the provided spacer (07849) under bracket when mounting to vehicle.

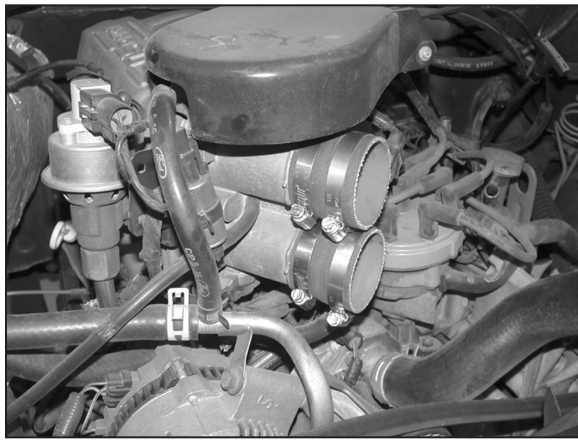

10. Secure the provided silicone hoses (08405) onto the throttle body with the provided hose clamps as shown.



11. Install edge trim onto heat shield as shown. Trim if needed.

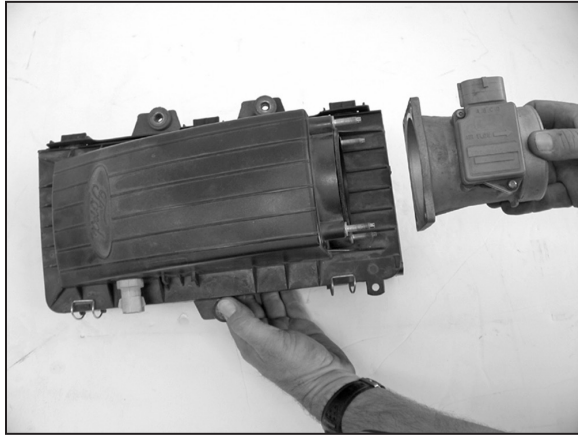

12. Remove the mass air sensor from the factory airbox as shown.

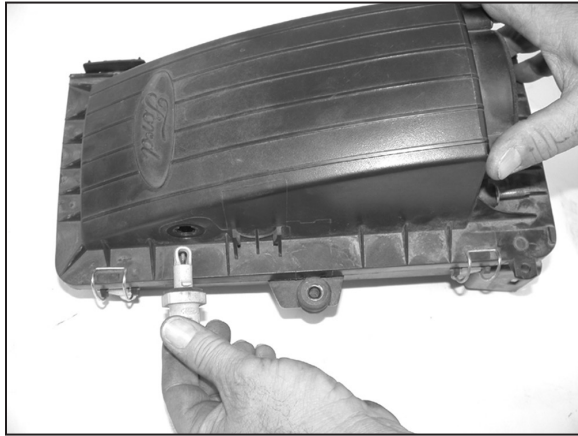

13. Twist the temp sensor counter clock wise to remove from the factory airbox.



14. Assemble to mass air sensor to the heat shield and filter adaptor using the provided gaskets and hardware as shown.

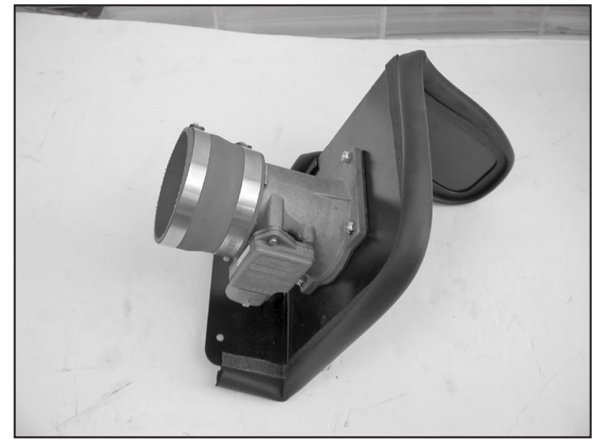

15. Install the silicone hose (08051) onto the mass air sensor with the provided hose clamps.



16. Install the new K&N® intake tube onto the throttle body, then secure the intake tube to the saddle bracket as shown.

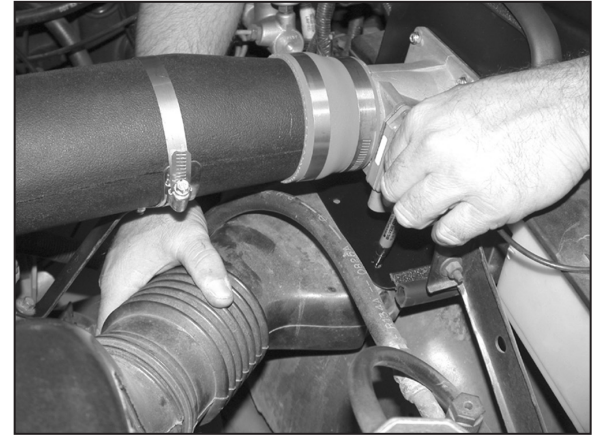

17. Install the mass air assembly onto the intake tube then line up the fresh air duct to the heat shield and mark the two holes with a marker.



18. Remove the mass air assembly and drill two 1/4" holes were marked in the previous step.

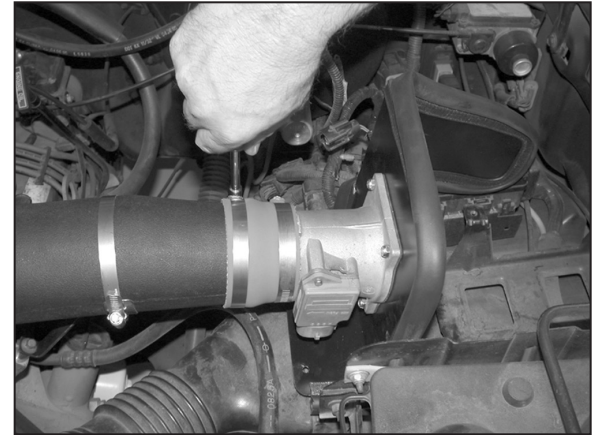

19. Reinstall the mass air assembly and secure with the provided hose clamps.

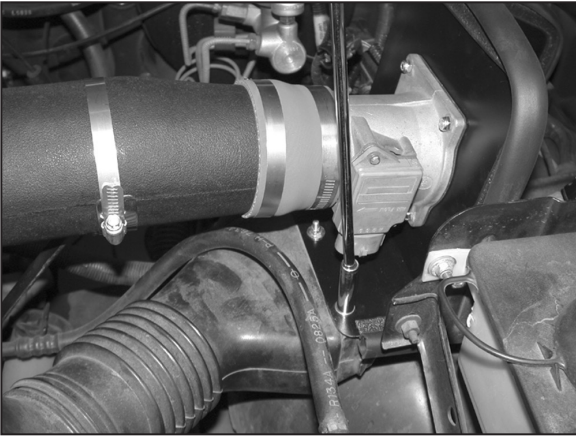

20. Mount the fresh air duct to the heat shield with the provided hardware.

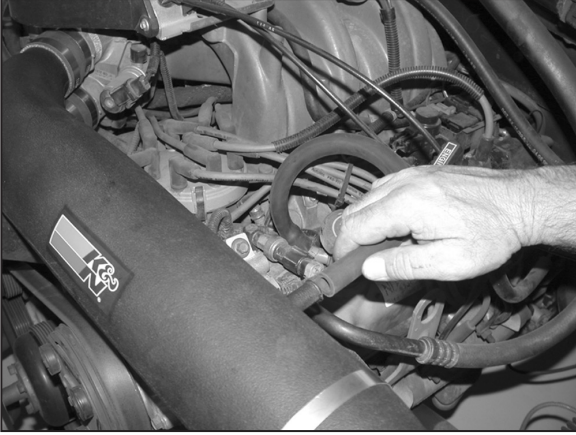

21. Reconnect the crank case vent onto the valve cover, then connect to the intake tube as shown. Trim hose for best fit.

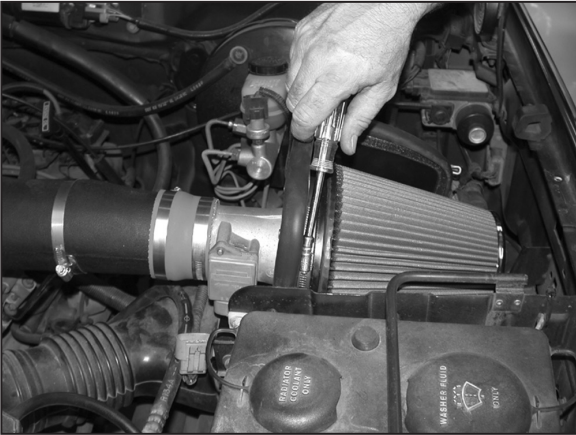

22. Install the Filtercharger to the mass air assembly as shown.

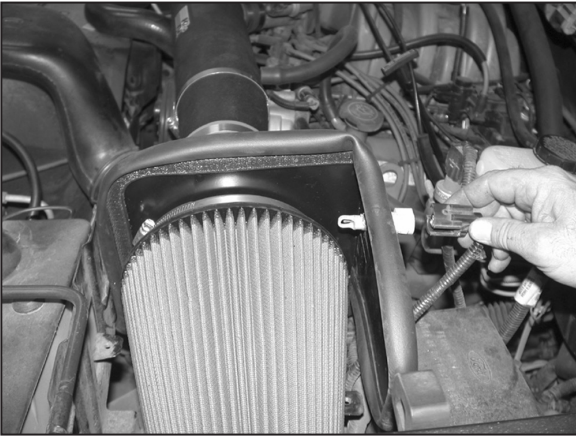

23. Install the temp sensor onto the heat shield then reconnect the electrical connection as shown.

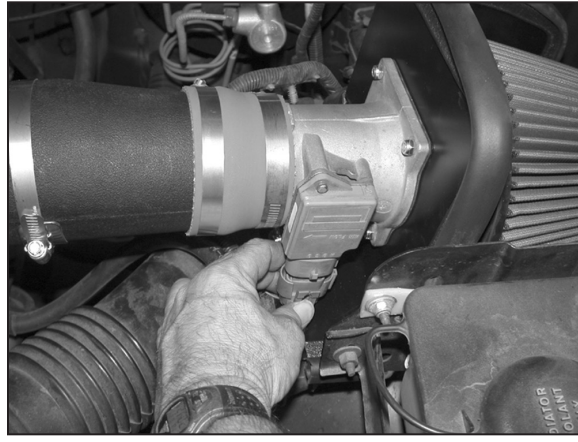

24. Reconnect the mass air sensor electrical connection as shown.



25. Reconnect the vehicle's negative battery cable. Double check to make sure everything is tight and properly positioned before starting the vehicle.

26. The C.A.R.B. exemption sticker, (attached), must be visible under the hood so that an emissions inspector can see it when the vehicle is required to be tested for emissions. California requires testing every two years, other states may vary.

27. It will be necessary for all K&N® high flow intake systems to be checked periodically for realignment, clearance and tightening of all connections. Failure to follow the above instructions or proper maintenance may void warranty.

ROAD TESTING:

1. Start the engine with the transmission in neutral or park, and the parking brake engaged. Listen for air leaks or odd noises. For air leaks secure hoses and connections. For odd noises, find cause and repair before proceeding. This kit will function identically to the factory system except for being louder and much more responsive.

2. Test drive the vehicle. Listen for odd noises or rattles and fix as necessary.

3. If road test is fine, you can now enjoy the added power and performance from your kit.

4. K&N Engineering, Inc., requires cleaning the intake system's air filter element every 100,000 miles. When used in dusty or off-road environments, our filters will require cleaning more often. We recommend that you visually inspect your filter once every 25,000 miles to determine if the screen is still visible. When the screen is no longer visible some place on the filter element, it is time to clean it. To clean and re-oil, purchase our filter Recharger® service kit, part number 99-5050 or 99-5000 and follow the easy instructions.

INTAKE SYSTEMS FOR VEHICLES LISTED ARE 50 STATE LEGAL. SEE KNFILTERS.COM FOR CARB STATUS ON EACH PART FOR A SPECIFIC VEHICLE.