



INTAKE SYSTEMS FOR VEHICLES LISTED ARE 50 STATE LEGAL. SEE KNFILTERS.COM FOR CARB STATUS ON EACH PART FOR A SPECIFIC VEHICLE.

INSTALLATION INSTRUCTIONS

57-2542

FORD

*1988-95 F-150 / BRONCO

V8-5.0L / 5.8L

*1989 F-250

V8-5.0L

* Vehicles that do not come equipped with mass air sensor.

NOTE: This kit was not designed to fit vehicles with a body lift.

TOOLS NEEDED:

- Flat Blade Screwdriver
- 5mm Allen
- 10mm Wrench
- 11mm Wrench
- 10mm Socket
- 13mm Socket
- Ratchet
- Extension
- Drill
- 1/4 Drill Bit

PARTS LIST:

Description	Qty.	Part #	Description	Qty.	Part #	Description	Qty.	Part #
A hose clamp, #36	4	08530	I 8mm wave washer	1	08239	Q Heat shield	1	074008
B hose, 2-3/8" id X 2" L	2	08405	J 8mm X 1.25 X 35mm bolt	1	07784	R Edge trim 30"L	1	102489
C K&N intake tube (CP) long	1	087082	K 6mm nuts, nylock	5	07553	S bolt; 6mm-1.00 X 20mm hex	4	07865
D hose, 5/8" X 13" L, black	1	08602	L 1/4" id X 5/8" od flat washer	7	08275	T fender washer, 1/4" id X 1" od	2	08160
E support bracket, w/out A/C	1	07165	M nylon cup washer; black	1	08180	U bracket (L)	1	070932
F support bracket, with A/C	1	07164	N bolt; 6mm f/h/a	1	08376	V bracket (L)	1	07879
G spacer, .625" od X .375" long	1	07849	O saddle bracket	1	078855	W air filter	1	RC-3690
H 5/16" id X 5/8" od flat washer	1	08276	P hose clamp, #60	1	08628	X hose clamp #60 ss	1	08624

NOTE: FAILURE TO FOLLOW INSTALLATION INSTRUCTIONS AND NOT USING THE PROVIDED HARDWARE MAY DAMAGE THE INTAKE TUBE, THROTTLE BODY AND ENGINE.

TO START:

1. Turn off the ignition and disconnect the negative battery cable.
NOTE: Disconnecting the negative battery cable erases pre-programmed electronic memories. Write down all memory settings before disconnecting the negative battery cable. Some radios will require an anti-theft code to be entered after the battery is reconnected. The anti-theft code is typically supplied with your owner's manual. In the event your vehicles' anti-theft code cannot be recovered, contact an authorized dealership to obtain your vehicles anti-theft code.

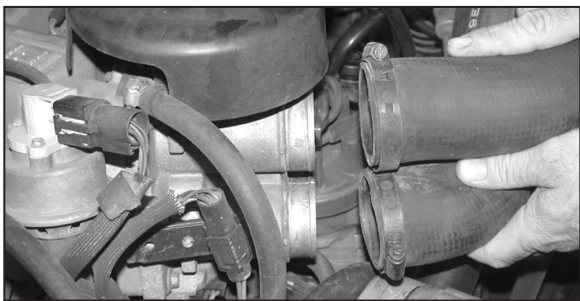

2. Loosen the two hose clamps at the throttle body, then remove the two intake tubes from the throttle body as shown.



3. Loosen the two hose clamps at the airbox then remove the two intake tubes from the air box as shown.



4. Remove the fresh air intake tube from the bottom of air box as shown.

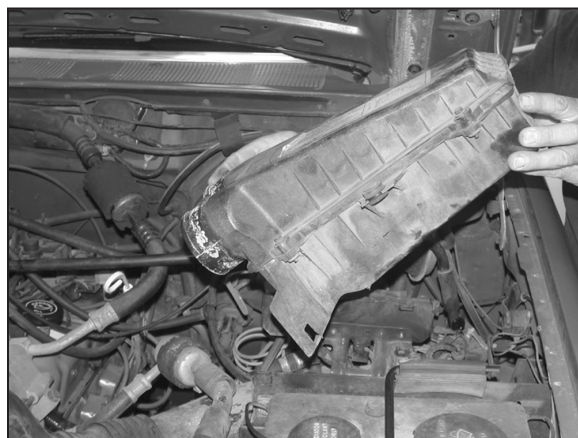

5. Remove the crank case vent from air box then remove the two 8mm bolts that retain the air box to vehicle. Then remove air box from vehicle as shown.

NOTE: K&N recommends that customers do not discard factory air intake



6. On vehicles that come equipped with A/C, assemble the saddle bracket onto bracket (07164) as shown.



6a. On vehicles that do not come equipped with A/C, assemble the saddle bracket onto bracket (07165) as shown.

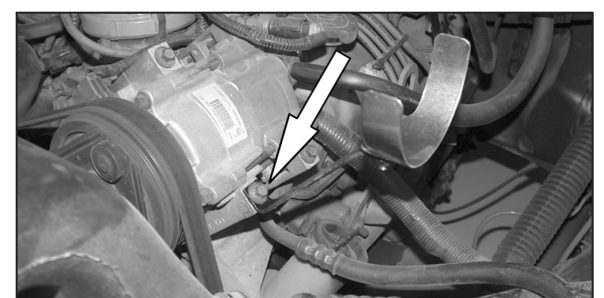

7. On vehicles that come equipped with A/C, remove the front lower A/C mounting bolt. Then secure the saddle bracket assembly from step 6 onto vehicle as shown.

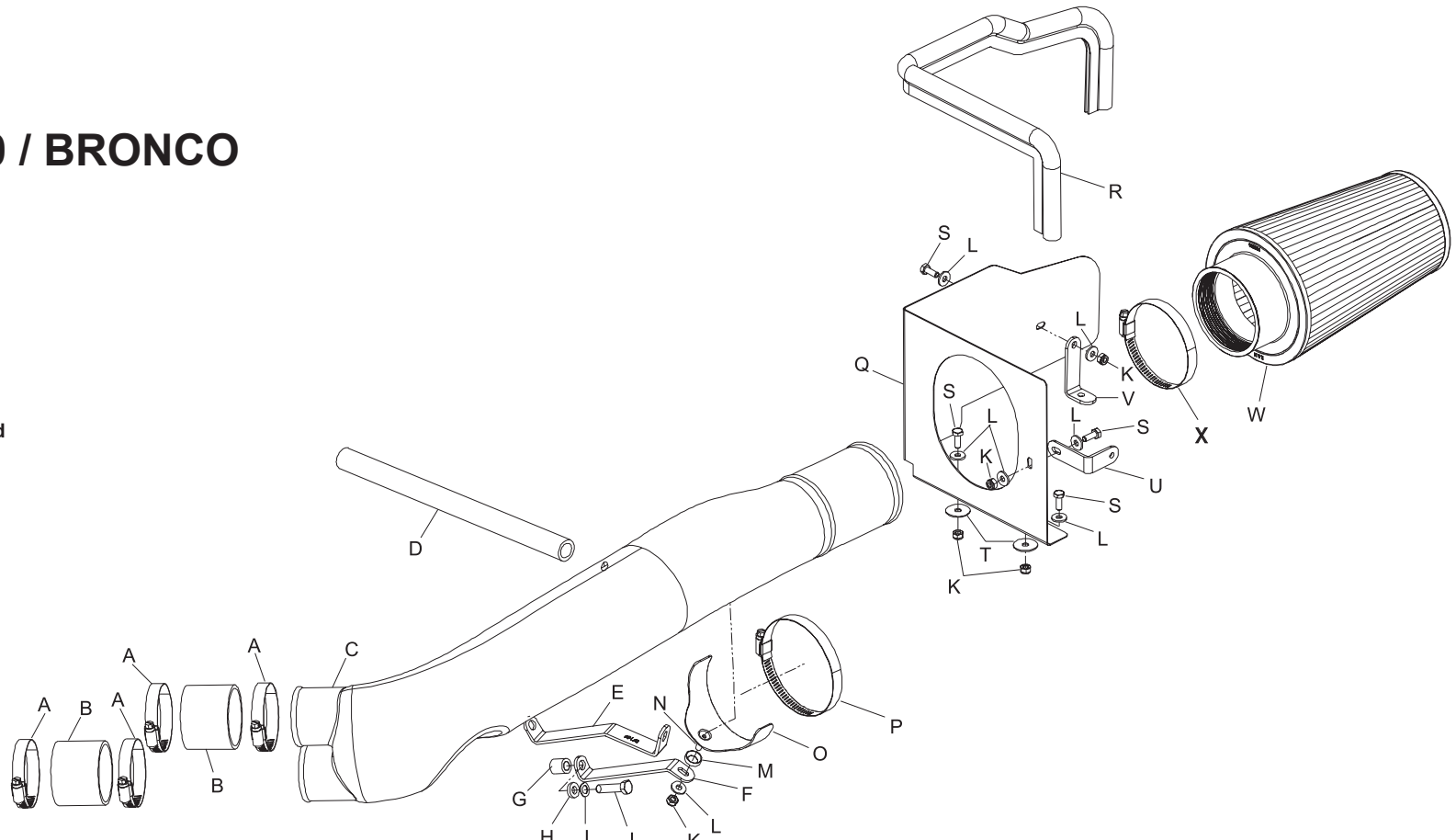

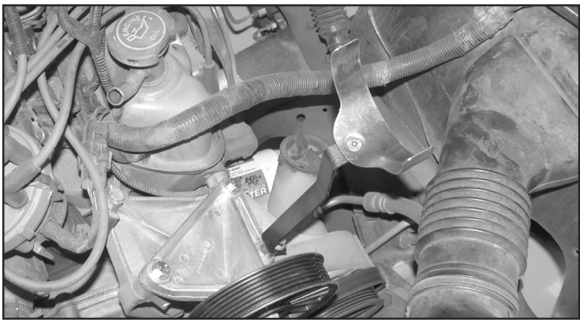

7a. On vehicles that do not come equipped with A/C, mount the saddle bracket assembly from step 6a onto the idler pulley bracket as shown.

NOTE: Be sure to place the provided spacer (07849) under the bracket.

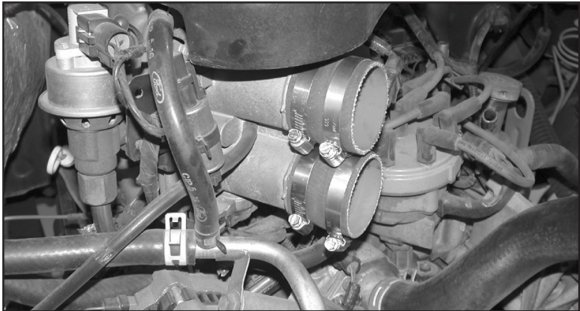

8. Secure the provided silicone hoses (08405) onto the throttle body with the provided hose clamps as shown.

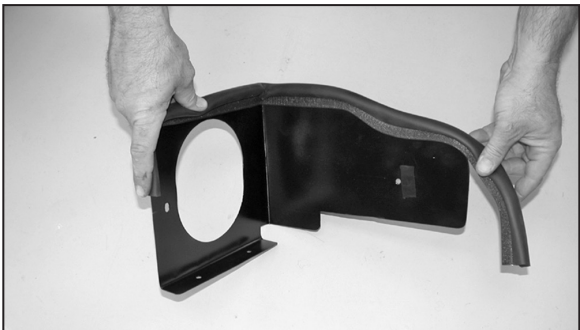

9. Install edge trim onto heat shield as shown. Trim if needed.



10. Install the provided bracket (07879) onto the air box mounting bracket as shown using one of the bolts that was removed in step 5.



10a. On vehicles that come with a relay mounting bracket cut the two tabs off for heat shield clearance as shown.



11. Remove the nut that retains the coolant tank to vehicle then mount the provided bracket (070932) to tank with the nut that was removed.



12. Install the heat shield onto the vehicle then line up the fresh air duct to the heat shield and mark the two holes with a marker, then remove heat shield from vehicle.



13. Remove the heat shield and drill two 1/4" holes were you marked in the previous step.



14. Re-install the heat shield onto the vehicle then mount the fresh air duct to the heat shield with the provided hardware as shown.



15. Install the new K&N® intake tube onto the throttle body, then secure the intake tube to the saddle bracket as shown.

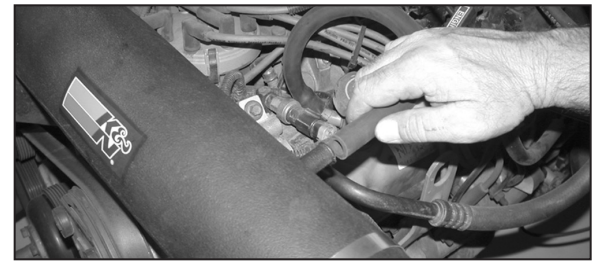

16. Remove the crank case vent tube from valve cover then connect the provided silicone hose to the valve cover, then connect to the intake tube as shown. Trim hose for best fit.

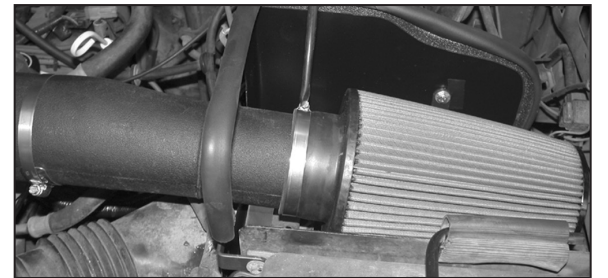

17. Install the air filter onto the new intake tube as shown.



18. Reconnect the vehicle's negative battery cable. Double check to make sure everything is tight and properly positioned before starting the vehicle.

19. The C.A.R.B. exemption sticker, (attached), must be visible under the hood so that an emissions inspector can see it when the vehicle is required to be tested for emissions. California requires testing every two years, other states may vary.

20. It will be necessary for all K&N® high flow intake systems to be checked periodically for realignment, clearance and tightening of all connections. Failure to follow the above instructions or proper maintenance may void warranty.

ROAD TESTING:

1. Start the engine with the transmission in neutral or park, and the parking brake engaged. Listen for air leaks or odd noises. For air leaks secure hoses and connections. For odd noises, find cause and repair before proceeding. This kit will function identically to the factory system except for being louder and much more responsive.

2. Test drive the vehicle. Listen for odd noises or rattles and fix as necessary.

3. If road test is fine, you can now enjoy the added power and performance from your kit.

4. K&N Engineering, Inc., requires cleaning the intake system's air filter element every 100,000 miles. When used in dusty or off-road environments, our filters will require cleaning more often. We recommend that you visually inspect your filter once every 25,000 miles to determine if the screen is still visible. When the screen is no longer visible some place on the filter element, it is time to clean it. To clean and re-oil, purchase our filter Recharger® service kit, part number 99-5050 or 99-5000 and follow the easy instructions.

INTAKE SYSTEMS FOR VEHICLES LISTED ARE 50 STATE LEGAL. SEE KNFILTERS.COM FOR CARB STATUS ON EACH PART FOR A SPECIFIC VEHICLE.