



INTAKE SYSTEMS FOR VEHICLES LISTED ARE 50 STATE LEGAL. SEE KNFILTERS.COM FOR CARB STATUS ON EACH PART FOR A SPECIFIC VEHICLE.

# INSTALLATION INSTRUCTIONS

**57-2536**  
**FORD**  
**1995-97 Explorer**  
**V6-4.0L OHV**

**NOTE:** This kit was not designed for vehicles with body lifts.

**TOOLS NEEDED:**

- Flat blade screwdriver
- 8mm wrench
- 10mm wrench
- 13mm allen wrench
- 5mm allen wrench
- 4mm allen wrench
- Drill
- 11/16" drill bit

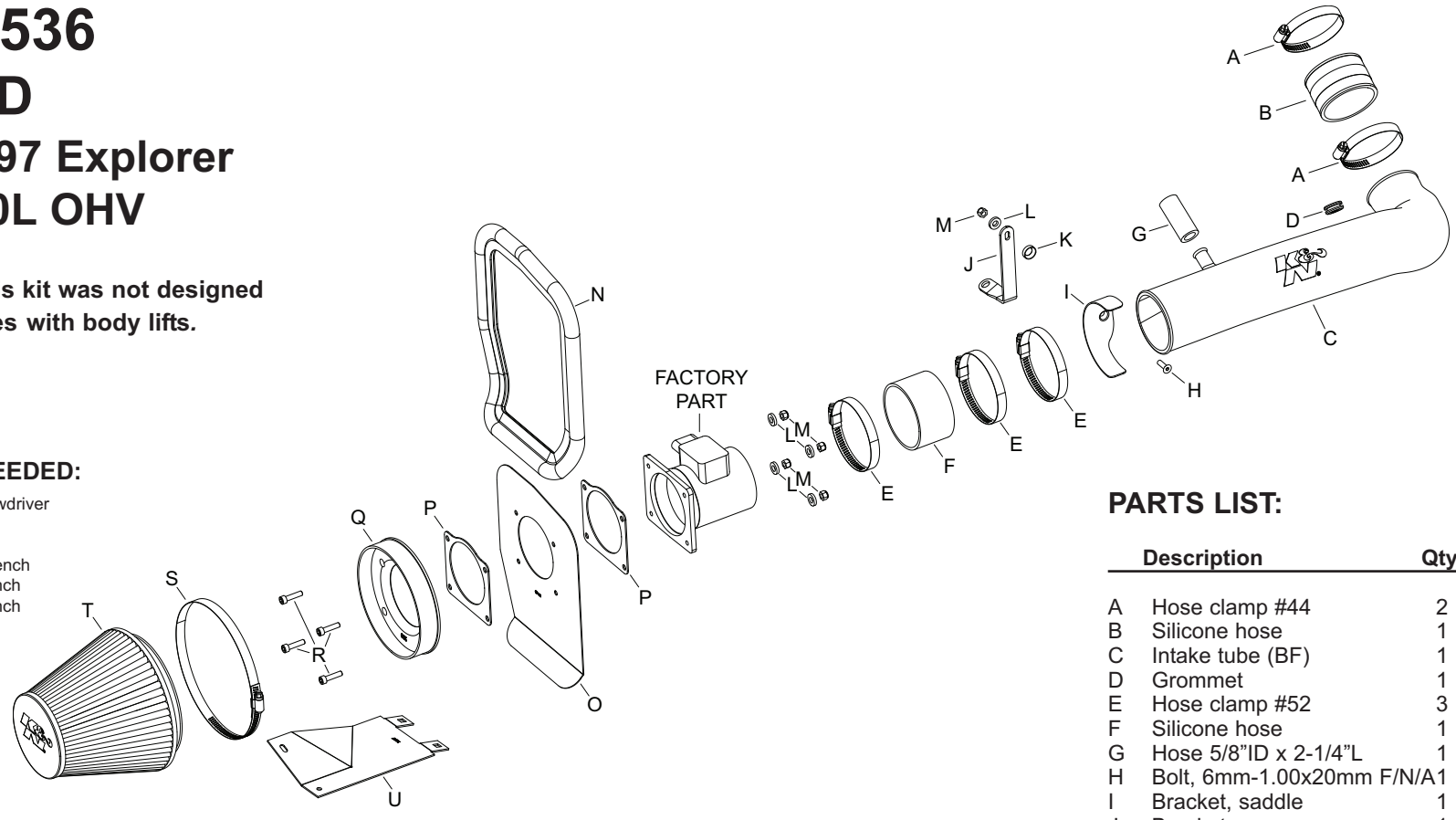

**PARTS LIST:**

Description	Qty.	P/N
A Hose clamp #44	2	08577
B Silicone hose	1	08756
C Intake tube (BF)	1	087008
D Grommet	1	08092
E Hose clamp #52	3	08610
F Silicone hose	1	08690
G Hose 5/8"ID x 2-1/4"L	1	08692
H Bolt, 6mm-1.00x20mm F/N/A1	1	08376
I Bracket, saddle	1	078855
J Bracket	1	26616
K Washer, conical	1	08180
L Washer, 1/4"ID	5	08275
M Nut, 6mm nylock	5	07553
N Edge trim 33"L	1	102498
O Heat shield	1	07444
P Gasket	2	09330
Q Mass air adapter (200)	1	08831
R Bolt, 6mm-1.00x25 allen	4	07859
S Hose clamp #104	1	08697
T Filtercharger	1	RF-1048
U Relay bracket	1	26617

**NOTE: FAILURE TO FOLLOW INSTALLATION INSTRUCTIONS AND NOT USING THE PROVIDED HARDWARE MAY DAMAGE THE INTAKE TUBE, THROTTLE BODY AND ENGINE.**

**TO START:**

1. Turn the ignition OFF and disconnect the vehicle's negative battery cable.

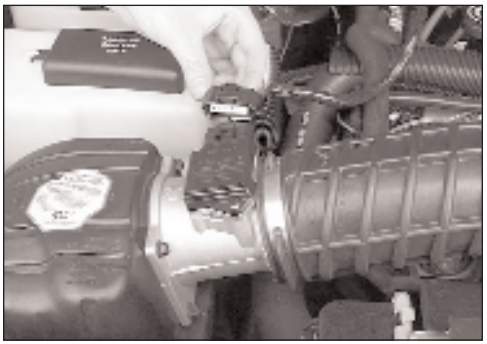

2. Disconnect the mass air sensor electrical connection.



3. On models that come equipped with an air temp sensor, disconnect electrical connection.

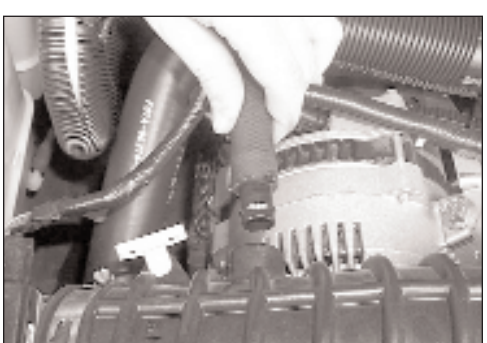

4. Remove the crankcase vent hose as shown.

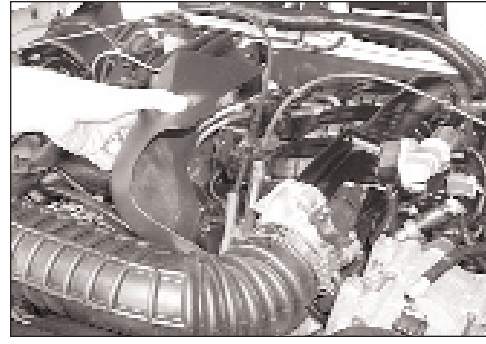

5. Loosen and remove the two bolts that secure the throttle linkage cover, then remove the cover as shown.

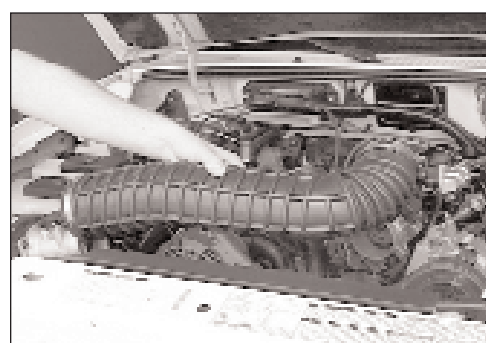

6. Loosen the hose clamps at the throttle body and at the airbox, then remove the air intake tube as shown.



7. Pry center of push-clip up then remove the airbox retaining clip as shown.



8. Pull firmly up on airbox to release airbox from grommets on the lower support bracket assembly.

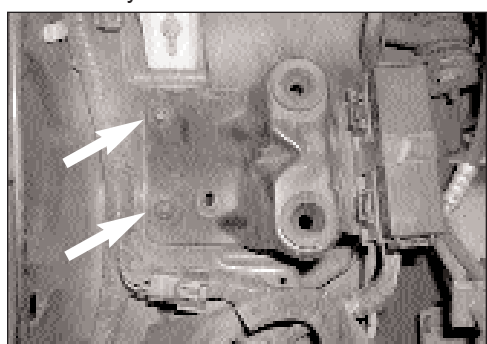

9. On vehicles that come equipped with relay switches mounted under airbox, remove the two bolts that retain the airbox mounting bracket.

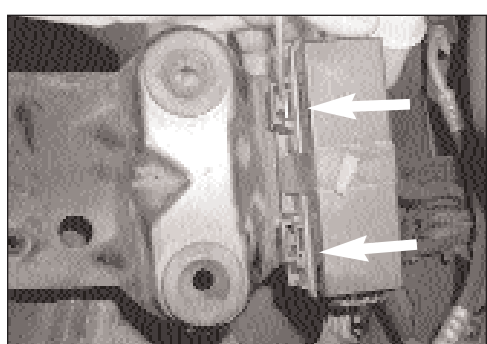

10. Use a flat blade screw driver to release clips then remove relays from bracket.

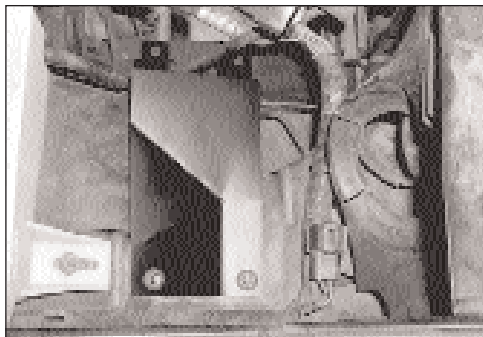

11. Using the bolts that were removed in step 9, install new relay bracket as shown.



12. Re-install relays onto the new relay bracket as shown.

**NOTE: Make sure clips snap into position.**



13. Pull rubber boot back away from airbox. Depress tab with screwdriver as shown to release electrical connection.



14. Using a flat blade screwdriver, depress tabs on cover to remove mass air sensor.



15. Loosen and remove the nuts from the mass air sensor.

**NOTE: It may be necessary to use vise grips to secure studs.**

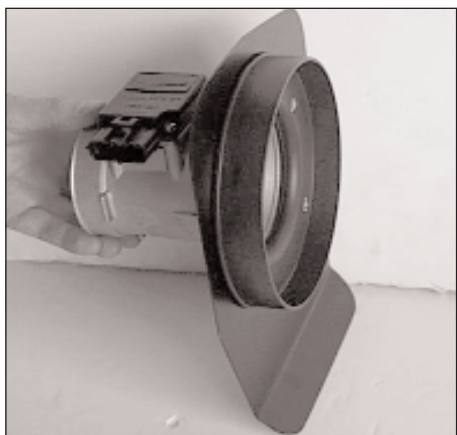

16. Using the provided hardware, assemble the mass air adapter, gas-gaskets, heat shield and mass air sensor as shown.



17. Apply the trim seal to the heat shield assembly as shown.

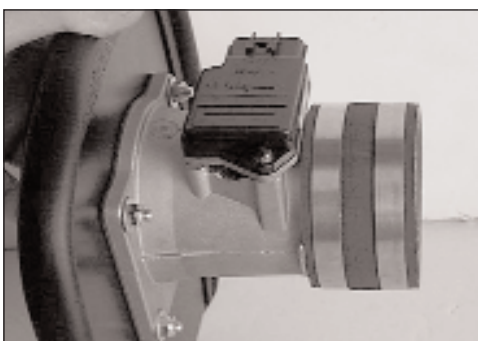

18. Install the silicone hose and hose clamps onto the heat shield assembly as shown.



19. Install the silicone hose and hose clamps onto the throttle body as shown.

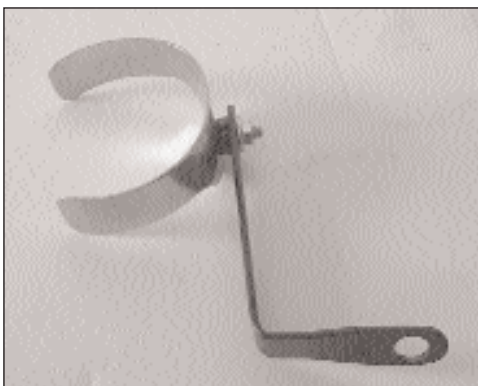

20. Using the provided hardware, assemble the saddle bracket assembly as shown.

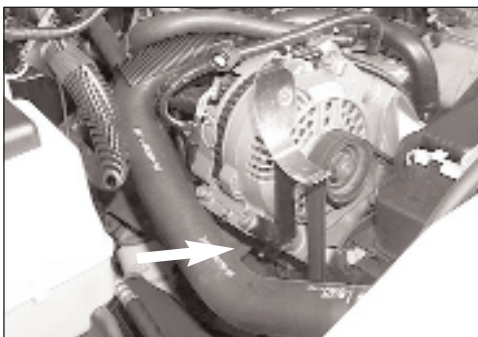

21. Remove the front lower alternator bolt, then secure the saddle bracket assembly using the same bolt as shown.

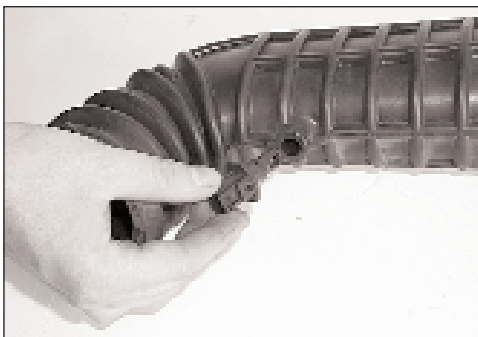

22. On models equipped with an external air temp. sensor, remove the air temp. sensor from the factory intake tube as shown.

**NOTE: If vehicle did not come equipped with an air temp sensor, go to step 22.**

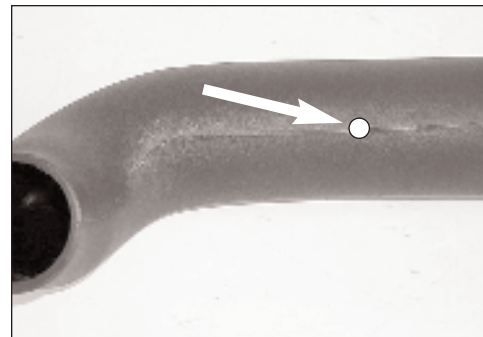

23. On models equipped with an external air temp sensor, drill out the drill point in the K&N® intake tube using a 11/16" drill bit.



24. Install the provided grommet onto the K&N® intake tube as shown.

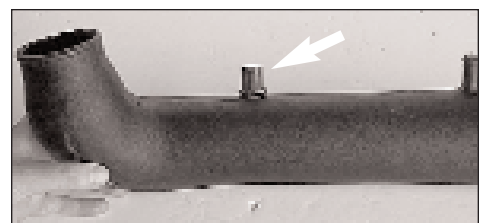

25. Install the air temp. sensor into the grommet in the K&N® intake tube as shown.

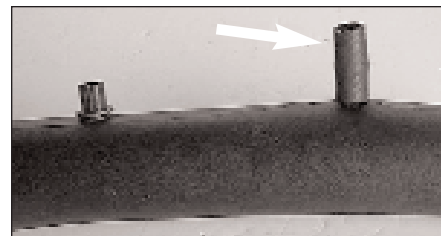

26. Install the rubber hose onto the vent on the K&N® intake tube as shown.



27. Install the K&N® intake tube onto the throttle body and secure as shown.



28. Using the provided hose clamp, secure the K&N® intake tube to the saddle bracket assembly as shown.

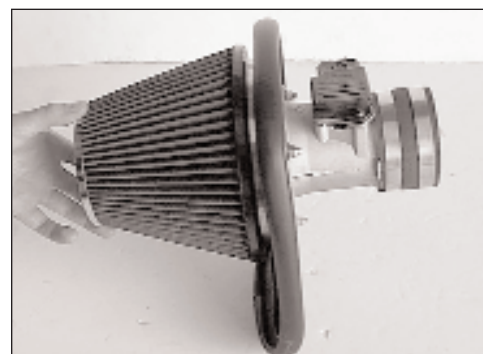

29. Install the K&N® Filter onto the heat shield assembly as shown.



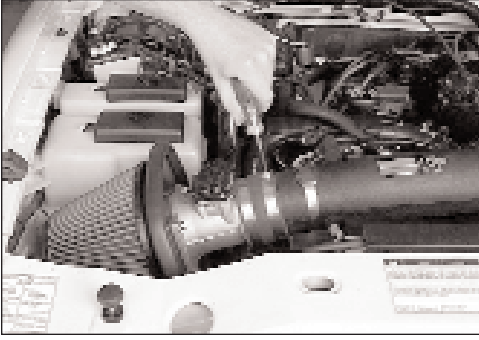

30. Install the heat shield assembly onto the K&N® intake tube and tighten the hose clamp as shown.

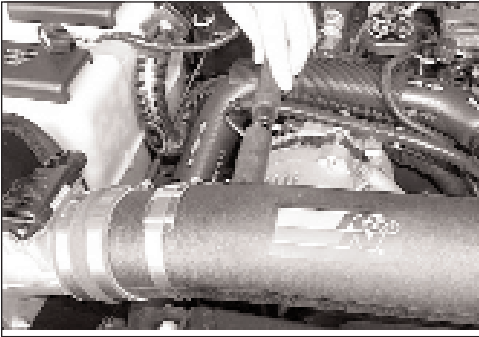

31. Reconnect the crankcase vent hose as shown.

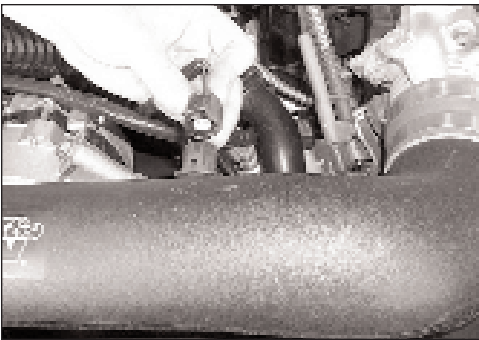

32. Reconnect the air temp sensor electrical connection as shown.

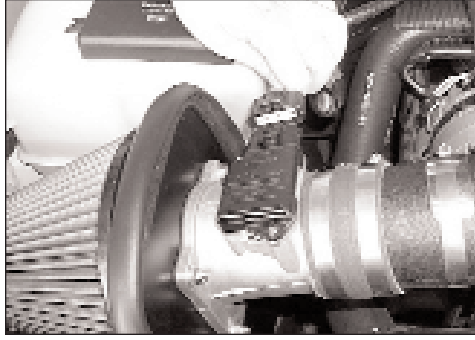

33. Reconnect the mass air sensor electrical connection as shown.



34. Re-install the throttle linkage cover as shown.

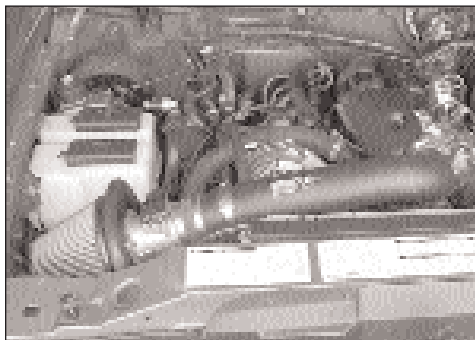

35. Reconnect the vehicle's negative battery cable. Double check to make sure everything is tight and properly positioned before starting the vehicle.

36. The C.A.R.B. exemption sticker, (attached), must be visible under the hood so that an emissions inspector can see it when the vehicle is required to be tested for emissions. California requires testing every two years, other states may vary.

37. It will be necessary for all F.I.P.K.'s to be checked periodically for realignment, clearance and tightening of all connections. Failure to follow the above instructions or proper maintenance may void warranty.

#### **ROAD TESTING:**

1. Start the engine with the transmission in neutral or park, and the parking brake engaged. Listen for air leaks or odd noises. For air leaks secure hoses and connections. For odd noises, find cause and repair before proceeding. This kit will function identically to the factory system except for being louder and much more responsive.

2. Test drive the vehicle. Listen for odd noises or rattles and fix as necessary.

3. If road test is fine, you can now enjoy the added power and performance from your kit.

4. K&N suggests checking the Filtercharger element periodically for excessive dirt build-up. When the element becomes covered in dirt (or once a year), service it according to the instructions on the Recharger service kit, part number 99-5050 or 99-5000.

**INTAKE SYSTEMS FOR VEHICLES LISTED ARE 50 STATE LEGAL. SEE KNFILTERS.COM FOR CARB STATUS ON EACH PART FOR A SPECIFIC VEHICLE.**

**\*FREE K&N DECAL To register your warranty, please see us online at [knfilters.com/register](http://knfilters.com/register). FREE K&N DECAL\***